

Tactile Switch (Hinged Type)

B3J

Hinged Design Developed through Ergonomics

- Quick, superior snap action through hook-type hinge construction.
- Available with 1 or 2 LEDs or without LEDs.
- The hinge button is available in a wide variety of colors (five standard colors).
- RoHS Compliant.

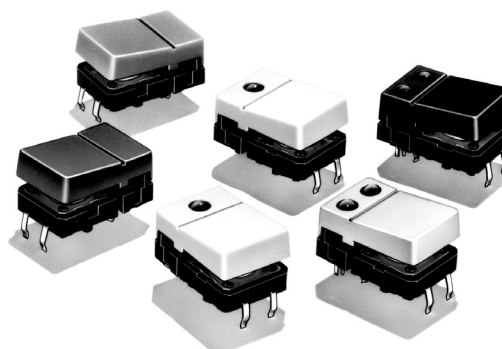

Ordering Information

Color of hinged button	No LED	One LED			Two LEDs (left and right)		
		Red	Yellow	Green	Red/Yellow	Red/Green	Yellow/Green
Light gray	B3J-1000	B3J-2000	B3J-3000	B3J-4000	B3J-5000	B3J-6000	B3J-7000
Black	B3J-1100	B3J-2100	B3J-3100	B3J-4100	B3J-5100	B3J-6100	B3J-7100
Orange	B3J-1200	B3J-2200	B3J-3200	B3J-4200	B3J-5200	B3J-6200	B3J-7200
Yellow	B3J-1300	B3J-2300	B3J-3300	B3J-4300	B3J-5300	B3J-6300	B3J-7300
Blue	B3J-1400	B3J-2400	B3J-3400	B3J-4400	B3J-5400	B3J-6400	B3J-7400

Specifications

■ Ratings/Characteristics

Contact form	SPST-NO
Switching capacity	1 to 50 mA, 5 to 24 VDC (resistive load)
Contact resistance	100 mΩ max. (rated: 1 mA, 5 VDC)
Insulation resistance	100 MΩ min. (at 250 VDC)
Dielectric strength	500 VAC, 50/60 Hz for 1 min.
Bounce time	5 ms max.
Vibration resistance	Malfunction: 10 to 55 Hz, 1.5-mm double amplitude
Shock resistance	Destruction: 1,000 m/s ² (approx. 100 G) max. Malfunction: 100 m/s ² (approx. 10 G) max.
Life expectancy	3,000,000 operations min.
Ambient operating temperature	-25°C to 70°C (at 60% RH max.) with no icing or condensation
Ambient operating humidity	35% to 85% (at 5 to 35°C)
Weight	Approx. 1.5 to 1.7 g

■ Operating Characteristics

Operating force (OF)	1.27±0.49 N (130 ± 50 gf)
Releasing force (RF)	0.29 N (30 gf) min.
Pretravel (PT)	0.3 ^{+0.2} / _{-0.1} mm

■ Built-in LED Performance

Item		Red	Yellow	Green
Forward voltage V_F	Standard value (V)	2.0	2.0	2.1
Forward current I_F	Standard value (mA)	20	20	20
Permissible loss P	Absolute maximum value (mW)	84	84	84
Reverse voltage V_R	Absolute maximum value (V)	5	5	5

Note: Since the built-in LED does not contain any limiting resistors, externally connect limiting resistors within the limits shown in the above table.

Engineering Data

**Operating Force vs. Stroke
(Typical)**

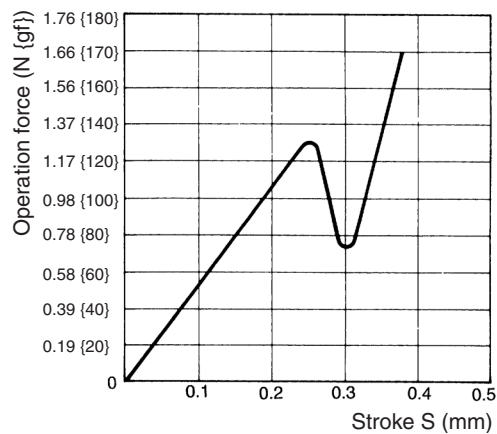

Dimensions

All units are in millimeters unless otherwise indicated. Unless otherwise specified, a tolerance of ± 0.4 mm applies to all dimensions.

Types with no LED

B3J-1□00

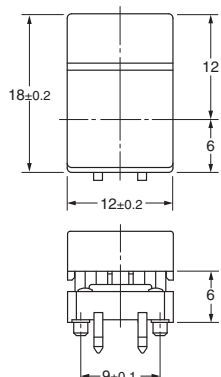
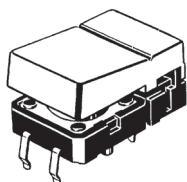

PCB Mounting (Top View)

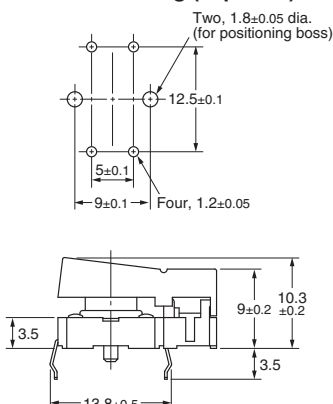

Panel Cutout

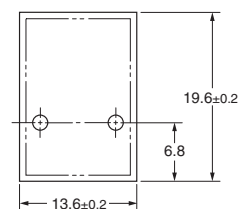

Terminal Arrangement / Internal Connections (Top View)

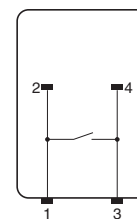

1 LED Types

B3J-2□00
B3J-3□00
B3J-4□00

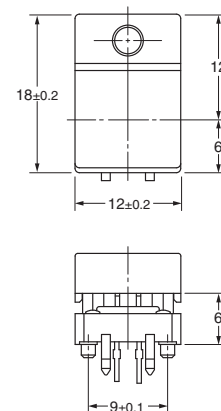
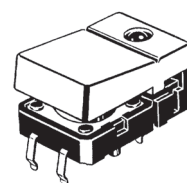

PCB Mounting (Top View)

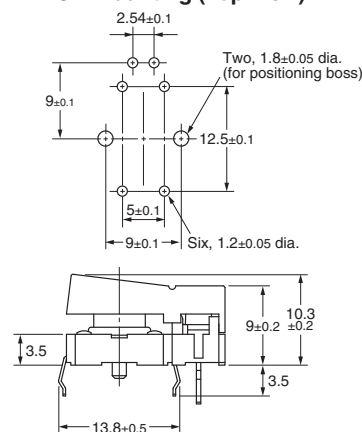

Panel Cutout

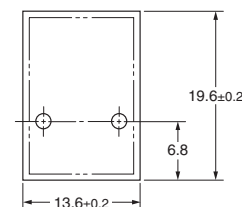

Terminal Arrangement / Internal Connections (Top View)

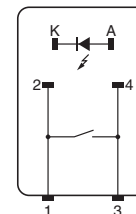

2 LED Types

B3J-5□00
B3J-6□00
B3J-7□00

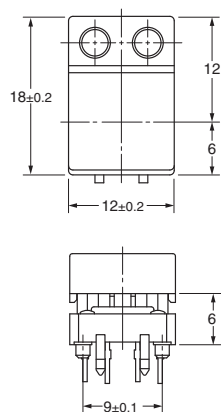
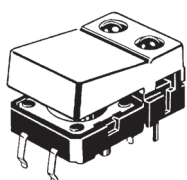

PCB Mounting (Top View)

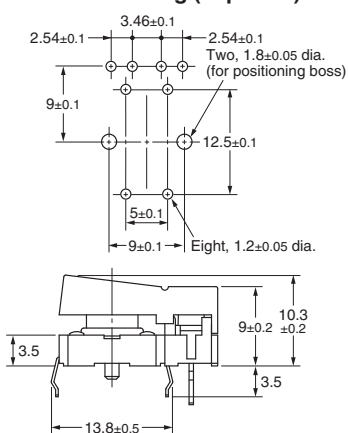

Panel Cutout

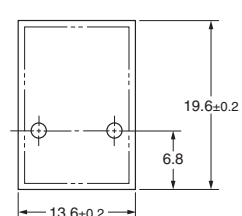

Terminal Arrangement / Internal Connections (Top View)

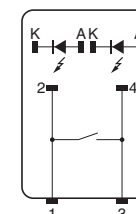

Precautions

Be sure to read the precautions common to all Tactile Switches, contained in the Technical User's Guide, "Tactile Switches, Technical Information" for correct use.

All sales are subject to Omron Electronic Components LLC standard terms and conditions of sale, which can be found at http://www.components.omron.com/components/web/webfiles.nsf/sales_terms.html

ALL DIMENSIONS SHOWN ARE IN MILLIMETERS.

To convert millimeters into inches, multiply by 0.03937. To convert grams into ounces, multiply by 0.03527.

OMRON[®]

**OMRON ELECTRONIC
COMPONENTS LLC**

55 E. Commerce Drive, Suite B
Schaumburg, IL 60173

847-882-2288

OMRON ON-LINE

Global - <http://www.omron.com>

USA - <http://www.components.omron.com>