

## Notice for TAIYO YUDEN products

---

Please read this notice before using the TAIYO YUDEN products.

### REMINDERS

- Product information in this catalog is as of October 2016. All of the contents specified herein are subject to change without notice due to technical improvements, etc. Therefore, please check for the latest information carefully before practical application or use of our products.

Please note that TAIYO YUDEN shall not be in any way responsible for any damages and defects in products or equipment incorporating our products, which are caused under the conditions other than those specified in this catalog or individual specification.

- Please contact TAIYO YUDEN for further details of product specifications as the individual specification is available.
- Please conduct validation and verification of our products in actual condition of mounting and operating environment before using our products.

- The products listed in this catalog are intended for use in general electronic equipment (e.g., AV equipment, OA equipment, home electric appliances, office equipment, information and communication equipment including, without limitation, mobile phone, and PC). Please be sure to contact TAIYO YUDEN for further information before using the products for any equipment which may directly cause loss of human life or bodily injury (e.g., transportation equipment including, without limitation, automotive powertrain control system, train control system, and ship control system, traffic signal equipment, disaster prevention equipment, medical equipment, highly public information network equipment including, without limitation, telephone exchange, and base station).

Please do not incorporate our products into any equipment requiring high levels of safety and/or reliability (e.g., aerospace equipment, aviation equipment, nuclear control equipment, undersea equipment, military equipment).

When our products are used even for high safety and/or reliability-required devices or circuits of general electronic equipment, it is strongly recommended to perform a thorough safety evaluation prior to use of our products and to install a protection circuit as necessary.

Please note that unless you obtain prior written consent of TAIYO YUDEN, TAIYO YUDEN shall not be in any way responsible for any damages incurred by you or third parties arising from use of the products listed in this catalog for any equipment requiring inquiry to TAIYO YUDEN or prohibited for use by TAIYO YUDEN as described above.

- Please note that TAIYO YUDEN shall have no responsibility for any controversies or disputes that may occur in connection with a third party's intellectual property rights and other related rights arising from use of our products. TAIYO YUDEN grants no license for such rights.
- Please note that unless otherwise agreed in writing, the scope of warranty for our products is limited to the delivered our products themselves and TAIYO YUDEN shall not be in any way responsible for any damages resulting from a fault or defect in our products.
- The contents of this catalog are applicable to our products which are purchased from our sales offices or authorized distributors (hereinafter "TAIYO YUDEN's official sales channel"). Please note that the contents of this catalog are not applicable to our products purchased from any seller other than TAIYO YUDEN's official sales channel.

#### ■ Caution for Export

Some of our products listed in this catalog may require specific procedures for export according to "U.S. Export Administration Regulations", "Foreign Exchange and Foreign Trade Control Law" of Japan, and other applicable regulations. Should you have any questions on this matter, please contact our sales staff.

# WIRE-WOUND CHIP POWER INDUCTORS(BR SERIES)



REFLOW

■ PARTS NUMBER

\* Operating Temp.: -40~+105°C(Including self-generated heat)

B	R	△	L	2	5	1	8	T	2	R	2	M	△	△	△
①	②	③	④	⑤	⑥	⑦									

△=Blank space

①Series name

Code	Series name
BR	Wire-Wound chip power inductor

④Packaging

Code	Packaging
T	Taping

②Characteristics

Code	Characteristics
FL	Low profile
△L	
HL	
△C	High current

⑤Nominal inductance

Code (example)	Nominal inductance [μH]
R20	0.2
1R0	1.0
100	10
101	100

※R=Decimal point

③Dimensions (L × W)

Code	Type (inch)	Dimensions (L × W) [mm]
1608	1608(0603)	1.6 × 0.8
2012	2012(0805)	2.0 × 1.25
2016	2016(0806)	2.0 × 1.6
2518	2518(1007)	2.5 × 1.8
3225	3225(1210)	3.2 × 2.5

⑥Inductance tolerance

Code	Inductance tolerance
K	±10%
M	±20%

⑦Internal code

■ STANDARD EXTERNAL DIMENSIONS / STANDARD QUANTITY

Recommended Land Patterns

Surface Mounting

•Mounting and soldering conditions should be checked beforehand.

•Applicable soldering process to these products is reflow soldering only.

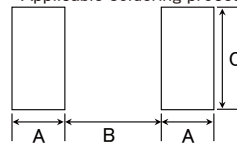
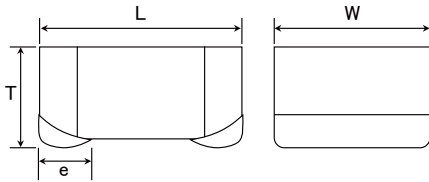

Type	A	B	C
1608	0.55	0.70	1.00
2012	0.60	1.00	1.45
2016	0.60	1.00	1.80
2518	0.60	1.50	2.00
3225	0.85	1.70	2.70

Unit: mm

Type	L	W	T	e	Standard quantity [pcs]	
					Paper tape	Embossed tape
BR L1608	1.6±0.2 (0.063±0.008)	0.8±0.2 (0.031±0.008)	0.7 max (0.028 max)	0.45±0.15 (0.016±0.006)	—	3000
BR C1608	1.6±0.2 (0.063±0.008)	0.8±0.2 (0.031±0.008)	0.8±0.2 (0.031±0.008)	0.45±0.15 (0.016±0.006)	—	3000
BR L2012	2.0±0.2 (0.079±0.008)	1.25±0.2 (0.049±0.008)	1.0 max (0.040 max)	0.5±0.2 (0.020±0.008)	—	3000
BR C2012	2.0±0.2 (0.079±0.008)	1.25±0.2 (0.049±0.008)	1.4 max (0.056 max)	0.5±0.2 (0.020±0.008)	—	2000
BR C2016	2.0±0.2 (0.079±0.008)	1.6±0.2 (0.063±0.008)	1.6±0.2 (0.063±0.008)	0.5±0.2 (0.020±0.008)	—	2000
BRFL2518	2.5±0.2 (0.098±0.008)	1.8±0.2 (0.071±0.008)	1.0 max (0.040 max)	0.5±0.2 (0.020±0.008)	—	3000
BR L2518	2.5±0.2 (0.098±0.008)	1.8±0.2 (0.071±0.008)	1.2 max (0.048 max)	0.5±0.2 (0.020±0.008)	—	3000
BRHL2518	2.5±0.2 (0.098±0.008)	1.8±0.2 (0.071±0.008)	1.5 max (0.060 max)	0.5±0.2 (0.020±0.008)	—	2000
BR C2518	2.5±0.2 (0.098±0.008)	1.8±0.2 (0.071±0.008)	1.8±0.2 (0.071±0.008)	0.5±0.2 (0.020±0.008)	—	2000
BR L3225	3.2±0.2 (0.126±0.008)	2.5±0.2 (0.098±0.008)	1.7 max (0.068 max)	0.75±0.2 (0.03±0.008)	—	2000

Unit: mm (inch)

▶ This catalog contains the typical specification only due to the limitation of space. When you consider the purchase of our products, please check our specification. For details of each product (characteristics graph, reliability information, precautions for use, and so on), see our website (<http://www.ty-top.com/>).

## ● 1608 (0603) TYPE

Parts number	EHS	Nominal inductance [ $\mu$ H]	Inductance tolerance	Self-resonant frequency [MHz] (min.)	DC Resistance [ $\Omega$ ] ( $\pm 30\%$ )	Rated current ※) [mA]		Measuring frequency [MHz]
						Saturation current Idc1	Temperature rise current Idc2	
BR L1608T1R0M	RoHS	1.0	$\pm 20\%$	700	0.230	510	650	1.0
BR L1608T1R5M	RoHS	1.5	$\pm 20\%$	600	0.280	440	590	1.0
BR L1608T2R2M	RoHS	2.2	$\pm 20\%$	400	0.400	360	500	1.0
BR L1608T3R3M	RoHS	3.3	$\pm 20\%$	300	0.650	290	390	1.0
BR L1608T4R7M	RoHS	4.7	$\pm 20\%$	150	1.00	240	310	1.0
BR L1608T6R8M	RoHS	6.8	$\pm 20\%$	100	1.64	200	250	1.0
BR L1608T100M	RoHS	10	$\pm 20\%$	45	2.00	170	220	1.0
BR L1608T150M	RoHS	15	$\pm 20\%$	32	2.56	150	200	1.0

Parts number	EHS	Nominal inductance [ $\mu$ H]	Inductance tolerance	Self-resonant frequency [MHz] (min.)	DC Resistance [ $\Omega$ ] ( $\pm 30\%$ )	Rated current ※) [mA]		Measuring frequency [MHz]
						Saturation current Idc1	Temperature rise current Idc2	
BR C1608TR43M 6	RoHS	0.43	$\pm 20\%$	740	0.082	1,400	1,100	6.0
BR C1608TR50M 6	RoHS	0.50	$\pm 20\%$	710	0.090	1,200	1,050	6.0
BR C1608TR60M 6	RoHS	0.60	$\pm 20\%$	630	0.099	1,100	940	6.0
BR C1608TR72M 6	RoHS	0.72	$\pm 20\%$	600	0.144	1,000	810	6.0
BR C1608TR82M 6	RoHS	0.82	$\pm 20\%$	560	0.176	950	730	6.0
BR C1608T1R0M 6	RoHS	1.0	$\pm 20\%$	550	0.188	890	680	6.0

Parts number	EHS	Nominal inductance [ $\mu$ H]	Inductance tolerance	Self-resonant frequency [MHz] (min.)	DC Resistance [ $\Omega$ ] ( $\pm 30\%$ )	Rated current ※) [mA]		Measuring frequency [MHz]
						Saturation current Idc1	Temperature rise current Idc2	
BR C1608TR20M	RoHS	0.20	$\pm 20\%$	400	0.060	1,750	980	7.96
BR C1608TR35M	RoHS	0.35	$\pm 20\%$	300	0.080	1,400	810	7.96
BR C1608TR45M	RoHS	0.45	$\pm 20\%$	200	0.090	1,250	800	7.96
BR C1608TR56M	RoHS	0.56	$\pm 20\%$	170	0.095	1,150	760	7.96
BR C1608TR77M	RoHS	0.77	$\pm 20\%$	150	0.110	1,000	660	7.96
BR C1608T1R0M	RoHS	1.0	$\pm 20\%$	140	0.180	850	520	7.96
BR C1608T1R5M	RoHS	1.5	$\pm 20\%$	120	0.300	700	410	7.96
BR C1608T2R2M	RoHS	2.2	$\pm 20\%$	100	0.550	550	280	7.96

## ● 2012 (0805) TYPE

Parts number	EHS	Nominal inductance [ $\mu$ H]	Inductance tolerance	Self-resonant frequency [MHz] (min.)	DC Resistance [ $\Omega$ ] ( $\pm 30\%$ )	Rated current ※) [mA]		Measuring frequency [MHz]
						Saturation current Idc1	Temperature rise current Idc2	
BR L2012TR47M 6	RoHS	0.47	$\pm 20\%$	500	0.048	1,500	1,900	6.0
BR L2012T1R0M 6	RoHS	1.0	$\pm 20\%$	400	0.108	1,050	1,230	6.0
BR L2012T2R2MD6	RoHS	2.2	$\pm 20\%$	250	0.184	680	950	6.0

Parts number	EHS	Nominal inductance [ $\mu$ H]	Inductance tolerance	Self-resonant frequency [MHz] (min.)	DC Resistance [ $\Omega$ ] ( $\pm 30\%$ )	Rated current ※) [mA]		Measuring frequency [MHz]
						Saturation current Idc1	Temperature rise current Idc2	
BR L2012TR47M	RoHS	0.47	$\pm 20\%$	350	0.090	1,100	1,050	7.96
BR L2012T1R0M	RoHS	1.0	$\pm 20\%$	300	0.135	850	850	7.96
BR L2012T1R5M	RoHS	1.5	$\pm 20\%$	250	0.180	700	750	7.96
BR L2012T2R2M	RoHS	2.2	$\pm 20\%$	200	0.300	600	550	7.96
BR L2012T3R3M	RoHS	3.3	$\pm 20\%$	190	0.500	490	440	7.96
BR L2012T4R7M	RoHS	4.7	$\pm 20\%$	150	0.550	340	400	7.96
BR L2012T6R8M	RoHS	6.8	$\pm 20\%$	60	0.750	290	350	7.96
BR L2012T100M	RoHS	10	$\pm 20\%$	30	0.850	270	330	2.52
BR L2012T150M	RoHS	15	$\pm 20\%$	15	1.00	220	300	2.52
BR L2012T220M	RoHS	22	$\pm 20\%$	13	1.30	190	270	2.52
BR L2012T330M	RoHS	33	$\pm 20\%$	8.0	2.00	150	220	2.52
BR L2012T470M	RoHS	47	$\pm 20\%$	7.0	3.50	125	160	2.52
BR L2012T680M	RoHS	68	$\pm 20\%$	6.5	5.80	100	110	2.52
BR L2012T101M	RoHS	100	$\pm 20\%$	6.0	7.70	85	85	0.796

Parts number	EHS	Nominal inductance [ $\mu$ H]	Inductance tolerance	Self-resonant frequency [MHz] (min.)	DC Resistance [ $\Omega$ ] ( $\pm 30\%$ )	Rated current ※) [mA]		Measuring frequency [MHz]
						Saturation current Idc1	Temperature rise current Idc2	
BR C2012T1R0M	RoHS	1.0	$\pm 20\%$	490	0.060	1,500	1,400	1.0
BR C2012T1R5MD	RoHS	1.5	$\pm 20\%$	390	0.090	1,200	1,100	1.0
BR C2012T2R2MD	RoHS	2.2	$\pm 20\%$	350	0.110	1,100	1,000	1.0
BR C2012T3R3MD	RoHS	3.3	$\pm 20\%$	300	0.170	800	870	1.0
BR C2012T4R7MD	RoHS	4.7	$\pm 20\%$	250	0.265	700	600	1.0

※) The saturation current value (Idc1) is the DC current value having inductance decrease down to 30%. (at 20°C)

※) The temperature rise current value (Idc2) is the DC current value having temperature increase by 40°C. (at 20°C)

※) The rated current value is following either Idc1 or Idc2, which is the lower one.

## 2016 (0806) TYPE

Parts number	EHS	Nominal inductance [ $\mu$ H]	Inductance tolerance	Self-resonant frequency [MHz] (min.)	DC Resistance [ $\Omega$ ] ( $\pm 30\%$ )	Rated current ※) [mA]		Measuring frequency [MHz]
						Saturation current Idc1	Temperature rise current Idc2	
BR C2016T1R0M	RoHS	1.0	$\pm 20\%$	450	0.085	1,350	1,100	0.10
BR C2016T1R5M	RoHS	1.5	$\pm 20\%$	370	0.150	1,100	820	0.10
BR C2016T2R2M	RoHS	2.2	$\pm 20\%$	250	0.180	910	760	0.10
BR C2016T3R3M	RoHS	3.3	$\pm 20\%$	140	0.220	740	680	0.10
BR C2016T4R7M	RoHS	4.7	$\pm 20\%$	78	0.270	660	610	0.10
BR C2016T6R8M	RoHS	6.8	$\pm 20\%$	39	0.330	550	560	0.10
BR C2016T100□	RoHS	10	$\pm 10\%, \pm 20\%$	35	0.400	450	520	0.10
BR C2016T150□	RoHS	15	$\pm 10\%, \pm 20\%$	28	0.600	400	410	0.10
BR C2016T220□	RoHS	22	$\pm 10\%, \pm 20\%$	24	1.00	310	310	0.10
BR C2016T330□	RoHS	33	$\pm 10\%, \pm 20\%$	13	1.70	270	240	0.10
BR C2016T470□	RoHS	47	$\pm 10\%, \pm 20\%$	11	2.20	210	210	0.10
BR C2016T680□	RoHS	68	$\pm 10\%, \pm 20\%$	8	2.80	200	190	0.10
BR C2016T101□	RoHS	100	$\pm 10\%, \pm 20\%$	7	3.40	140	170	0.10

## 2518 (1007) TYPE

Parts number	EHS	Nominal inductance [ $\mu$ H]	Inductance tolerance	Self-resonant frequency [MHz] (min.)	DC Resistance [ $\Omega$ ] ( $\pm 30\%$ )	Rated current ※) [mA]		Measuring frequency [MHz]
						Saturation current Idc1	Temperature rise current Idc2	
BRFL2518T1R0M	RoHS	1.0	$\pm 20\%$	130	0.090	1,200	1,200	1.0
BRFL2518T1R5M	RoHS	1.5	$\pm 20\%$	100	0.110	1,100	1,000	1.0
BRFL2518T2R2M	RoHS	2.2	$\pm 20\%$	80	0.130	850	950	1.0
BRFL2518T3R3M	RoHS	3.3	$\pm 20\%$	70	0.220	700	700	1.0
BRFL2518T4R7M	RoHS	4.7	$\pm 20\%$	60	0.330	650	650	1.0

Parts number	EHS	Nominal inductance [ $\mu$ H]	Inductance tolerance	Self-resonant frequency [MHz] (min.)	DC Resistance [ $\Omega$ ] ( $\pm 30\%$ )	Rated current ※) [mA]		Measuring frequency [MHz]
						Saturation current Idc1	Temperature rise current Idc2	
BR L2518T1R0M	RoHS	1.0	$\pm 20\%$	130	0.080	1,600	1,000	7.96
BR L2518T1R5M	RoHS	1.5	$\pm 20\%$	100	0.100	1,200	920	7.96
BR L2518T2R2M	RoHS	2.2	$\pm 20\%$	80	0.135	1,000	850	7.96
BR L2518T3R3M	RoHS	3.3	$\pm 20\%$	70	0.300	800	580	7.96
BR L2518T4R7M	RoHS	4.7	$\pm 20\%$	60	0.400	700	470	7.96

Parts number	EHS	Nominal inductance [ $\mu$ H]	Inductance tolerance	Self-resonant frequency [MHz] (min.)	DC Resistance [ $\Omega$ ] ( $\pm 30\%$ )	Rated current ※) [mA]		Measuring frequency [MHz]
						Saturation current Idc1	Temperature rise current Idc2	
BRHL2518T1R0M	RoHS	1.0	$\pm 20\%$	400	0.055	2,000	1,400	1.0
BRHL2518T1R5M	RoHS	1.5	$\pm 20\%$	350	0.085	1,700	1,100	1.0
BRHL2518T2R2M	RoHS	2.2	$\pm 20\%$	300	0.115	1,500	1,000	1.0
BRHL2518T3R3MD	RoHS	3.3	$\pm 20\%$	200	0.165	1,200	800	1.0
BRHL2518T4R7MD	RoHS	4.7	$\pm 20\%$	150	0.245	1,100	750	1.0

Parts number	EHS	Nominal inductance [ $\mu$ H]	Inductance tolerance	Self-resonant frequency [MHz] (min.)	DC Resistance [ $\Omega$ ] ( $\pm 30\%$ )	Rated current ※) [mA]		Measuring frequency [MHz]
						Saturation current Idc1	Temperature rise current Idc2	
BR C2518T1R0M	RoHS	1.0	$\pm 20\%$	280	0.050	2,550	1,650	1.0
BR C2518T1R5M	RoHS	1.5	$\pm 20\%$	230	0.080	2,100	1,300	1.0
BR C2518T2R2M	RoHS	2.2	$\pm 20\%$	200	0.120	1,800	1,000	1.0
BR C2518T3R3M	RoHS	3.3	$\pm 20\%$	150	0.175	1,450	860	1.0
BR C2518T4R7M	RoHS	4.7	$\pm 20\%$	100	0.230	1,250	750	1.0
BR C2518T6R8M	RoHS	6.8	$\pm 20\%$	45	0.280	1,050	680	1.0
BR C2518T100□	RoHS	10	$\pm 10\%, \pm 20\%$	20	0.350	890	610	1.0
BR C2518T150□	RoHS	15	$\pm 10\%, \pm 20\%$	13	0.430	760	550	1.0
BR C2518T220□	RoHS	22	$\pm 10\%, \pm 20\%$	10	0.560	640	490	1.0
BR C2518T330□	RoHS	33	$\pm 10\%, \pm 20\%$	8	0.850	560	390	1.0
BR C2518T470□	RoHS	47	$\pm 10\%, \pm 20\%$	6.5	1.45	410	300	1.0
BR C2518T680□	RoHS	68	$\pm 10\%, \pm 20\%$	5.5	2.40	340	230	1.0
BR C2518T101□	RoHS	100	$\pm 10\%, \pm 20\%$	4.5	3.60	300	190	1.0

□ Please specify the inductance tolerance code. (M or K)

※) The saturation current value (Idc1) is the DC current value having inductance decrease down to 30%. (at 20°C)

※) The temperature rise current value (Idc2) is the DC current value having temperature increase by 40°C. (at 20°C)

※) The rated current value is following either Idc1 or Idc2, which is the lower one.

■ PARTS NUMBER

● 3225 (1210) TYPE

Parts number	EHS	Nominal inductance [ $\mu$ H]	Inductance tolerance	Self-resonant frequency [MHz] (min.)	DC Resistance [ $\Omega$ ] ( $\pm$ 30%)	Rated current ※) [mA]		Measuring frequency [MHz]
						Saturation current Idc1	Temperature rise current Idc2	
BR L3225TR27M	RoHS	0.27	$\pm$ 20%	390	0.022	4,500	2,850	7.96
BR L3225TR36M	RoHS	0.36	$\pm$ 20%	350	0.025	4,300	2,750	7.96
BR L3225TR51M	RoHS	0.51	$\pm$ 20%	270	0.029	3,600	2,550	7.96

Parts number	EHS	Nominal inductance [ $\mu$ H]	Inductance tolerance	Self-resonant frequency [MHz] (min.)	DC Resistance [ $\Omega$ ] ( $\pm$ 20%)	Rated current ※) [mA]		Measuring frequency [MHz]
						Saturation current Idc1	Temperature rise current Idc2	
BR L3225T1R0M	RoHS	1.0	$\pm$ 20%	220	0.043	2,400	2,200	0.1
BR L3225T1R5M	RoHS	1.5	$\pm$ 20%	170	0.045	2,200	1,750	0.1
BR L3225T2R2M	RoHS	2.2	$\pm$ 20%	150	0.065	1,850	1,600	0.1
BR L3225T3R3M	RoHS	3.3	$\pm$ 20%	140	0.120	1,450	1,200	0.1
BR L3225T4R7M	RoHS	4.7	$\pm$ 20%	120	0.180	1,300	1,000	0.1
BR L3225T6R8M	RoHS	6.8	$\pm$ 20%	90	0.270	1,050	770	0.1
BR L3225T100□	RoHS	10	$\pm$ 10%, $\pm$ 20%	70	0.350	900	700	0.1
BR L3225T150□	RoHS	15	$\pm$ 10%, $\pm$ 20%	20	0.570	700	530	0.1
BR L3225T220□	RoHS	22	$\pm$ 10%, $\pm$ 20%	13	0.690	550	470	0.1
BR L3225T330□	RoHS	33	$\pm$ 10%, $\pm$ 20%	9	0.840	470	420	0.1
BR L3225T470□	RoHS	47	$\pm$ 10%, $\pm$ 20%	7	1.00	420	390	0.1
BR L3225T680□	RoHS	68	$\pm$ 10%, $\pm$ 20%	6	1.40	330	300	0.1
BR L3225T101□	RoHS	100	$\pm$ 10%, $\pm$ 20%	5	2.50	270	250	0.1

□ Please specify the inductance tolerance code. (M or K)

※) The saturation current value (Idc1) is the DC current value having inductance decrease down to 30%. (at 20°C)

※) The temperature rise current value (Idc2) is the DC current value having temperature increase by 40°C. (at 20°C)

※) The rated current value is following either Idc1 or Idc2, which is the lower one.

# WIRE-WOUND CHIP POWER INDUCTORS (BR SERIES)

## PACKAGING

### ① Minimum Quantity

Type	Standard Quantity [pcs]	
	Paper Tape	Embossed Tape
BR C1608	—	3,000
BR L1608	—	3,000
BR L2012	—	3,000
BR C2012	—	2,000
BR C2016	—	2,000
BR C2518	—	2,000
BRHL2518	—	2,000
BR L2518	—	3,000
BRFL2518	—	3,000
BR L3225	—	2,000

### ② Tape Material

#### ● Embossed tape

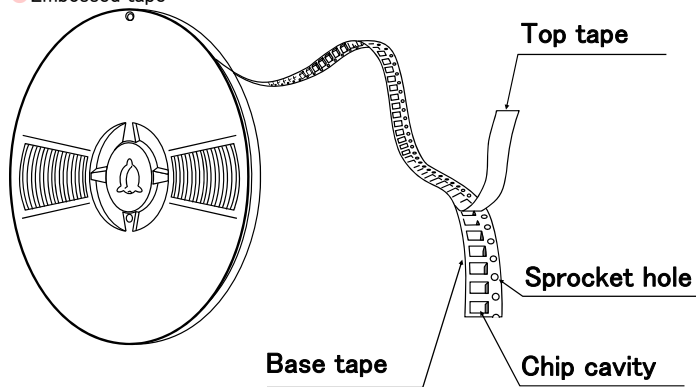

#### Chip Filled

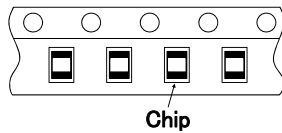

### ③ Taping dimensions

#### ● Embossed Tape 8mm wide (0.315 inches wide)

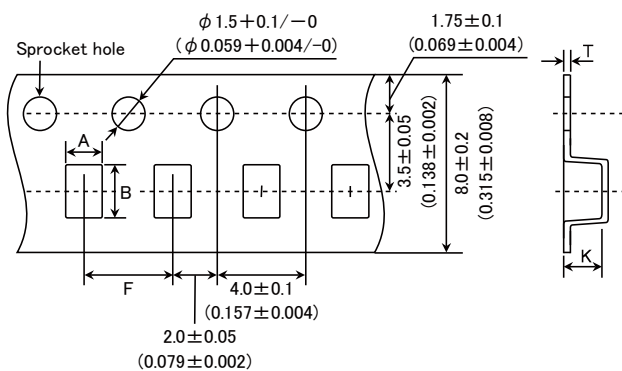

▶ This catalog contains the typical specification only due to the limitation of space. When you consider the purchase of our products, please check our specification. For details of each product (characteristics graph, reliability information, precautions for use, and so on), see our Web site (<http://www.ty-top.com/>).

Type	Chip cavity		Insertion pitch	Tape thickness	
	A	B	F	T	K
BR L1608	1.1±0.1 (0.043±0.004)	1.9±0.1 (0.075±0.004)	4.0±0.1 (0.157±0.004)	0.2±0.05 (0.008±0.002)	0.9 max (0.035 max)
BR C1608	1.1±0.1 (0.043±0.004)	1.9±0.1 (0.075±0.004)	4.0±0.1 (0.157±0.004)	0.25±0.05 (0.010±0.002)	1.2 max (0.047 max)
BR L2012	1.45±0.1 (0.057±0.004)	2.2±0.1 (0.087±0.004)	4.0±0.1 (0.157±0.004)	0.25±0.05 (0.010±0.002)	1.2 max (0.047 max)
BR C2012	1.45±0.1 (0.057±0.004)	2.37±0.1 (0.093±0.004)	4.0±0.1 (0.157±0.004)	0.25±0.05 (0.010±0.002)	1.59 max (0.063 max)
BR C2016	1.75±0.1 (0.069±0.004)	2.1±0.1 (0.083±0.004)	4.0±0.1 (0.157±0.004)	0.3±0.05 (0.012±0.002)	1.9 max (0.075 max)
BRFL2518	2.3±0.1 (0.091±0.004)	2.8±0.1 (0.110±0.004)	4.0±0.1 (0.157±0.004)	0.25±0.05 (0.010±0.002)	1.3 max (0.051 max)
BR L2518	2.3±0.1 (0.091±0.004)	2.8±0.1 (0.110±0.004)	4.0±0.1 (0.157±0.004)	0.3±0.05 (0.012±0.002)	1.45 max (0.057 max)
BRHL2518	2.1±0.1 (0.083±0.004)	2.8±0.1 (0.110±0.004)	4.0±0.1 (0.157±0.004)	0.3±0.05 (0.012±0.002)	1.7 max (0.067 max)
BR C2518	2.15±0.1 (0.085±0.004)	2.7±0.1 (0.106±0.004)	4.0±0.1 (0.157±0.004)	0.3±0.05 (0.012±0.002)	2.2 max (0.087 max)
BR L3225	2.8±0.1 (0.110±0.004)	3.5±0.1 (0.138±0.004)	4.0±0.1 (0.157±0.004)	0.25±0.05 (0.010±0.002)	1.9 max (0.075 max)

Unit: mm (inch)

#### ④ Leader and Blank portion

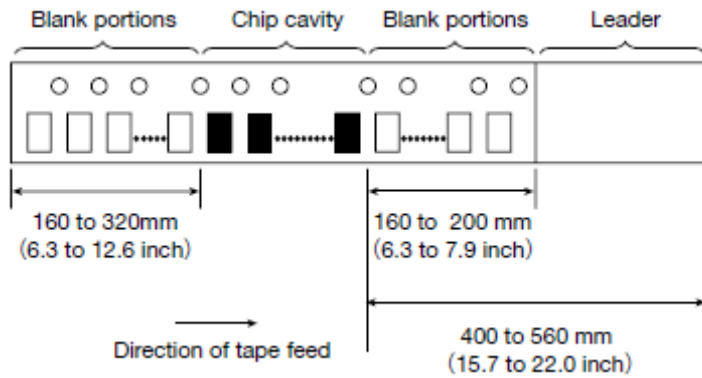

#### ⑤ Reel size

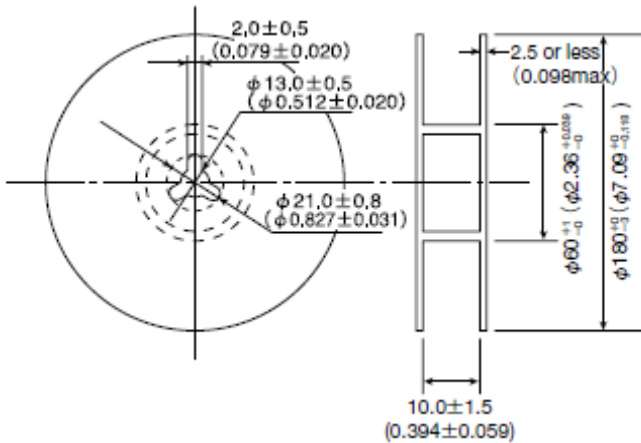

#### ⑥ Top Tape Strength

The top tape requires a peel-off force of 0.2 to 0.7N in the direction of the arrow as illustrated below.

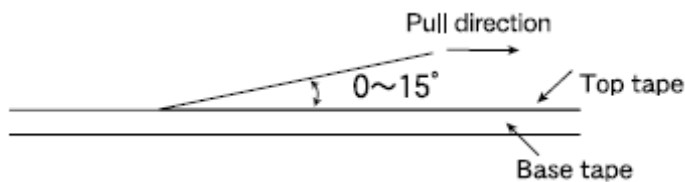

# WIRE-WOUND CHIP POWER INDUCTORS (BR SERIES)

## RELIABILITY DATA

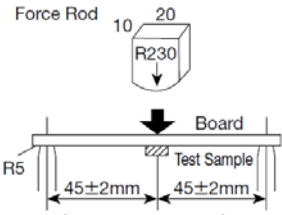
1. Operating Temperature Range		
Specified Value	BR series	-40~+105°C
Test Methods and Remarks	Including self-generated heat	
2. Storage Temperature Range (after soldering)		
Specified Value	BR series	-40~+85°C
Test Methods and Remarks	Please refer the term of "7.Storage conditions" in Precautions.	
3. Rated current		
Specified Value	BR series	Within the specified tolerance
4. Inductance		
Specified Value	BR series	Within the specified tolerance
Test Methods and Remarks	Measuring equipment : LCR Meter (HP 4285A or equivalent) Measuring frequency : Specified frequency	
5. DC Resistance		
Specified Value	BR series	Within the specified tolerance
Test Methods and Remarks	Measuring equipment : DC ohmmeter (HIOKI 3227 or equivalent)	
6. Self resonance frequency		
Specified Value	BR series	Within the specified tolerance
Test Methods and Remarks	Measuring equipment : Impedance analyzer/material analyzer (HP4291A or equivalent HP4191A, 4192A or equivalent)	
7. Temperature characteristic		
Specified Value	BR series	Inductance change : Within $\pm 15\%$
Test Methods and Remarks	Based on the inductance at 20°C and Measured at the ambient of -40°C~+85°C.	
8. Resistance to the bendability		
Specified Value	BR series	No damage.
Test Methods and Remarks	The given sample is soldered on the board and then the back side of the board is pushed until it bends 2mm like the figure. Dimension of the board : 100×40×1.0mm (0.8mm thickness for 1608(0603) inductors) Material of the board : Glass epoxy-resin Thickness of soldering paste : 0.12mm 	

▶ This catalog contains the typical specification only due to the limitation of space. When you consider the purchase of our products, please check our specification. For details of each product (characteristics graph, reliability information, precautions for use, and so on), see our Web site (<http://www.ty-top.com/>).

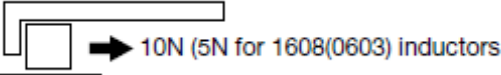

9. Body strength		
Specified Value	BR series	No damage.
Test Methods and Remarks	2012~ Applied orce : 10N Duration : 10sec. 1608 size Applied force : 5N Duration : 10sec.	

10. Adhesion of terminal electrodes		
Specified Value	BR series	Not to removed from the board.
Test Methods and Remarks	The given sample is soldered to the board and then it is kept for 5sec with 10N stress (5N for 1608(0603) inductors) like the figure. 	

11. Resistance to vibration																
Specified Value	BR series	Inductance change : Within $\pm 10\%$ No significant abnormality in appearance.														
Test Methods and Remarks	The given sample is soldered to the board and then it is tested depending on the conditions of the following table. <table border="1" data-bbox="280 730 1155 904"> <tr> <td>Vibration Frequency</td> <td colspan="2">10~55Hz</td> </tr> <tr> <td>Total Amplitude</td> <td colspan="2">1.5mm (May not exceed acceleration 196m/s<sup>2</sup>)</td> </tr> <tr> <td>Sweeping Method</td> <td colspan="2">10Hz to 55Hz to 10Hz for 1min.</td> </tr> <tr> <td rowspan="3">Time</td> <td>X</td> <td rowspan="3">For 2 hours on each X, Y, and Z axis.</td> </tr> <tr> <td>Y</td> </tr> <tr> <td>Z</td> </tr> </table> Recovery : At least 2hrs of recovery under the standard condition after the test, followed by the measurement within 48hrs.		Vibration Frequency	10~55Hz		Total Amplitude	1.5mm (May not exceed acceleration 196m/s <sup>2</sup> )		Sweeping Method	10Hz to 55Hz to 10Hz for 1min.		Time	X	For 2 hours on each X, Y, and Z axis.	Y	Z
Vibration Frequency	10~55Hz															
Total Amplitude	1.5mm (May not exceed acceleration 196m/s <sup>2</sup> )															
Sweeping Method	10Hz to 55Hz to 10Hz for 1min.															
Time	X	For 2 hours on each X, Y, and Z axis.														
	Y															
	Z															

12. Solderability						
Specified Value	BR series	At least 90% area of the electrodes is covered by new solder.				
Test Methods and Remarks	Test Method and Remarks】 The given sample is dipped into the flux and then it is tested depending on the conditions of the following table. Flux : Methanol solution containing rosin 25%. <table border="1" data-bbox="280 1133 699 1193"> <tr> <td>Solder Temperature</td> <td>245<math>\pm</math>5<math>^{\circ}</math>C</td> </tr> <tr> <td>Time</td> <td>5<math>\pm</math>0.5 sec.</td> </tr> </table>		Solder Temperature	245 $\pm$ 5 $^{\circ}$ C	Time	5 $\pm$ 0.5 sec.
Solder Temperature	245 $\pm$ 5 $^{\circ}$ C					
Time	5 $\pm$ 0.5 sec.					

13. Resistance to soldering heat		
Specified Value	BR series	Inductance change : Within $\pm 10\%$ No significant abnormality in appearance.
Test Methods and Remarks	3 times reflow having the temperature profile of 5sec of 260 $\pm$ 0/ $-$ 5 $^{\circ}$ C and 40sec of more than 230 $^{\circ}$ C. Test board thickness : 1.0mm Test board material : Glass epoxy-resin Recovery : At least 2hrs of recovery under the standard condition after the test, followed by the measurement within 48hrs.	

14. Thermal shock																				
Specified Value	BR series	Inductance change : Within $\pm 10\%$ No significant abnormality in appearance.																		
Test Methods and Remarks	The given sample is soldered to the board and then its Inductance is measured after 100cycles of the following conditions. <table border="1" data-bbox="280 1630 890 1805"> <thead> <tr> <th colspan="3">Conditions of 1 cycle</th> </tr> <tr> <th>Step</th> <th>Temperature (<math>^{\circ}</math>C)</th> <th>Duration (min)</th> </tr> </thead> <tbody> <tr> <td>1</td> <td>-40<math>\pm</math>3</td> <td>30<math>\pm</math>3</td> </tr> <tr> <td>2</td> <td>Room temperature</td> <td>Within 3</td> </tr> <tr> <td>3</td> <td>+85<math>\pm</math>2</td> <td>30<math>\pm</math>3</td> </tr> <tr> <td>4</td> <td>Room temperature</td> <td>Within 3</td> </tr> </tbody> </table> Recovery : At least 2hrs of recovery under the standard condition after the test, followed by the measurement within 48 hrs.		Conditions of 1 cycle			Step	Temperature ( $^{\circ}$ C)	Duration (min)	1	-40 $\pm$ 3	30 $\pm$ 3	2	Room temperature	Within 3	3	+85 $\pm$ 2	30 $\pm$ 3	4	Room temperature	Within 3
Conditions of 1 cycle																				
Step	Temperature ( $^{\circ}$ C)	Duration (min)																		
1	-40 $\pm$ 3	30 $\pm$ 3																		
2	Room temperature	Within 3																		
3	+85 $\pm$ 2	30 $\pm$ 3																		
4	Room temperature	Within 3																		

▶ This catalog contains the typical specification only due to the limitation of space. When you consider the purchase of our products, please check our specification. For details of each product (characteristics graph, reliability information, precautions for use, and so on), see our Web site (<http://www.ty-top.com/>).

15. Damp heat		
Specified Value	BR series	Inductance change : Within $\pm 10\%$ No significant abnormality in appearance.
Test Methods and Remarks	The given sample is soldered to the board and then it is kept at the following conditions.	
	Temperature	$60 \pm 2^\circ\text{C}$
	Humidity	90~95%RH
	Time	1000 hours.
Recovery : At least 2hrs of recovery under the standard condition after the test, followed by the measurement within 48 hrs.		

16. Loading under damp heat		
Specified Value	BR series	Inductance change : Within $\pm 10\%$ No significant abnormality in appearance.
Test Methods and Remarks	The given sample is soldered to the board and then it is kept at the following conditions.	
	Temperature	$60 \pm 2^\circ\text{C}$
	Humidity	90~95%RH
	Applied current	Rated current
	Time	1000hours.
Recovery : At least 2hrs of recovery under the standard condition after the test, followed by the measurement within 48 hrs.		

17. Low temperature life test		
Specified Value	BR series	Inductance change : Within $\pm 10\%$ No significant abnormality in appearance.
Test Methods and Remarks	The given sample is soldered to the board and then it is kept at the following conditions.	
	Temperature	$-40 \pm 2^\circ\text{C}$
	Duration	1000hours
	Recovery : At least 2hrs of recovery under the standard condition after the test, followed by the measurement within 48 hrs.	

18. High temperature life test		
Specified Value	BR series	Inductance change : Within $\pm 10\%$ No significant abnormality in appearance.
Test Methods and Remarks	The given sample is soldered to the board and then it is kept at the following conditions.	
	Temperature	$85 \pm 2^\circ\text{C}$
	Duration	1000hours
	Recovery : At least 2hrs of recovery under the standard condition after the test, followed by the measurement within 48 hrs.	

19. Standard conditions		
Specified Value	BR series	Standard test condition : Unless otherwise specified, temperature is $20 \pm 15^\circ\text{C}$ and $65 \pm 20\%$ of relative humidity. When there is any question concerning measurement result: In order to provide correlation data, the test shall be condition of $20 \pm 2^\circ\text{C}$ of temperature, $65 \pm 5\%$ relative humidity. Inductance is in accordance with our measured value.

# WIRE-WOUND CHIP POWER INDUCTORS(BR SERIES)

## PRECAUTIONS

1. Circuit Design	
Precautions	<p>◆Operating Ambient The products are premised on the usage for the general equipments like the office supply equipment, the telecommunications systems, the measuring equipment, the household equipment and so on. Please ask to TAIYO YUDEN's sales person in advance, if you need to apply them to the equipments or the systems which might have any influences for the human body, the property, like the traffic systems, the safety equipment, the aerospace systems, the nuclear control systems, the medical equipment and soon.</p>
2. PCB Design	
Precautions	<p>◆Land pattern design 1. Please refer to a recommended land pattern.</p>
Technical considerations	<p>◆Land pattern design Surface Mounting 1. The conditions of the picking and placing should be checked in advance. 2. The products are only for reflow soldering.</p>
3. Considerations for automatic placement	
Precautions	<p>◆Adjustment of mounting machine 1. Excessive physical impact should not be imposed on the products for picking and placing onto the PC boards. 2. Mounting and soldering conditions should be checked in advance.</p>
Technical considerations	<p>◆Adjustment of mounting machine The products might be broken if too much stress is given for the picking and placing.</p>
4. Soldering	
Precautions	<p>◆Reflow soldering 1. Please apply our recommended soldering conditions on the specification as much as possible. 2. The products are only for reflow soldering. 3. Please do not give any stress to a product until it returns in room temperature after reflow soldering. ◆Recommended conditions for using a soldering iron. (Excluding 1608 type) Touch a soldering iron to the land pattern not to the product directly. The temperature of a soldering iron is less than 350degC. The soldering is for 3 seconds or less.</p>
Technical considerations	<p>◆Reflow soldering 1. The product might break or might make the tombstoning, if the soldering conditions are too far from our recommended conditions.</p> <p>Temperature [°C]</p> <p>Heating Time [sec]</p> <p>150~180</p> <p>90±30sec</p> <p>30±10sec</p> <p>230°C min</p> <p>5sec max</p> <p>Peak: 260+0/-5°C</p>
5. Cleaning	
Precautions	<p>◆Cleaning conditions 1. Please don't wash by the ultra-sonic waves.</p>
Technical considerations	<p>◆Cleaning conditions 1. Washing by the ultra-sonic waves might break the product.</p>

6. Handling	
Precautions	<ul style="list-style-type: none"> <li>◆ Handling               <ol style="list-style-type: none"> <li>1. Keep the product away from any magnets.</li> </ol> </li> <li>◆ Cutting the PC boards               <ol style="list-style-type: none"> <li>1. Please don't give any stress of the bending or the twisting for the cutting process of PC boards.</li> <li>2. Please don't give any shock and stress to the products in transportation.</li> </ol> </li> <li>◆ Mechanical considerations               <ol style="list-style-type: none"> <li>1. Please don't give too much shock to the product.</li> <li>2. Please don't give any shock and stress to the products in transportation.</li> </ol> </li> <li>◆ The stress for picking and placing               <ol style="list-style-type: none"> <li>1. Please don't give any shock into an exposed ferrite core.</li> </ol> </li> <li>◆ Packing               <ol style="list-style-type: none"> <li>1. Please don't pile the packing boxes up as much as possible.</li> </ol> </li> </ul>
Technical considerations	<ul style="list-style-type: none"> <li>◆ Handling               <ol style="list-style-type: none"> <li>1. There is a case that a characteristic varies with magnetic influence.</li> </ol> </li> <li>◆ Cutting the PC boards               <ol style="list-style-type: none"> <li>1. Please don't give the bending stress or the twisting stress to the products because they might break in such cases.</li> </ol> </li> <li>◆ Mechanical considerations               <ol style="list-style-type: none"> <li>1. The mechanical shock might break the products.</li> <li>2. The products might break depending on the handling in transportation.</li> </ol> </li> <li>◆ Pick-up pressure               <ol style="list-style-type: none"> <li>1. The electrical characteristics of the products might be shifted by too much physical shock and stress.</li> </ol> </li> <li>◆ Packing               <ol style="list-style-type: none"> <li>1. The products and the tape might break, if the packing boxes are piled up.</li> </ol> </li> </ul>
7. Storage conditions	
Precautions	<ul style="list-style-type: none"> <li>◆ Storage               <ol style="list-style-type: none"> <li>1. The packing boxes can be kept at the ambient which the temperature is from 0 to 40degC and the humidity is less than 70%.</li> <li>2. The ambient temperature of less than 30degC is recommended not to get the tape and the solderability worse.</li> <li>3. Please solder the products by a half year after they have been shipped.</li> </ol>               Otherwise please use them after checking the solderability in advance.             </li> </ul>
Technical considerations	<ul style="list-style-type: none"> <li>◆ Storage               <ol style="list-style-type: none"> <li>1. The ambient of high temperature or high humidity might accelerate to make the solderability and the tape worse.</li> </ol> </li> </ul>