

Description

The AP7344 is a Dual low dropout regulator with high output voltage accuracy, low $R_{DS(ON)}$, high PSRR, low output noise and low quiescent current. This regulator is based on a CMOS process.

Each of regulators includes a voltage reference, error amplifier, current limit circuit and an enable input to turn on/ off output. With the integrated resistor network fixed output voltage versions can be delivered.

With its low power consumption and line and load transient response, the AP7344 is well suited for low power handheld communication equipment.

The AP7344 is packaged in X2-DFN1612-8 package and allows for smallest footprint and dense PCB layout.

Features

- Low V_{IN} and Wide V_{IN} Range: 1.7V to 5.25V
- Guarantee Output Current: 300mA
- V_{OUT} Accuracy $\pm 1\%$
- Ripple Rejection: 75dB at 1kHz
- Low Output Noise: $60\mu V_{rms}$ from 10Hz to 100kHz
- Quiescent Current as Low as 50 μA
- V_{OUT} Fixed 1.2V to 3.6V
- **Totally Lead-Free & Fully RoHS Compliant (Notes 1 & 2)**
- **Halogen and Antimony Free, Green Device (Note 3)**

- Notes:
1. No purposely added lead. Fully EU Directive 2002/95/EC (RoHS) & 2011/65/EU (RoHS 2) compliant.
 2. See http://www.diodes.com/quality/lead_free.html for more information about Diodes Incorporated's definitions of Halogen- and Antimony-free, "Green" and Lead-free.
 3. Halogen- and Antimony-free "Green" products are defined as those which contain <900ppm bromine, <900ppm chlorine (<1500ppm total Br + Cl) and <1000ppm antimony compounds.

Pin Assignments

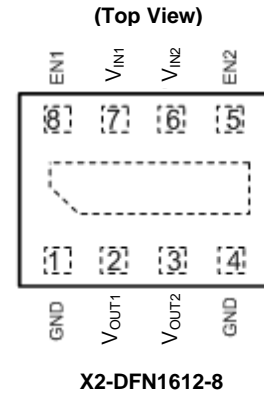

Applications

- Smart Phone/PAD
- RF Supply
- Cameras
- Portable Video
- Portable Media Player
- Wireless Adapter
- Wireless Communication

Typical Applications Circuit

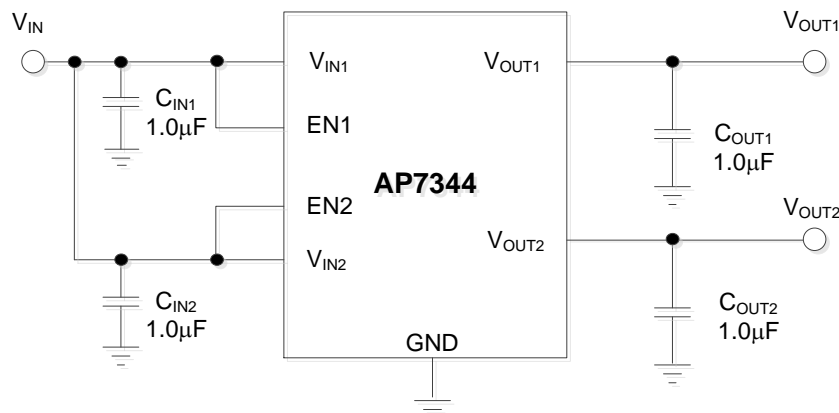

Pin Descriptions

Pin Number	Pin Name	Function
GND	1, 4	Ground
V _{OUT1}	2	Channel 1 Output Voltage pin
V _{OUT2}	3	Channel 2 Output Voltage pin
EN2	5	Chanel 2 Enable pin. This pin should be driven either high or low and must not be floating. Driving this pin high enables channel 2 output, while pulling it low puts Chanel 2 regulator into shutdown mode.
V _{IN2}	6	Input Voltage pin
V _{IN1}	7	Input Voltage pin
EN1	8	Chanel 1 Enable pin. This pin should be driven either high or low and must not be floating. Driving this pin high enables channel 1 output, while pulling it low puts Chanel 1 regulator into shutdown mode.
—	Thermal PAD	In PCB layout, prefer to use large copper area to cover this pad for better thermal dissipation, then connect this area to GND or leave it open. However do not use it as GND electrode function alone.

NEW PRODUCT

Functional Block Diagram

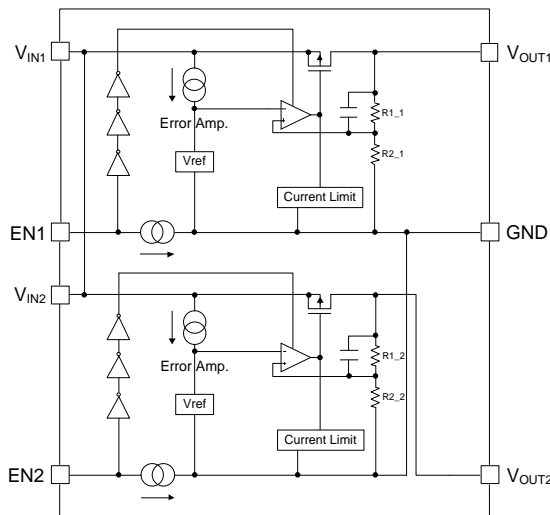

AP7344 (No Discharge)

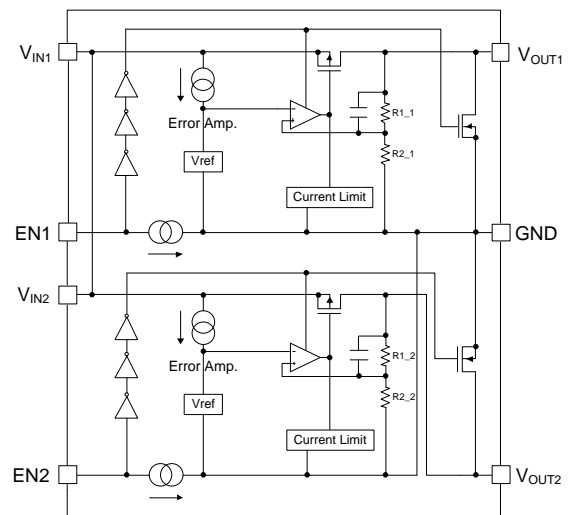

AP7344 (With Discharge)

Absolute Maximum Ratings (@T_A = +25°C, unless otherwise specified. Note 4)

Symbol	Parameter	Rating	Unit
V _{IN}	Input Voltage	6.0	V
V _{EN}	Input Voltage at EN Pins	6.0	V
V _{OUT}	Output Voltage	-0.3 to V _{IN} +0.3	V
I _{OUT}	Output Current	400	mA
P _D	Power Dissipation	600	mW
T _A	Operating Ambient Temperature	-40 to +85	°C
T _{STG}	Storage Temperature	-55 to +125	°C

Note 4: Stresses beyond those listed under Absolute Maximum Ratings may cause permanent damage to the device. These are stress ratings only and functional operation of the device at these conditions is not implied. Exposure to absolute-maximum-rated conditions for extended periods may affect device reliability.

Recommended Operating Conditions (@T_A = +25°C, unless otherwise specified.)

Symbol	Parameter	Min	Max	Unit
V _{IN}	Input Voltage	1.7	5.25	V
I _{OUT}	Output Current	0	300	mA
T _A	Operating Ambient Temperature	-40	+85	°C

Electrical Characteristics (@ $T_A = +25^\circ\text{C}$, $V_{IN} = V_{OUT} + 1\text{V}$ ($V_{OUT} > 1.5\text{V}$), $V_{IN} = 2.5\text{V}$ ($V_{OUT} \leq 1.5\text{V}$), $I_{OUT} = 1\text{mA}$, $C_{IN} = C_{OUT} = 1.0\mu\text{F}$, unless otherwise specified.)

Parameter	Conditions	Min	Typ	Max	Unit	
Input Voltage	$T_A = -40^\circ\text{C}$ to $+85^\circ\text{C}$	1.7	—	5.25	V	
Output Voltage Accuracy (Note 11)	$V_{IN} = (V_{OUT-Nom} + 1.0\text{V})$ to 5.25V , $I_{OUT} = 1\text{mA}$ to 300mA	$T_A = +25^\circ\text{C}$	-1	—	1	%
		$T_A = -40^\circ\text{C}$ to $+85^\circ\text{C}$	-1.5	—	1.5	
Line Regulation ($\Delta V_{OUT}/\Delta V_{IN}/V_{OUT}$)	$V_{IN} = (V_{OUT-Nom} + 1.0\text{V})$ to 5.25V , $I_{OUT} = 1.0\text{mA}$	—	0.02	0.1	%/V	
Load Regulation ($\Delta V_{OUT}/\Delta I_{OUT}$)	$V_{IN} = V_{OUT-Nom} + 1.0\text{V}$, $I_{OUT} = 1\text{mA}$ to 300mA	—	15	30	mV	
Quiescent Current (Note 6)	Set EN1 High, Set EN2 Low, or Set EN2 High, Set EN1 Low, No Load	—	50	70	μA	
	Set EN1/EN2 High, No Load	—	100	140	μA	
$I_{STANDBY}$	Set EN1/EN2 Low, No Load	—	0.1	1.0	μA	
Output Current	—	300	—	—	mA	
Fold-back Short Current (Note 7)	V_{OUT} short to ground	—	55	—	mA	
PSRR (Note 8)	$V_{IN} = (V_{OUT} + 1\text{V}) V_{DC} + 0.2\text{Vp-pAC}$, $V_{OUT} \geq 1.8\text{V}$, $I_{OUT} = 30\text{mA}$	—	75	—	dB	
Output Noise Voltage (Notes 8 & 9)	$BW = 10\text{Hz}$ to 100kHz , $I_{OUT} = 30\text{mA}$	—	60	—	μVrms	
Dropout Voltage (Note 5)	$I_{OUT} = 30\text{mA}$	$V_{OUT} \leq 1.2\text{V}$	—	0.48	0.59	V
		$1.2\text{V} < V_{OUT} \leq 1.4\text{V}$	—	0.39	0.50	
		$1.4\text{V} < V_{OUT} \leq 1.7\text{V}$	—	0.35	0.44	
		$1.7\text{V} < V_{OUT} \leq 2.1\text{V}$	—	0.30	0.39	
		$2.1\text{V} < V_{OUT} \leq 2.5\text{V}$	—	0.26	0.34	
		$2.5\text{V} < V_{OUT} \leq 3.0\text{V}$	—	0.25	0.30	
		$3.0\text{V} < V_{OUT} \leq 3.6\text{V}$	—	0.22	0.29	
Output Voltage Temperature Coefficient	$I_{OUT} = 30\text{mA}$, $T_A = -40^\circ\text{C}$ to $+85^\circ\text{C}$	—	± 30	—	ppm/ $^\circ\text{C}$	
EN Input Low Voltage	—	0	—	0.5	V	
EN Input High Voltage	—	1.3	—	5.25	V	
EN Input Leakage	$V_{EN} = 0\text{V}$, $V_{IN} = 5.0\text{V}$ or $V_{EN} = 5.0\text{V}$, $V_{IN} = 0\text{V}$	-1.0	—	1.0	μA	
On Resistance of N-channel for Auto-discharge (Note 10)	$V_{IN} = 4.0\text{V}$, $V_{EN} = 0\text{V}$ (Disabled)	D Version, Chanel 1 & 2	—	50	Ω	

- Notes:
- Dropout voltage is the voltage difference between the input and the output at which the output voltage drops 2% below its nominal value.
 - Quiescent current is defined here is the difference in current between the input and the output.
 - Short circuit current is measured with V_{OUT} pulled to GND.
 - This specification is guaranteed by design.
 - To make sure lowest environment noise minimizes the influence on noise measurement.
 - AP7344 has 2 options for output, built-in discharge and non-discharge
 - Potential multiple grades based on following output voltage accuracy.

Performance Characteristics

NEW PRODUCT

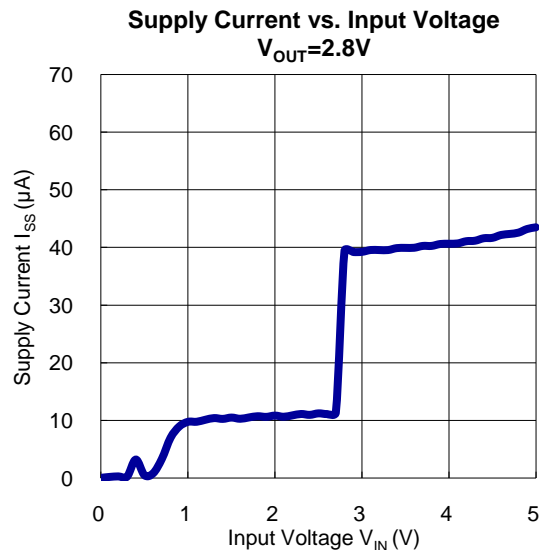
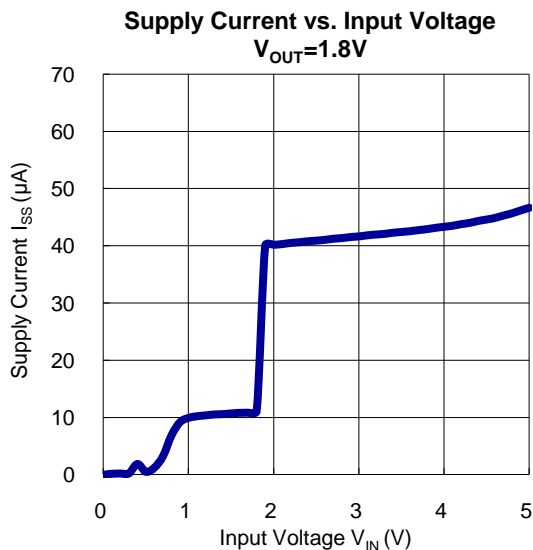
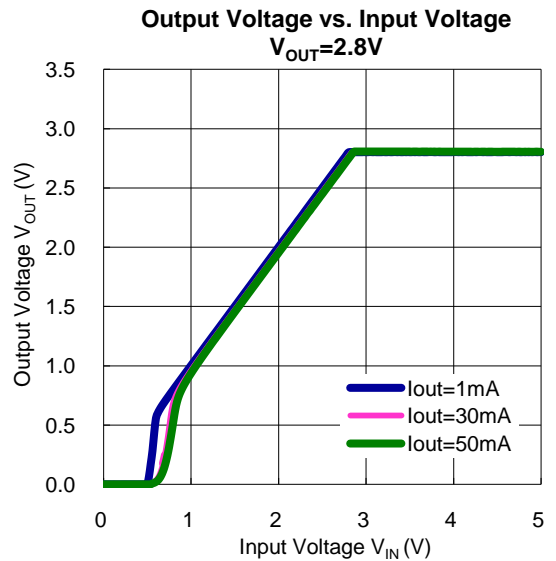
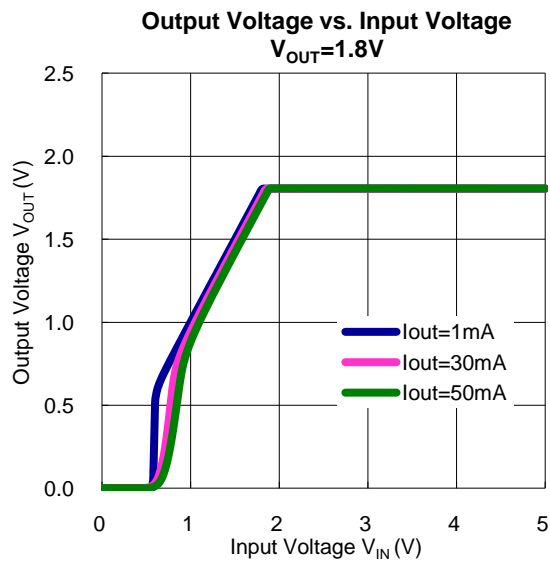
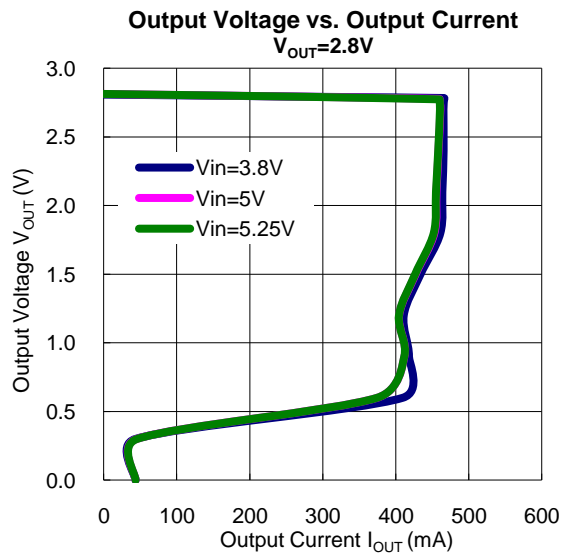
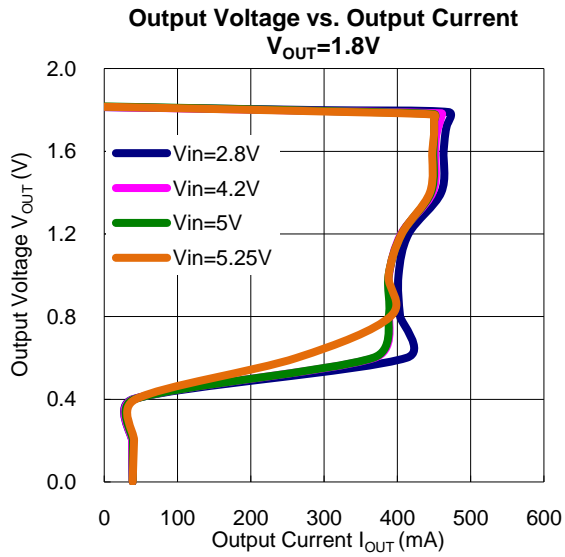

Performance Characteristics (Cont.)

NEW PRODUCT

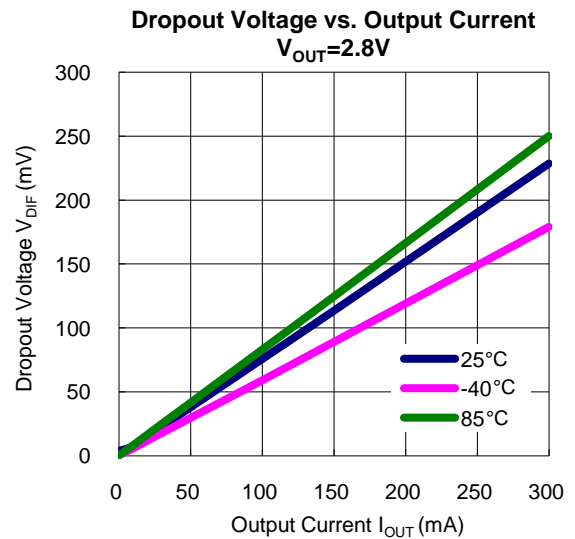
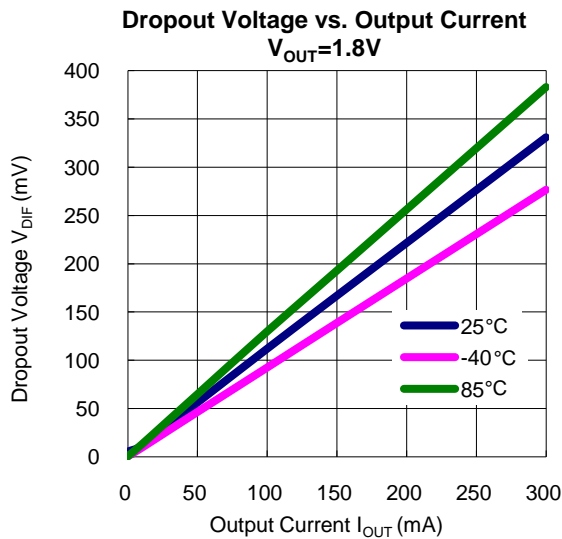
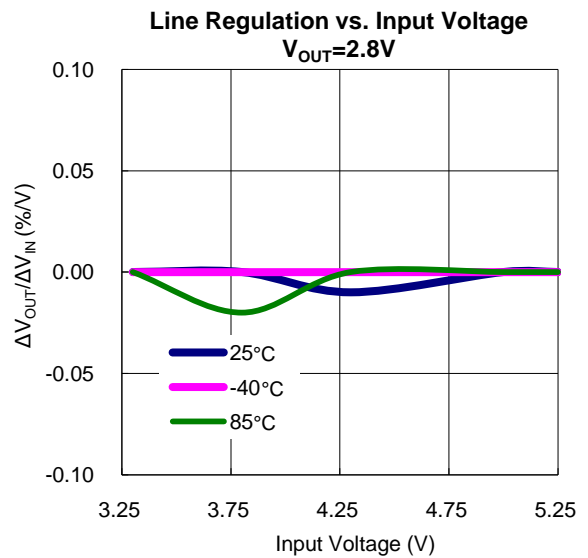
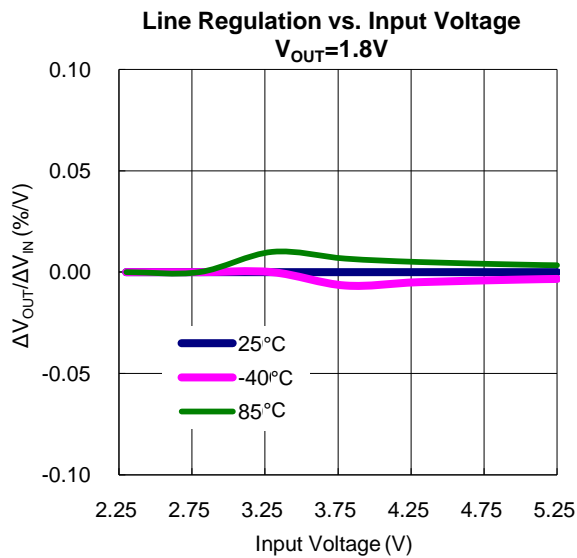
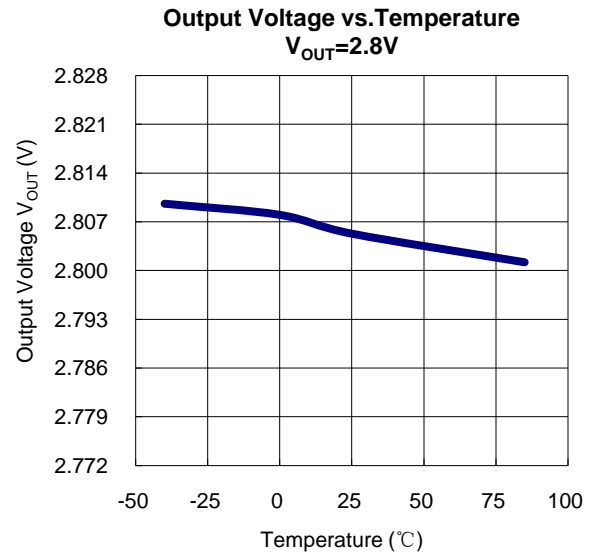
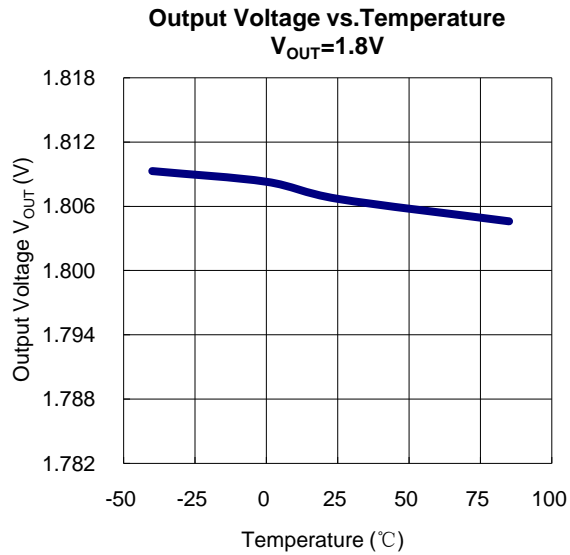

Performance Characteristics (Cont.)

NEW PRODUCT

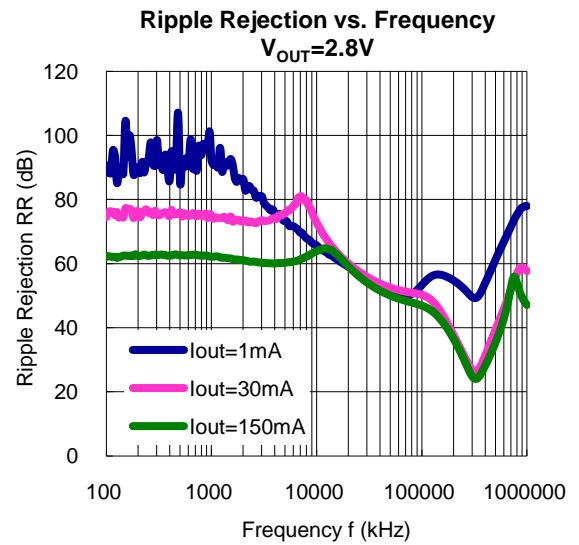
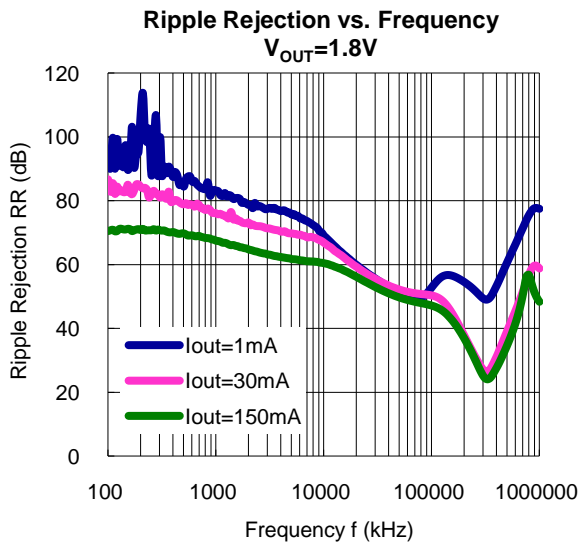
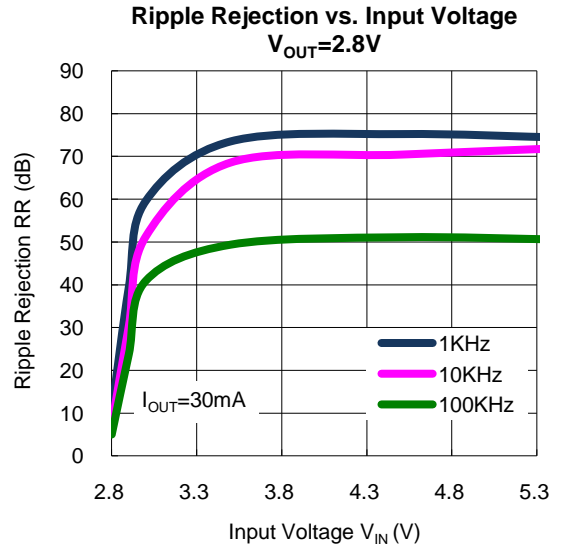
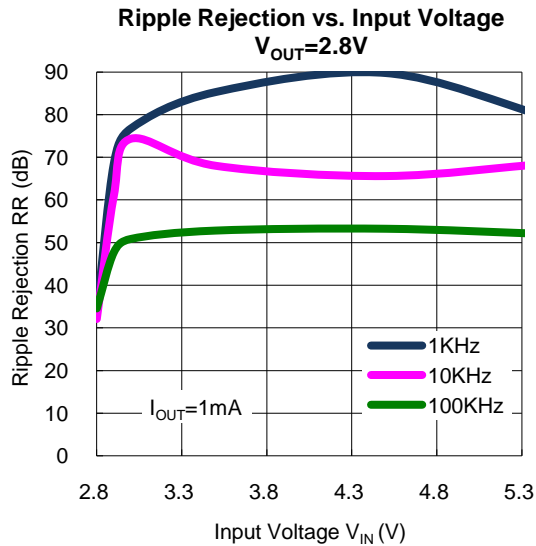
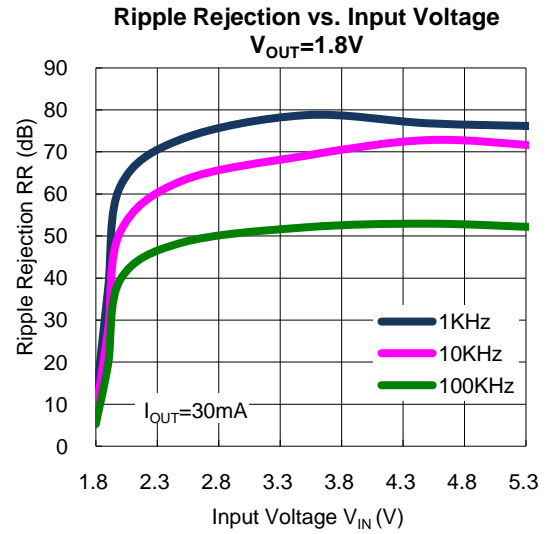
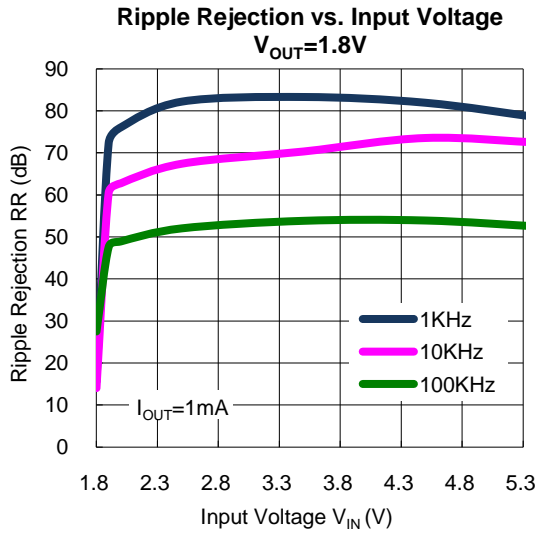

Performance Characteristics (Cont.)

Line Transient Response Waveforms
 $V_{OUT}=1.8V$

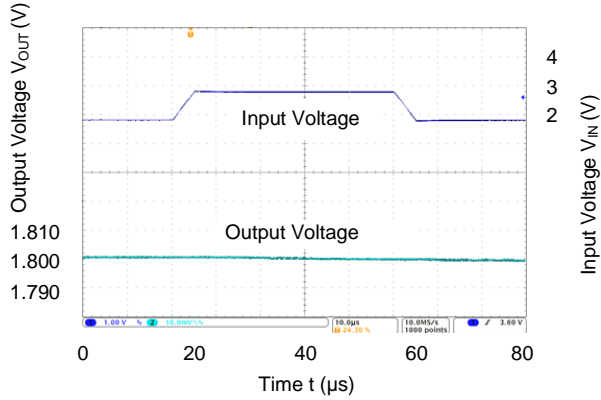

Line Transient Response Waveforms
 $V_{OUT}=2.8V$

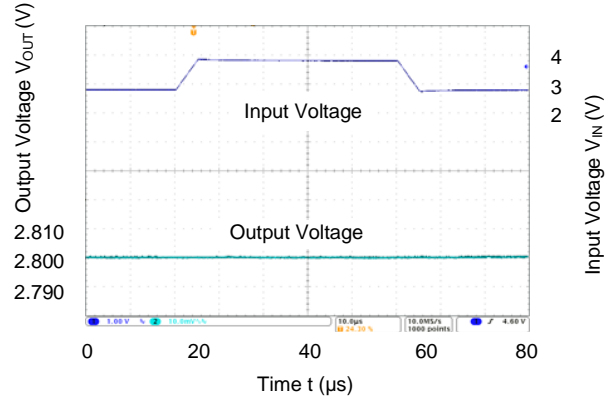

Load Transient Response Waveforms
 $V_{OUT}=1.8V, C_{OUT}=1\mu F$

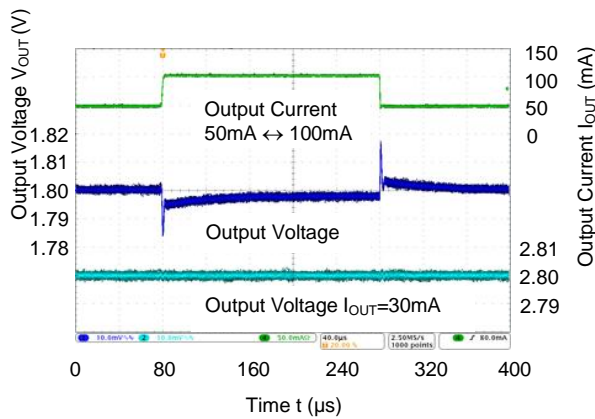

Load Transient Response Waveforms
 $V_{OUT}=1.8V, C_{OUT}=4.7\mu F$

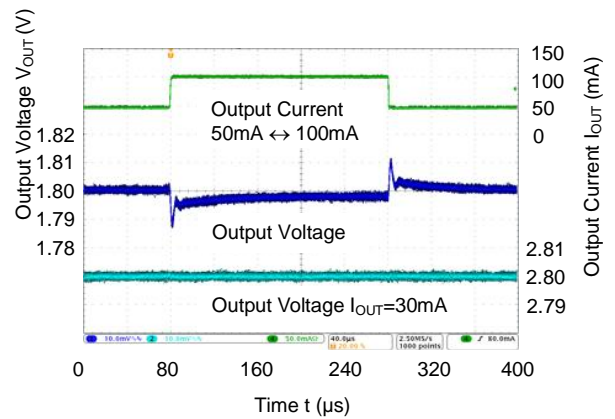

Load Transient Response Waveforms
 $V_{OUT}=2.8V, C_{OUT}=1\mu F$

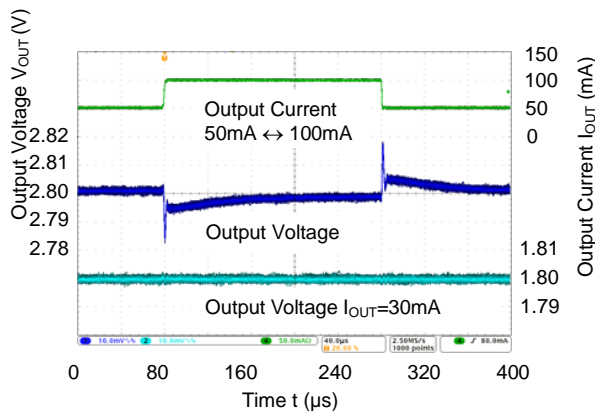

Load Transient Response Waveforms
 $V_{OUT}=2.8V, C_{OUT}=4.7\mu F$

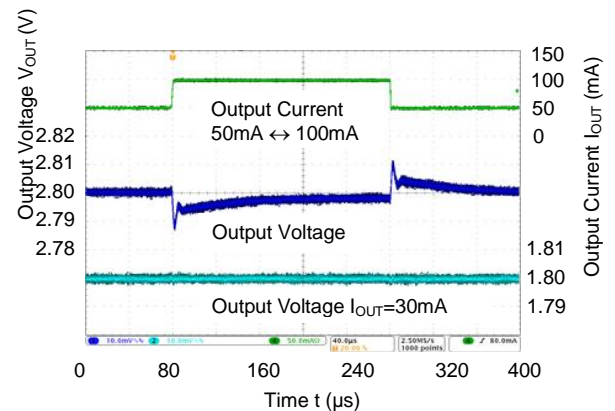

NEW PRODUCT

Performance Characteristics (Cont.)

Load Transient Response Waveforms
 $V_{OUT}=1.8V, C_{OUT}=1\mu F$

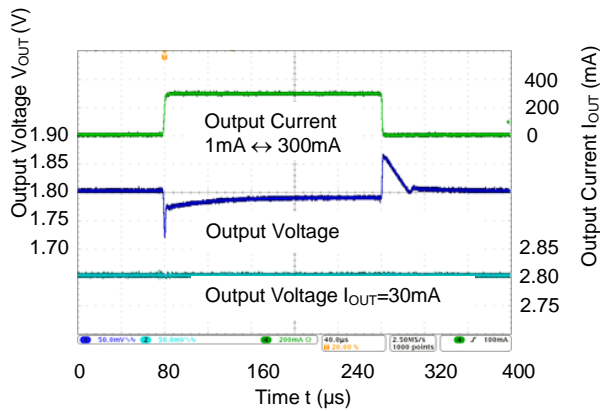

Load Transient Response Waveforms
 $V_{OUT}=1.8V, C_{OUT}=4.7\mu F$

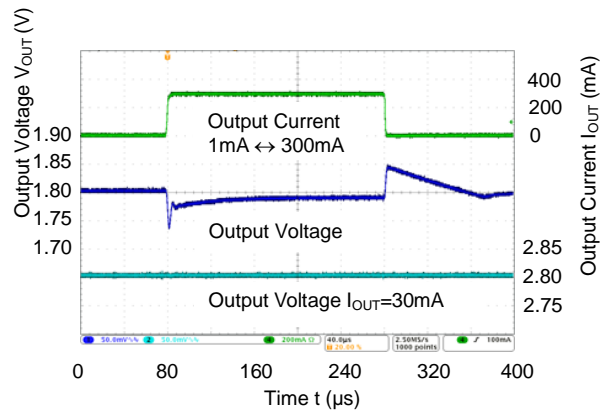

Load Transient Response Waveforms
 $V_{OUT}=2.8V, C_{OUT}=1\mu F$

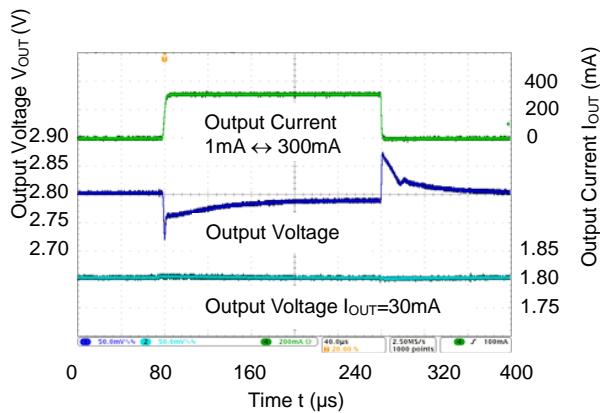

Load Transient Response Waveforms
 $V_{OUT}=2.8V, C_{OUT}=4.7\mu F$

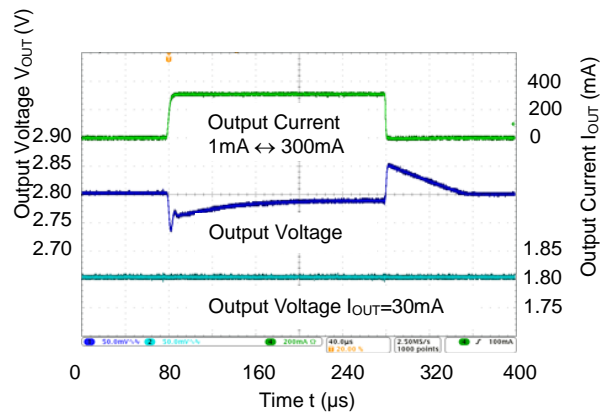

Turn On Waveforms
 $V_{OUT}=1.8V$

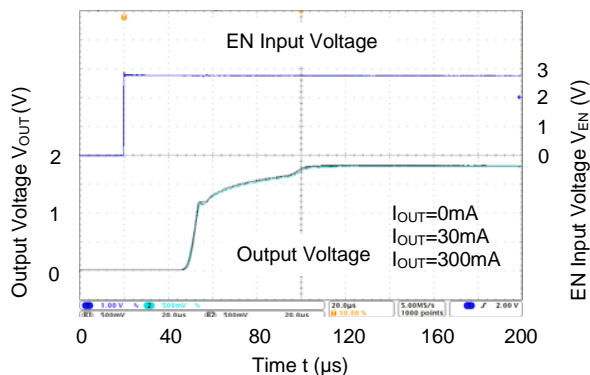

Turn On Waveforms
 $V_{OUT}=2.8V$

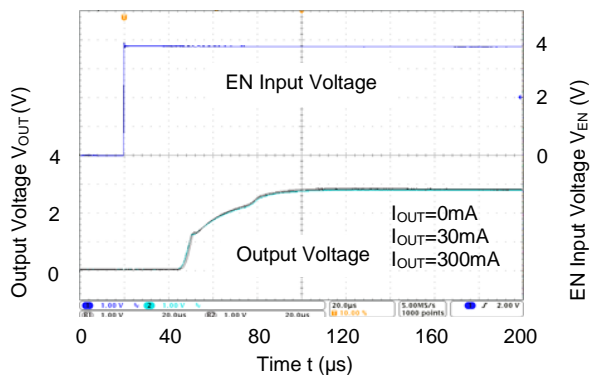

NEW PRODUCT

Performance Characteristics (Cont.)

Turn Off Waveforms
 $V_{OUT}=1.8V$

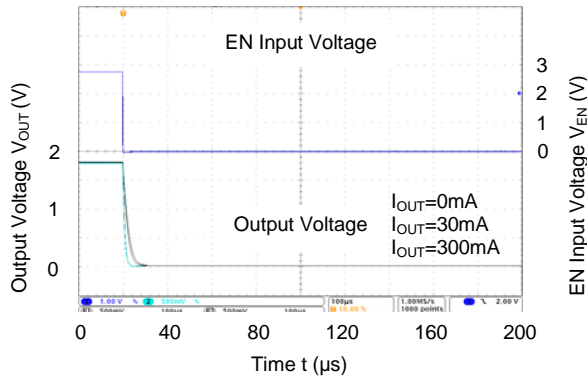

Turn Off Waveforms
 $V_{OUT}=2.8V$

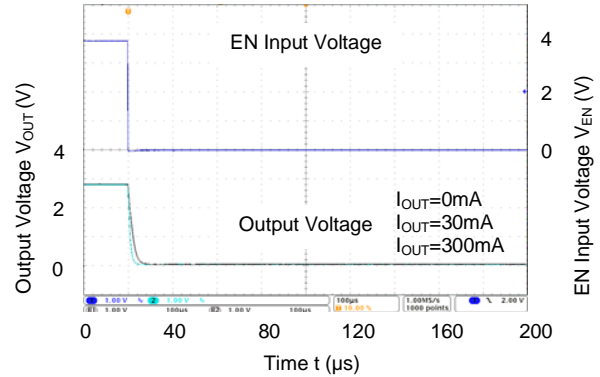

Application Information

Output Capacitor

An output capacitor (C_{OUT}) is needed to improve transient response and maintain stability. The AP7344 is stable with very small ceramic output capacitors. The ESR (Equivalent Series Resistance) and capacitance drives the selection. If the application has large load variations, it is recommended to utilize low-ESR bulk capacitors. It is recommended to place ceramic capacitors as close as possible to the load and the GND pins and care should be taken to reduce the impedance in the layout.

Input Capacitor

To prevent the input voltage from dropping during load steps, it is recommended to utilize an input capacitor (C_{IN}). A minimum $0.47\mu F$ ceramic capacitor is recommended between V_{IN} and GND pins to decouple input power supply glitch. This input capacitor must be located as close as possible to the device to assure input stability and reduce noise. For PCB layout, a wide copper trace is required for both V_{IN} and GND pins.

Enable Control

The AP7344 is turned on by setting the EN pins high, and is turned off by pulling it low. If this feature is not used, the EN pins should be tied to V_{IN} pins to keep the regulator output on at all time. To ensure proper operation, the signal source used to drive the EN pins must be able to swing above and below the specified turn-on/off voltage thresholds listed in the Electrical Characteristics section.

Short Circuit Protection

When V_{OUT} pins are short-circuit to GND, short circuit protection will be triggered and clamp the output current to approximately 60mA. This feature protects the regulator from over-current and damage due to overheating.

Layout Considerations

For good ground loop and stability, the input and output capacitors should be located close to the input, output, and GND pins of the device. The regulator GND pins should be connected to the external circuit ground to reduce voltage drop caused by trace impedance. Ground plane is generally used to reduce trace impedance. Wide trace should be used for large current paths from V_{IN} to V_{OUT} , and load circuit.

NEW PRODUCT

ESR vs. Output Current

Ceramic type output capacitor is recommended for this series; however, the other output capacitors with low ESR also can be used. The relations between I_{OUT} (Output Current) and ESR of an output capacitor are shown below. The stable region is marked as the hatched area in the graph.

Measurement conditions: Frequency Band: 10Hz to 2MHz, Temperature: -40°C to $+85^{\circ}\text{C}$.

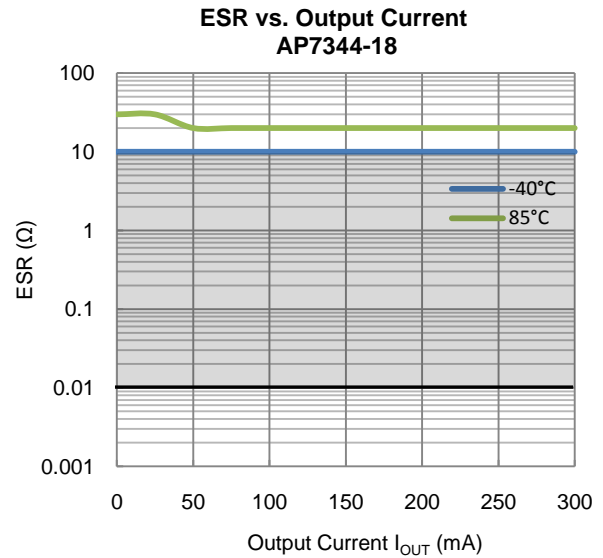
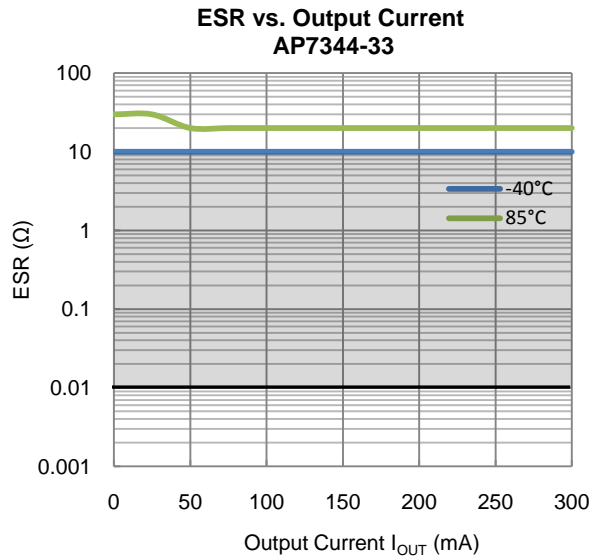

NEW PRODUCT

Ordering Information

AP7344X XXXXXX RH4 - 7

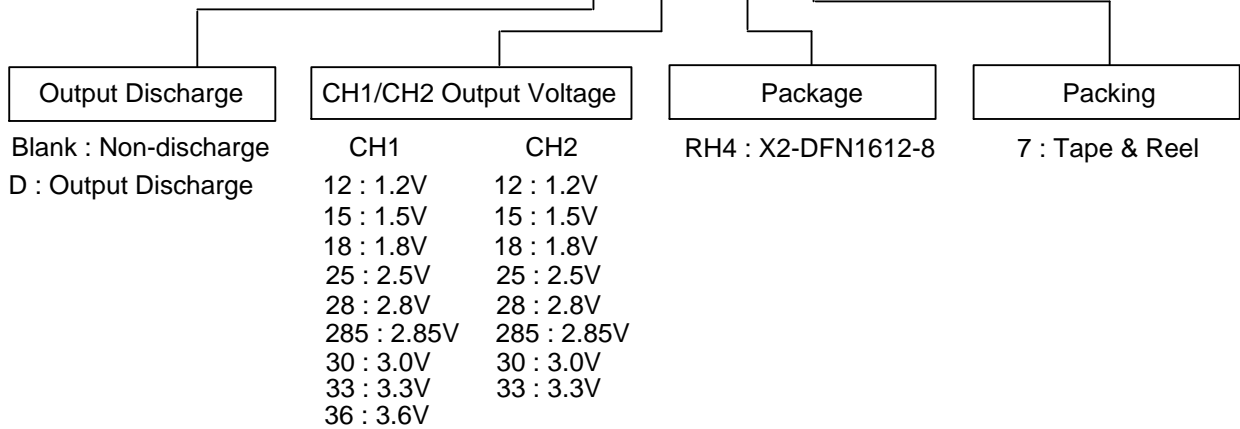

Part Number	Package Code	Packaging	7" Tape and Reel	
			Quantity	Part Number Suffix
AP7344-XXXXRH4-7	RH4	X2-DFN1612-8	5000/Tape & Reel	-7
AP7344D-XXXXXXRH4-7	RH4	X2-DFN1612-8	5000/Tape & Reel	-7

Marking Information

(1) X2-DFN1612-8

(Top View)

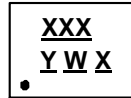

XXX : Identification Code
Y : Year : 0~9
W : Week : A~Z : 1~26 week;
 a~z : 27~52 week; z represents
 52 and 53 week
X : Internal code

Part Number	V _{OUT1} /V _{OUT2}	Package	Identification Code
AP7344-3028RH4-7	3.0V/2.8V	X2-DFN1612-8	DAA
AP7344-3328RH4-7	3.3V/2.8V	X2-DFN1612-8	DAB
AP7344-3318RH4-7	3.3V/1.8V	X2-DFN1612-8	DAC
AP7344D-1218RH4-7	1.2V/1.8V	X2-DFN1612-8	DAD
AP7344D-1528RH4-7	1.5V/2.8V	X2-DFN1612-8	DAE
AP7344D-1812RH4-7	1.8V/1.2V	X2-DFN1612-8	DAF
AP7344D-1815RH4-7	1.8V/1.5V	X2-DFN1612-8	DAG
AP7344D-1818RH4-7	1.8V/1.8V	X2-DFN1612-8	DAH
AP7344D-1828RH4-7	1.8V/2.8V	X2-DFN1612-8	DAJ
AP7344D-1833RH4-7	1.8V/3.3V	X2-DFN1612-8	DAK
AP7344D-2518RH4-7	2.5V/1.8V	X2-DFN1612-8	DAM
AP7344D-2812RH4-7	2.8V/1.2V	X2-DFN1612-8	DAN
AP7344D-2818RH4-7	2.8V/1.8V	X2-DFN1612-8	DAP
AP7344D-2825RH4-7	2.8V/2.5V	X2-DFN1612-8	DAR
AP7344D-2833RH4-7	2.8V/3.3V	X2-DFN1612-8	DAS
AP7344D-2828RH4-7	2.8V/2.8V	X2-DFN1612-8	DAT
AP7344D-285285RH4-7	2.85V/2.85V	X2-DFN1612-8	DAU
AP7344D-3018RH4-7	3.0V/1.8V	X2-DFN1612-8	DAV
AP7344D-3028RH4-7	3.0V/2.8V	X2-DFN1612-8	DAW
AP7344D-3030RH4-7	3.0V/3.0V	X2-DFN1612-8	DAX
AP7344D-3318RH4-7	3.3V/1.8V	X2-DFN1612-8	DAY
AP7344D-3328RH4-7	3.3V/2.8V	X2-DFN1612-8	DAZ
AP7344D-3330RH4-7	3.3V/3.0V	X2-DFN1612-8	DA2
AP7344D-3333RH4-7	3.3V/3.3V	X2-DFN1612-8	DA3
AP7344D-3612RH4-7	3.6V/1.2V	X2-DFN1612-8	DA4

NEW PRODUCT

Package Outline Dimensions

Please see <http://www.diodes.com/package-outlines.html> for the latest version.

(1) Package Type: X2-DFN1612-8

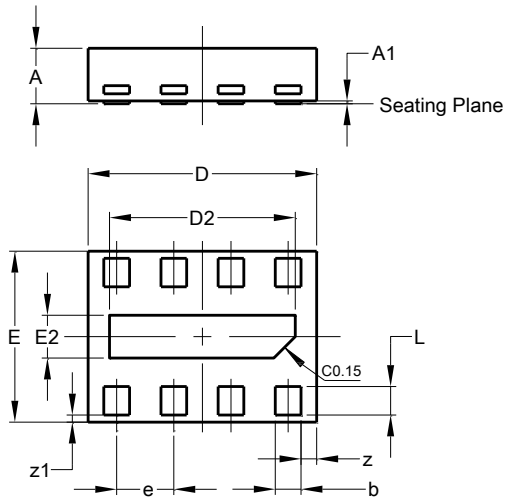

X2-DFN1612-8			
Dim	Min	Max	Typ
A	—	0.40	0.39
A1	0.00	0.05	0.02
b	0.13	0.23	0.18
D	1.55	1.65	1.60
D2	1.25	1.35	1.30
E	1.15	1.25	1.20
E2	0.25	0.35	0.30
e	—	—	0.40
L	0.15	0.25	0.20
z	—	—	0.11
z1	—	—	0.05
All Dimensions in mm			

Suggested Pad Layout

Please see <http://www.diodes.com/package-outlines.html> for the latest version.

(1) Package Type: X2-DFN1612-8

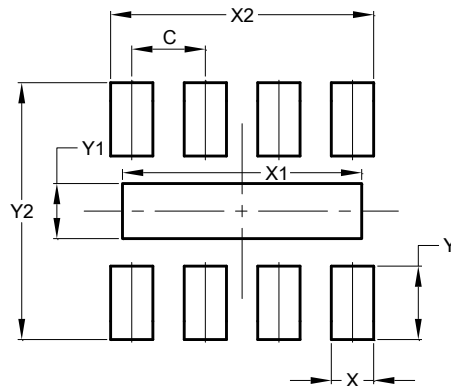

Dimensions	Value (in mm)
C	0.400
X	0.230
X1	1.300
X2	1.430
Y	0.400
Y1	0.300
Y2	1.400

Tape Orientation

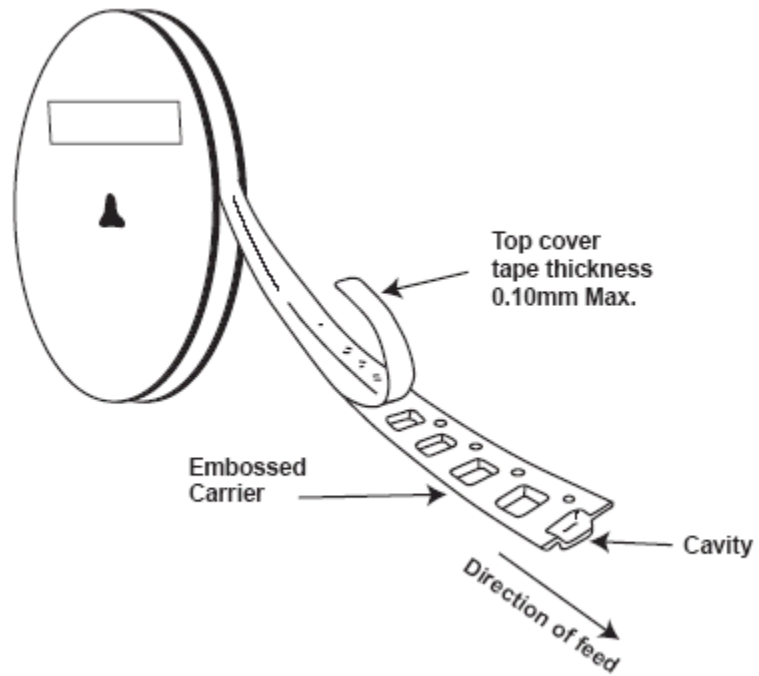
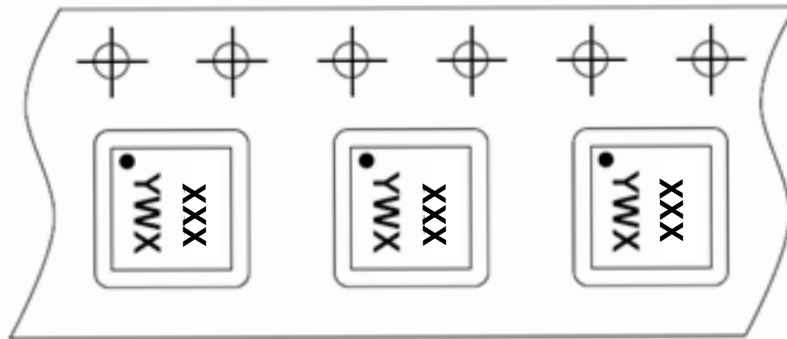

Note: The taping orientation of the other package type can be found on our website at <http://www.diodes.com/datasheets/ap02007.pdf>

IMPORTANT NOTICE

DIODES INCORPORATED MAKES NO WARRANTY OF ANY KIND, EXPRESS OR IMPLIED, WITH REGARDS TO THIS DOCUMENT, INCLUDING, BUT NOT LIMITED TO, THE IMPLIED WARRANTIES OF MERCHANTABILITY AND FITNESS FOR A PARTICULAR PURPOSE (AND THEIR EQUIVALENTS UNDER THE LAWS OF ANY JURISDICTION).

Diodes Incorporated and its subsidiaries reserve the right to make modifications, enhancements, improvements, corrections or other changes without further notice to this document and any product described herein. Diodes Incorporated does not assume any liability arising out of the application or use of this document or any product described herein; neither does Diodes Incorporated convey any license under its patent or trademark rights, nor the rights of others. Any Customer or user of this document or products described herein in such applications shall assume all risks of such use and will agree to hold Diodes Incorporated and all the companies whose products are represented on Diodes Incorporated website, harmless against all damages.

Diodes Incorporated does not warrant or accept any liability whatsoever in respect of any products purchased through unauthorized sales channel. Should Customers purchase or use Diodes Incorporated products for any unintended or unauthorized application, Customers shall indemnify and hold Diodes Incorporated and its representatives harmless against all claims, damages, expenses, and attorney fees arising out of, directly or indirectly, any claim of personal injury or death associated with such unintended or unauthorized application.

Products described herein may be covered by one or more United States, international or foreign patents pending. Product names and markings noted herein may also be covered by one or more United States, international or foreign trademarks.

This document is written in English but may be translated into multiple languages for reference. Only the English version of this document is the final and determinative format released by Diodes Incorporated.

LIFE SUPPORT

Diodes Incorporated products are specifically not authorized for use as critical components in life support devices or systems without the express written approval of the Chief Executive Officer of Diodes Incorporated. As used herein:

A. Life support devices or systems are devices or systems which:

1. are intended to implant into the body, or
2. support or sustain life and whose failure to perform when properly used in accordance with instructions for use provided in the labeling can be reasonably expected to result in significant injury to the user.

B. A critical component is any component in a life support device or system whose failure to perform can be reasonably expected to cause the failure of the life support device or to affect its safety or effectiveness.

Customers represent that they have all necessary expertise in the safety and regulatory ramifications of their life support devices or systems, and acknowledge and agree that they are solely responsible for all legal, regulatory and safety-related requirements concerning their products and any use of Diodes Incorporated products in such safety-critical, life support devices or systems, notwithstanding any devices- or systems-related information or support that may be provided by Diodes Incorporated. Further, Customers must fully indemnify Diodes Incorporated and its representatives against any damages arising out of the use of Diodes Incorporated products in such safety-critical, life support devices or systems.

Copyright © 2016, Diodes Incorporated

www.diodes.com

Mouser Electronics

Authorized Distributor

Click to View Pricing, Inventory, Delivery & Lifecycle Information:

Diodes Incorporated:

[AP7344D-3333RH4-7](#) [AP7344D-3330RH4-7](#) [AP7344D-3018RH4-7](#) [AP7344D-2828RH4-7](#) [AP7344D-285285RH4-7](#)
[AP7344D-1528RH4-7](#) [AP7344-3028RH4-7](#) [AP7344D-3030RH4-7](#) [AP7344D-2818RH4-7](#) [AP7344D-2833RH4-7](#)
[AP7344D-1828RH4-7](#) [AP7344D-2812RH4-7](#) [AP7344D-3612RH4-7](#) [AP7344D-3028RH4-7](#) [AP7344D-1218RH4-7](#)
[AP7344D-2825RH4-7](#) [AP7344-3328RH4-7](#) [AP7344D-3328RH4-7](#) [AP7344D-3318RH4-7](#) [AP7344D-1818RH4-7](#)
[AP7344D-1815RH4-7](#) [AP7344D-1833RH4-7](#) [AP7344D-1812RH4-7](#) [AP7344-3318RH4-7](#) [AP7344D-2518RH4-7](#)