

# AirMatrix™ 2410 Fast Acting Surface Mount Fuses



## Features:

- Fast acting at 200% overload current level
- Excellent inrush current withstanding capability
- Fiberglass enforced epoxy fuse body
- Copper or copper alloy composite fuse link
- Copper termination with nickel and tin plating
- Halogen free, RoHS compliant and 100% lead-free
- Operating temperature range: -55°C to +125°C (with de-rating)



## Clearing Time Characteristics:

% of Current Rating	Clearing Time at 25°C	
100%	4 hours min.	
200%(0.50~10.0 A)	0.01 seconds min.	5 seconds max.
200%(12.0~20.0 A)	0.01 seconds min.	20 seconds max.

## Shape and Dimensions:

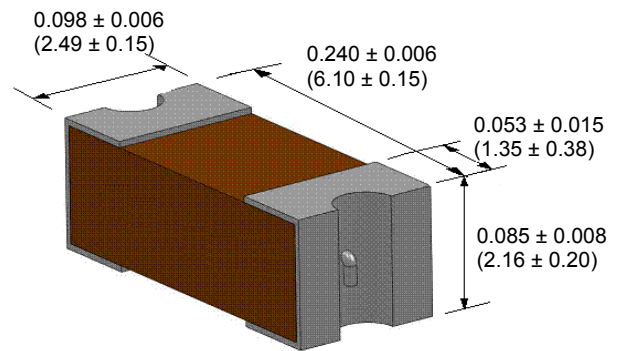

## Agency Approval:

- Recognized Under the Components Program of Underwriters Laboratories. File Number: E232989
- PSE Certificate No: NBK180711-JP13710
- TUV File Number: 50209083
- CQC No.: CQC11012065955

## Patents: Pending

## Typical Applications:

- Power Supply, e.g. DC/DC converters, DC/AC inverters, Backlight drivers , etc.
- Consumer Electronics, e.g. LCD TVs, PDP, DVDs, PCM , etc.
- Communication Technology, e.g. Telecom systems, Networking, Modems, Routers, Changers, Base stations , etc.
- Office Automation Electronics
- IT Products, e.g. LCD monitors, Notebooks, PC servers, etc.

## Recommended Land Pattern:

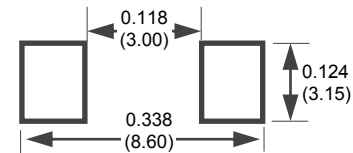

Inch (mm)

# AirMatrix™ 2410 Fast Acting Surface Mount Fuses



## Marking: White marking character code

0.5 A:C; 0.63 A:S; 0.75 A:D; 1.0 A:E; 1.25 A:F; 1.5 A:G; 2.0 A:I; 2.5 A:J; 3.0 A:K; 3.15 A:V;  
3.5 A:L; 4.0 A:M; 5.0 A:N; 6.3 A:O; 7.0 A:P; 8.0 A:R; 10.0 A:Q; 12.0 A:X; 15.0 A:Y; 20.0 A:Z.

## Ordering Information:

Part Number	Current Rating (A)	Voltage Rating (V)		Interrupting Rating	Nominal Cold DCR ( $\Omega$ ) <sup>1</sup>	Nominal I <sup>2</sup> t (A <sup>2</sup> s) <sup>2</sup>	Agency Approval			
		AC	DC				UL	PSE	TUV	CQC
AF2-0.50V125TM	0.5	250	125	<b>TUV:</b> 0.5 ~ 2 A 100 A @ 250 VAC 50 A @ 125 VDC  <b>CQC:</b> 0.5 A, 1 A, 2 A 100 A @ 250 VAC 50 A @ 125 VDC  <b>PSE:</b> 1 ~ 5 A 50 A @ 125 VAC  <b>UL:</b> 0.5 ~ 2 A 100A @ 250VAC 1.5 ~ 8 A 50A @ 125VAC 0.5 ~ 8 A 50 A @ 125 VDC 300 A @ 32 VDC	0.231	0.1	✓		✓	✓
AF2-0.63V125TM	0.63	250	125		0.174	0.16	✓		✓	
AF2-0.75V125TM	0.75	250	125		0.148	0.23	✓			
AF2-1.00V125TM	1.0	250	125		0.093	0.59	✓	✓	✓	✓
AF2-1.25V125TM	1.25	250	125		0.07	0.96	✓	✓	✓	
AF2-1.50V125TM	1.5	250	125		0.062	1.19	✓	✓		
AF2-2.00V125TM	2.0	250	125		0.042	2.75	✓	✓	✓	✓
AF2-2.50V125TM	2.5	125	125		0.031	1.21	✓	✓		
AF2-3.00V125TM	3.0	125	125		0.0249	1.73	✓	✓		
AF2-3.15V125TM	3.15	125	125		0.0232	2.2	✓	✓		
AF2-3.50V125TM	3.5	125	125		0.022	2.5	✓	✓		
AF2-4.00V125TM	4.0	125	125		0.0172	4.1	✓	✓		
AF2-5.00V125TM	5.0	125	125		0.0143	5.9	✓	✓		
AF2-6.30V125TM	6.3	125	125		0.01	12.5	✓			
AF2-7.00V125TM	7.0	125	125		0.0094	14.2	✓			
AF2-8.00V125TM	8.0	125	125		0.0086	20.3	✓			
AF2-10.0V125TM	10.0	125	125	35 A @ 125 VAC 50 A @ 125 VDC 300 A @ 32 VDC	0.0066	29.2	✓			
AF2-12.0V065TM	12.0	65	65	50 A @ 65 VAC 50 A @ 65 VDC	0.0053	49.2	✓			
AF2-15.0V065TM	15.0	65	65	300 A @ 32 VDC	0.0038	102.5	✓			
AF2-20.0V065TM	20.0	65	65	50 A @ 65 VAC 100 A @ 65 VDC 300 A @ 32 VDC	0.0034	126.2	✓			

1. Measured at  $\leq 10\%$  rated current and 25°C ambient
2. Melting I<sup>2</sup>t at 0.001 seconds pre-arcing time

# AirMatrix™ 2410 Fast Acting Surface Mount Fuses



## Average Pre-arcing Time Curves

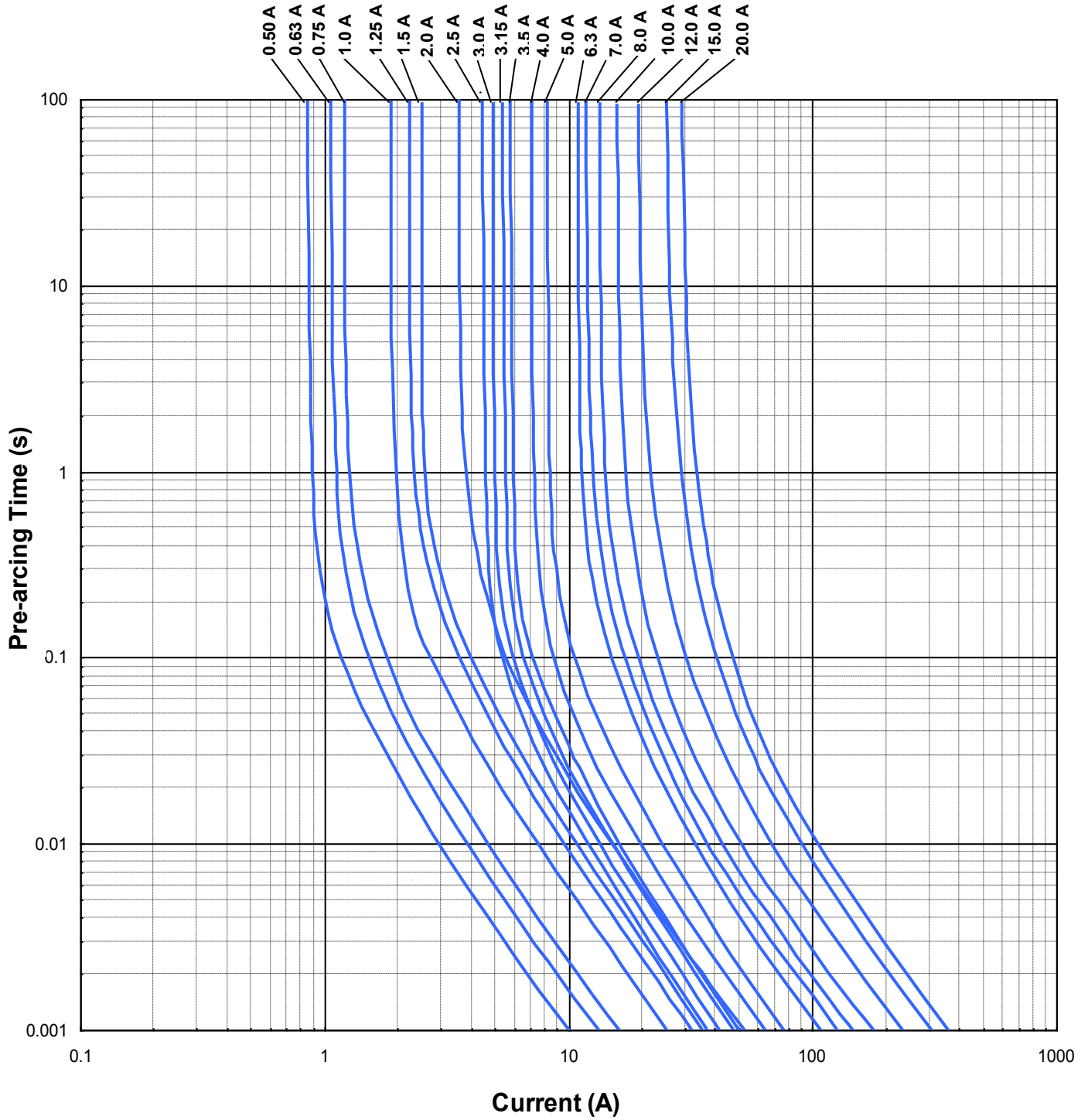

**AirMatrix™ 2410 Fast Acting Surface Mount Fuses**

**Average  $I^2t$  vs.  $t$  Curves**

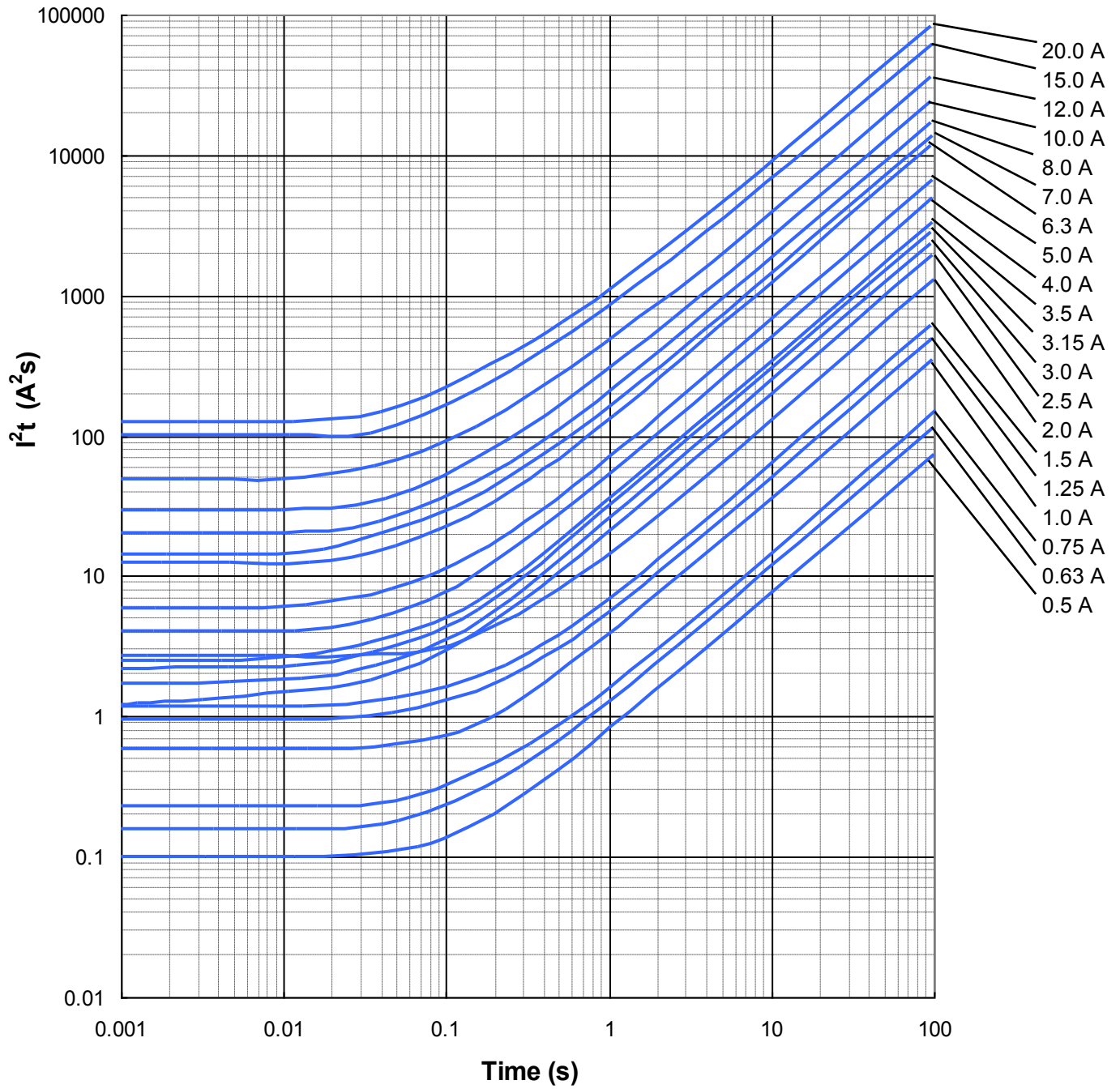

# AirMatrix™ 2410 Fast Acting Surface Mount Fuses



## Product Identification:

AF2 1.00 V125 T M

(1) (2) (3) (4) (5)

- (1) Series code: AF2
- (2) Current rating code: 1.00 - 1.00 A
- (3) Voltage rating code: V125 - 125 VDC
- (4) Package code:
  - T - Tape & Reel
  - B - Bulk
- (5) Marking code: M - with mark

## Environmental Tests:

Reliability Test	Test Condition and Requirement	Test Reference
Reflow & Bend	3 reflows at 245°C followed by a 2 mm bend, 20% DCR change max. (10% for $\leq 1$ A), no mechanical damage	Refer to AEM QIQ034 ,QIQ048 IEC60068-2-21
Solderability	245°C, 5 seconds, new solder coverage 90% minimum	MIL-STD-202 Method 208
Soldering Heat Resistance	260°C, 10 seconds, 20% DCR change max. (10% for $\leq 1$ A), new solder coverage 75% minimum	MIL-STD-202 Method 210
Life	25°C, 2000 hours, 80% rated current (75% for $< 1$ A), voltage drop change $\leq \pm 20\%$	Refer to AEM QIQ106
Thermal Shock	-65°C to +125°C, 100 cycles, 10% DCR change max., no mechanical damage	MIL-STD-202 Method 107
Mechanical Vibration	5 – 3000 Hz, 0.4 inch double amplitude or 30 G peak, 10% DCR change max., no mechanical damage	MIL-STD-202 Method 204
Mechanical Shock	1500 G, 0.5 milliseconds, half-sine shocks, 10% DCR change max., no mechanical damage	MIL-STD-202 Method 213
Salt Spray	5% salt solution, 48 hour exposure, 10% DCR change max., no excessive corrosion	MIL-STD-202 Method 101
Moisture Resistance	10 cycles, 15% DCR change max., no excessive corrosion	MIL-STD-202 Method 106

# AirMatrix™ 2410 Fast Acting Surface Mount Fuses

## Soldering Temperature Profiles

### Recommended Temperature Profile for Reflow Soldering

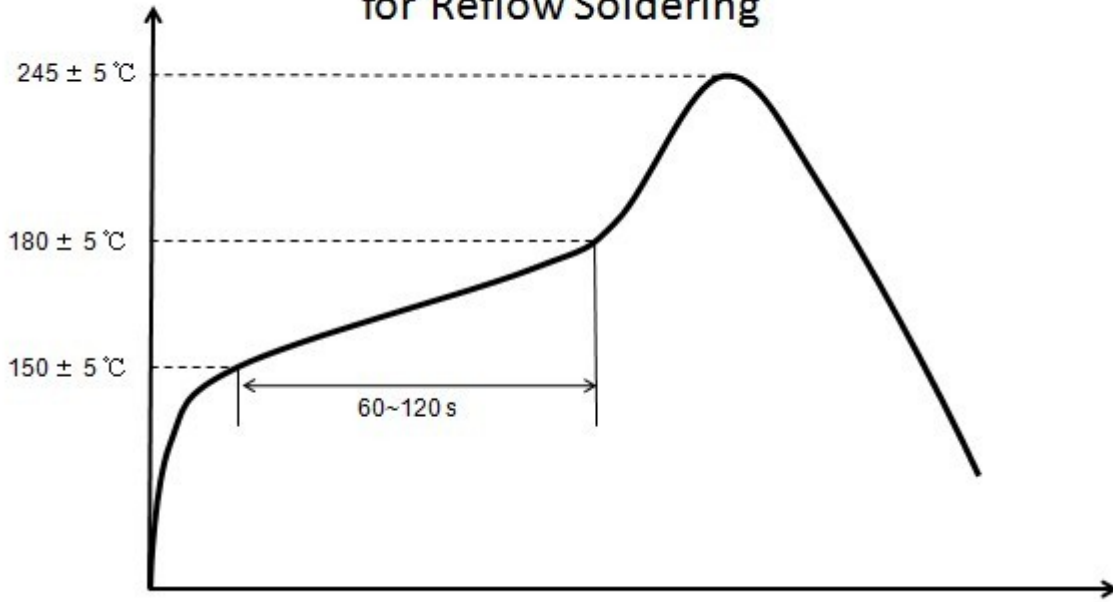

### Recommended Temperature Profile for Wave Soldering

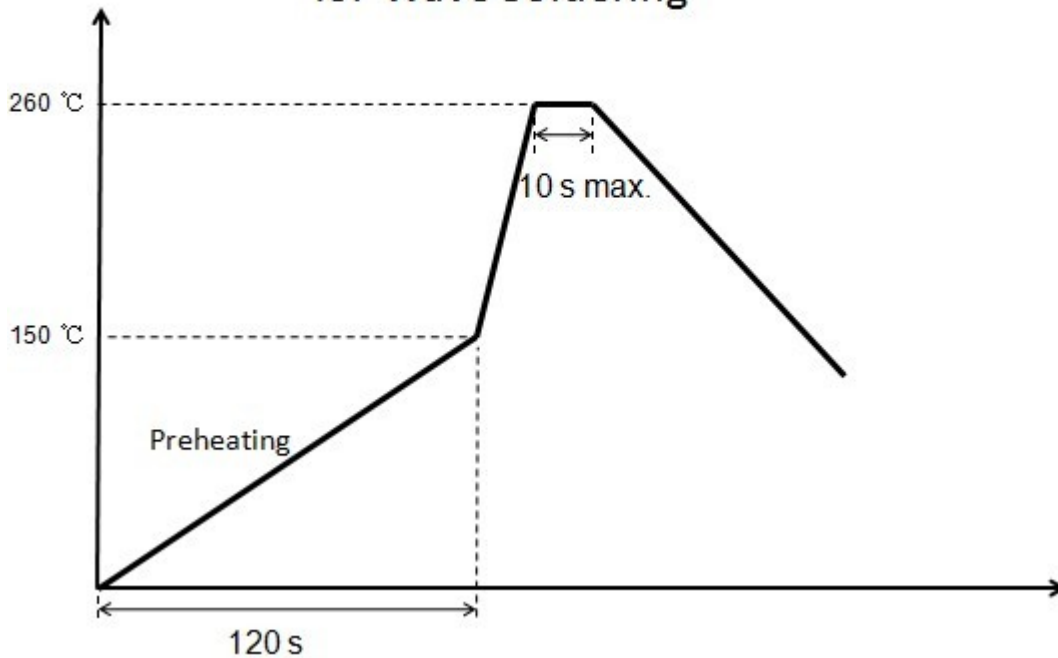



# AirMatrix™ 2410 Fast Acting Surface Mount Fuses



## Fuse Selection and Temperature De-rating Guideline

The ambient temperature affects the current carrying capacity of fuses. When a fuse is operating at a temperature higher than 25°C, the fuse shall be “de-rated”.

To select a fuse from the catalog, the following rule may be followed:  
 Catalog Fuse Current Rating = Nominal Operating Current / 0.75 / % De-rating at the maximum operating temperature.

Example: At maximum operating temperature of 65°C, % De-rating is 90%. The nominal operating current is 4 A. The current rating for fuse selected from the catalog shall be:  
 $4 / 0.75 / 90\% = 5.9$  or 6.3 A.

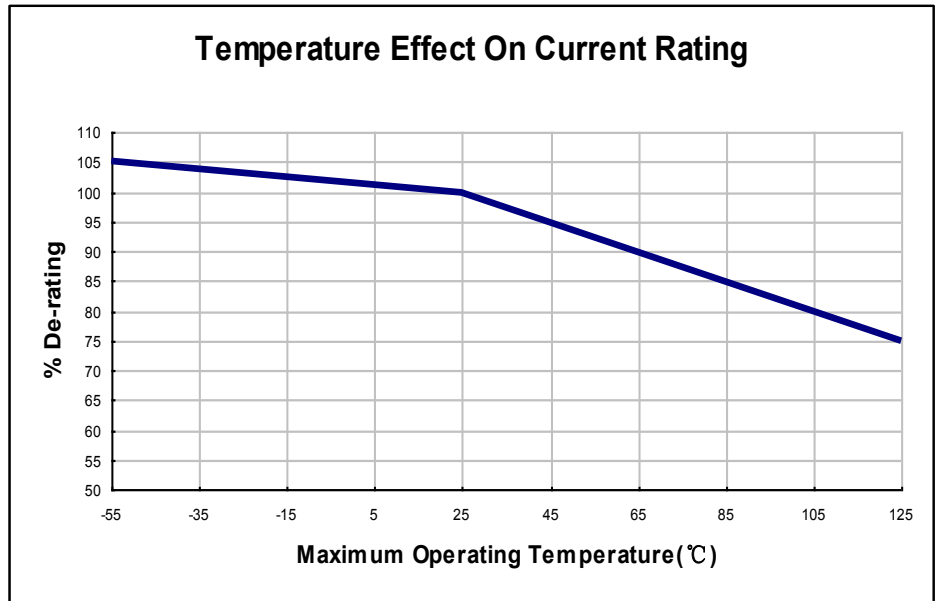

## Packaging Data

Chip Size	Parts on 7 inch (178 mm) Reel
2410 (6125)	2,000