

## Description

The AP7343 is a low dropout regulator with high output voltage accuracy, low  $R_{DS(ON)}$ , high PSRR, low output noise and low quiescent current. This regulator is based on a CMOS process.

The AP7343 includes a voltage reference, error amplifier, current limit circuit and an enable input to turn it on and off. With the integrated resistor network fixed output voltage versions can be delivered.

With its low power consumption and line and load transient response, the AP7343 is well suited for low power handheld communication equipment.

The AP7343 is packaged in X2-DFN1010-4 (Type B) and SOT25 packages, allows for smallest footprint and dense PCB layout.

## Features

- Low  $V_{IN}$  and Wide  $V_{IN}$  Range: 1.7V to 5.25V
- Guarantee Output Current: 300mA
- $V_{OUT}$  Accuracy  $\pm 1\%$
- Ripple Rejection 75dB at 1kHz
- Low Output Noise, 60 $\mu$ Vrms from 10Hz to 100kHz
- Quiescent Current as Low as 35 $\mu$ A
- $V_{OUT}$  Fixed 0.9V to 3.6V
- **Totally Lead-Free & Fully RoHS Compliant (Notes 1 & 2)**
- **Halogen and Antimony Free. "Green" Device (Note 3)**

## Pin Assignments

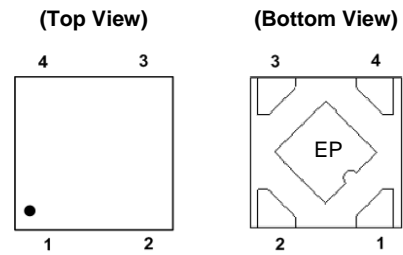

**X2-DFN1010-4 (Type B)**

PIN1 –  $V_{OUT}$ , PIN2 – GND, PIN3 – EN, PIN4 –  $V_{IN}$

**(Top View)**

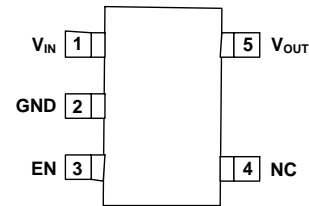

**SOT25**

## Applications

- Smart Phone/Tablet
- RF Supply
- Cameras
- Portable Video
- Portable Media Player
- Wireless Adapter
- Wireless Communication

- Notes:
1. No purposely added lead. Fully EU Directive 2002/95/EC (RoHS) & 2011/65/EU (RoHS 2) compliant.
  2. See [http://www.diodes.com/quality/lead\\_free.html](http://www.diodes.com/quality/lead_free.html) for more information about Diodes Incorporated's definitions of Halogen- and Antimony-free, "Green" and Lead-free.
  3. Halogen- and Antimony-free "Green" products are defined as those which contain <900ppm bromine, <900ppm chlorine (<1500ppm total Br + Cl) and <1000ppm antimony compounds.

## Typical Applications Circuit

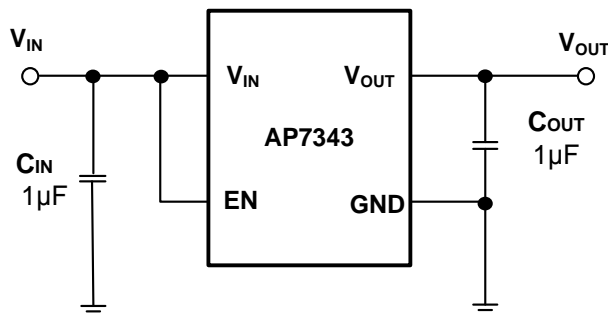

## Pin Descriptions

Pin Number		Pin Name	Function
X2-DFN1010-4 (Type B)	SOT25		
1	5	V <sub>OUT</sub>	Power Output Pin
2	2	GND	Ground
3	3	EN	Enable Pin This pin should be driven either high or low and must not be floating. Driving this pin high enables the regulator, while pulling it low puts the regulator into shutdown mode
4	1	V <sub>IN</sub>	Power Input Pin
—	4	NC	No connection
EP	—	Exposed Pad	In PCB layout, prefer to use large copper area to cover this pad for better thermal dissipation, then connect this area to GND or leave it open. However, do not use it as GND electrode function alone

## Functional Block Diagram

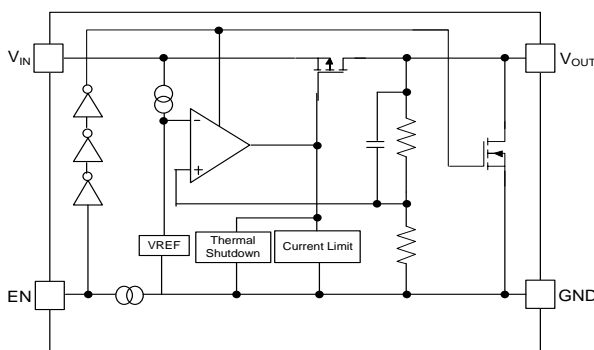

AP7343 (With Discharge)

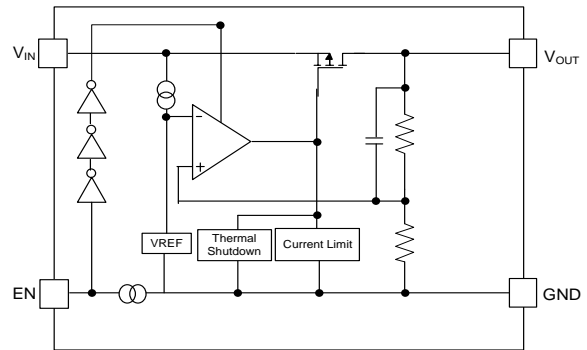

AP7343 (Without Discharge)

## Absolute Maximum Ratings (Note 4) (@T<sub>A</sub> = +25°C, unless otherwise specified.)

Symbol	Parameter	Ratings	Unit
ESD HBM	Human Body Mode ESD Protection	> 2	KV
ESD MM	Machine Mode ESD Protection	> 200	V
V <sub>IN</sub>	Input Voltage	6.0	V
V <sub>EN</sub>	Input Voltage for EN Pin	6.0	V
V <sub>OUT</sub>	Output Voltage	-0.3 to V <sub>IN</sub> + 0.3	V
I <sub>OUT</sub>	Output Current	400	mA
P <sub>D</sub>	Power Dissipation	400	mW
T <sub>A</sub>	Operating Ambient Temperature	-40 to +85	°C
T <sub>STG</sub>	Storage Temperature	-55 to +125	°C

- Note:
- Stresses beyond those listed under Absolute Maximum Ratings may cause permanent damage to the device. These are stress ratings only and functional operation of the device at these conditions is not implied. Exposure to absolute-maximum-rated conditions for extended period may affect device reliability.
  - Ratings apply to ambient temperature at +25°C. The JEDEC High-K board design used to derive this data was a 2 inch x 2 inch multilayer board with 1oz. internal power and ground planes and 2oz. copper traces on the top and bottom of the board.

## Recommended Operating Conditions (@T<sub>A</sub> = +25°C, unless otherwise specified.)

Symbol	Parameter	Min	Max	Unit
V <sub>IN</sub>	Input Voltage	1.7	5.25	V
I <sub>OUT</sub>	Output Current	0	300	mA
T <sub>A</sub>	Operating Ambient Temperature	-40	+85	°C

**Electrical Characteristics** (@ $T_A = +25^\circ\text{C}$ ,  $V_{IN} = V_{OUT} + 1.0\text{V}$ ,  $C_{IN} = C_{OUT} = 1.0\mu\text{F}$ ,  $I_{OUT} = 1.0\text{mA}$ , unless otherwise specified.)

Parameter	Condition		Min	Typ	Max	Units
Input Voltage	$T_A = -40^\circ\text{C}$ to $+85^\circ\text{C}$		1.7	—	5.25	V
Output Voltage Accuracy (Note 11)	$V_{OUT}(T) \geq 2.0\text{V}$ , $V_{IN} = V_{OUT}(T) + 1\text{V}$	$T_A = +25^\circ\text{C}$	$V_{OUT}(T)^*$ 0.99	$V_{OUT}(T)$	$V_{OUT}(T)^*$ 1.01	V
	$V_{OUT}(T) < 2.0\text{V}$ , $V_{IN} = V_{OUT}(T) + 1\text{V}$	$T_A = +25^\circ\text{C}$	$V_{OUT}(T)^*$ - 20mV	$V_{OUT}(T)$	$V_{OUT}(T)^*$ + 20mV	
Line Regulation ( $dV_{OUT}/dV_{IN}/V_{OUT}$ )	$V_{IN} = (V_{OUT} - I_{OUT} \cdot R_{DS(on)} + 1.0\text{V})$ to 5.25V, $I_{OUT} = 1.0\text{mA}$		—	0.02	0.1	%/V
Load Regulation	$V_{IN} = V_{OUT} - I_{OUT} \cdot R_{DS(on)} + 1.0\text{V}$ , $I_{OUT} = 1\text{mA}$ to 300mA		—	15	30	mV
Quiescent Current (Note 6)	$I_{OUT} = 0\text{mA}$		—	35	60	$\mu\text{A}$
$I_{STANDBY}$	$V_{EN} = 0\text{V}$ (Disabled)		—	0.01	1.0	$\mu\text{A}$
Output Current	—		300	—	—	mA
Fold-back Short Current (Note 7)	$V_{OUT}$ Short to Ground		—	55	—	mA
PSRR (Note 8)	$V_{IN} = (V_{OUT} + 1\text{V}) V_{DC} + 0.2\text{Vp-pAC}$ , $V_{OUT} \geq 1.8\text{V}$ , $I_{OUT} = 30\text{mA}$	$f = 1\text{kHz}$	—	75	—	dB
Output Noise Voltage (Note 8) (Note 9)	BW = 10Hz to 100kHz, $I_{OUT} = 30\text{mA}$		—	60	—	$\mu\text{Vrms}$
Dropout Voltage (Note 5)	$I_{OUT} = 300\text{mA}$ (X2-DFN1010-4 (Type B))	$V_{OUT} = 0.9\text{V}$	—	0.51	0.80	V
		$1.0\text{V} < V_{OUT} \leq 1.2\text{V}$	—	0.46	0.70	
		$1.2\text{V} < V_{OUT} \leq 1.4\text{V}$	—	0.39	0.58	
		$1.4\text{V} < V_{OUT} \leq 1.7\text{V}$	—	0.35	0.44	
		$1.7\text{V} < V_{OUT} \leq 2.1\text{V}$	—	0.30	0.39	
		$2.1\text{V} < V_{OUT} \leq 2.5\text{V}$	—	0.26	0.34	
		$2.5\text{V} < V_{OUT} \leq 3.0\text{V}$	—	0.25	0.30	
		$3.0\text{V} < V_{OUT} \leq 3.6\text{V}$	—	0.22	0.29	
	$I_{OUT} = 300\text{mA}$ (SOT25)	$V_{OUT} = 0.9\text{V}$	—	0.51	0.82	V
		$1.0\text{V} < V_{OUT} \leq 1.2\text{V}$	—	0.46	0.72	
		$1.2\text{V} < V_{OUT} \leq 1.4\text{V}$	—	0.39	0.60	
		$1.4\text{V} < V_{OUT} \leq 1.7\text{V}$	—	0.35	0.46	
		$1.7\text{V} < V_{OUT} \leq 2.1\text{V}$	—	0.30	0.41	
		$2.1\text{V} < V_{OUT} \leq 2.5\text{V}$	—	0.26	0.36	
Output Voltage Temperature Coefficient	$I_{OUT} = 30\text{mA}$ , $T_A = -40^\circ\text{C}$ to $+85^\circ\text{C}$		—	$\pm 30$	—	ppm/ $^\circ\text{C}$
	Thermal Shutdown Threshold (TSHDN)		—	+150	—	$^\circ\text{C}$
Thermal Shutdown Hysteresis (THYS)		—	—	+20	—	$^\circ\text{C}$
EN Input Low Voltage		—	0	—	0.5	V
EN Input High Voltage		—	1.3	—	5.25	V
EN Input Leakage		$V_{EN} = 0$ , $V_{IN} = 5.0\text{V}$ or $V_{EN} = 5.0\text{V}$ , $V_{IN} = 0\text{V}$	-1.0	—	+1.0	$\mu\text{A}$
On Resistance of N-Channel for Auto-Discharge (Note 10)		$V_{IN} = 4.0\text{V}$ , $V_{EN} = 0\text{V}$ (Disabled)	—	30	—	$\Omega$
Thermal Resistance Junction to Ambient ( $\theta_{JA}$ )	X2-DFN1010-4 (Type B)		—	237	—	$^\circ\text{C}/\text{W}$
	SOT25		—	179	—	
Thermal Resistance Junction to Case ( $\theta_{JC}$ )	X2-DFN1010-4 (Type B)		—	96	—	
	SOT25		—	52	—	

- Notes:
- Dropout voltage is the voltage difference between the input and the output at which the output voltage drops 2% below its nominal value.
  - Quiescent current is defined here is the difference in current between the input and the output.
  - Short circuit current is measured with  $V_{OUT}$  pulled to GND.
  - This specification is guaranteed by design.
  - To make sure lowest environment noise minimizes the influence on noise measurement.
  - AP7343 has 2 options for output, built-in discharge and non-discharge.
  - Potential multiple grades based on following output voltage accuracy.

**Typical Characteristics**

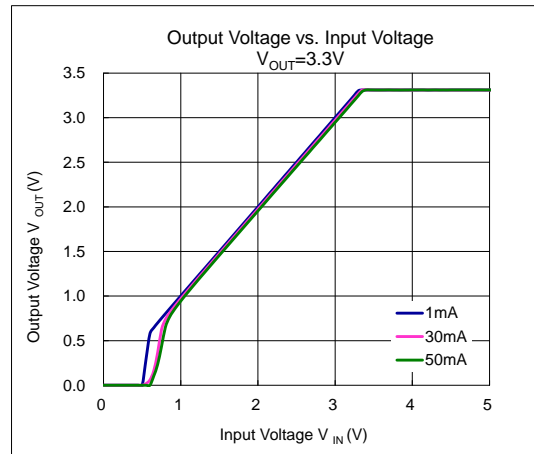
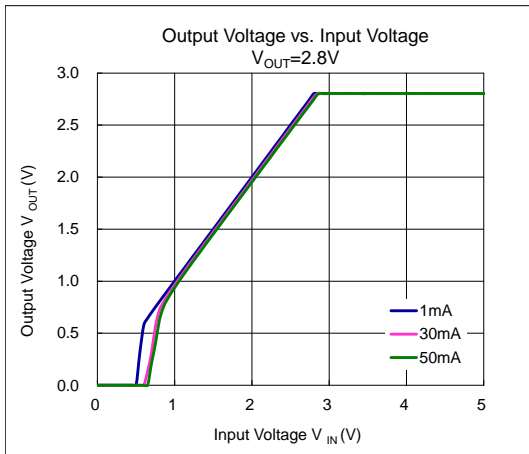
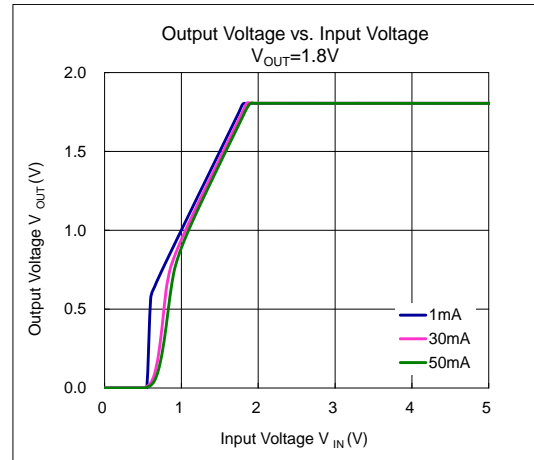
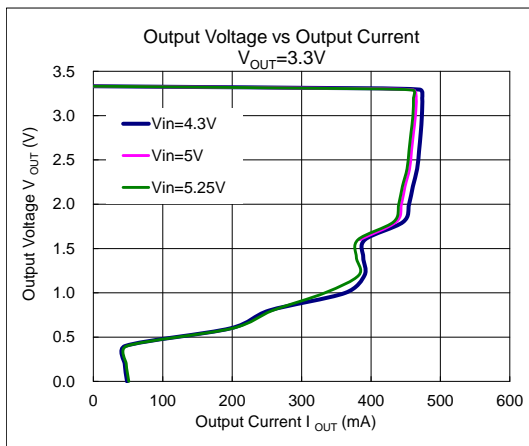
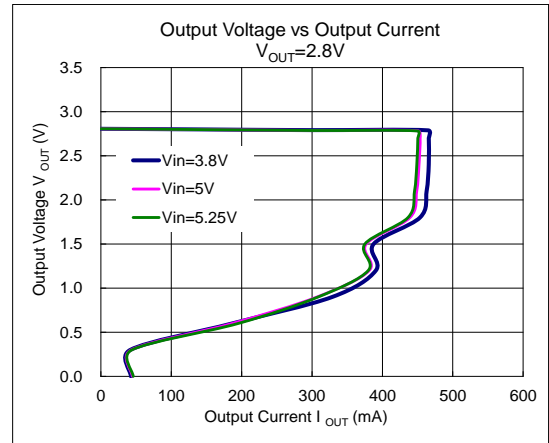
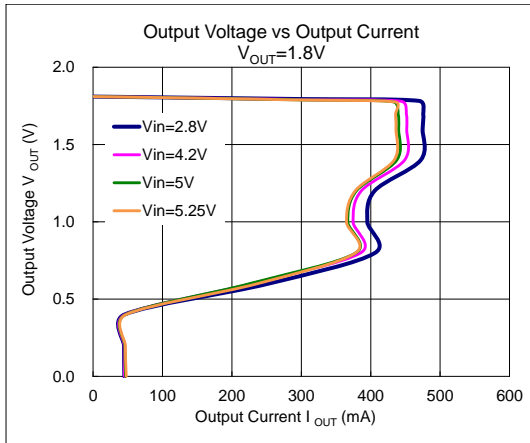

**Typical Characteristics (Cont.)**

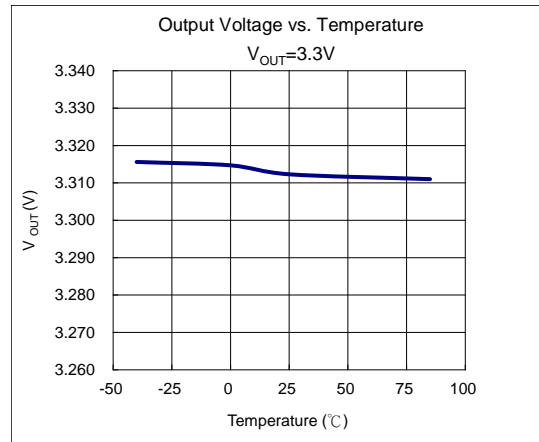
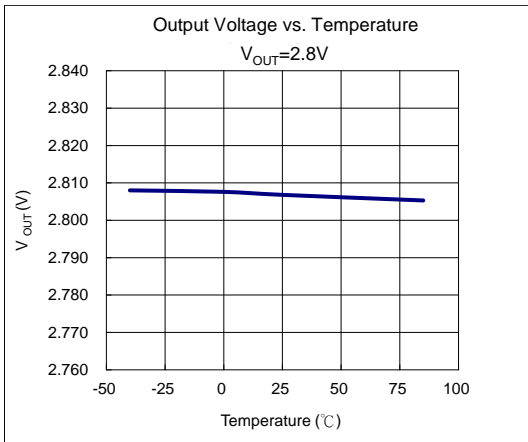
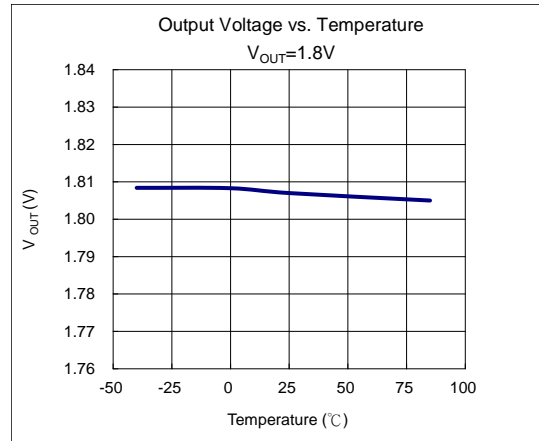
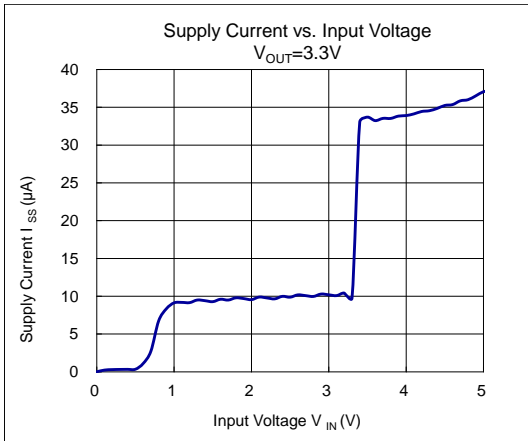
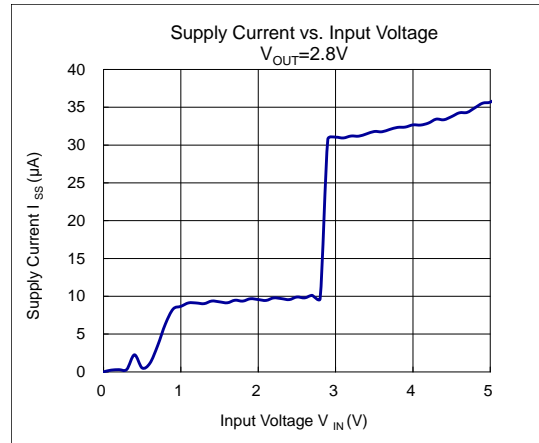
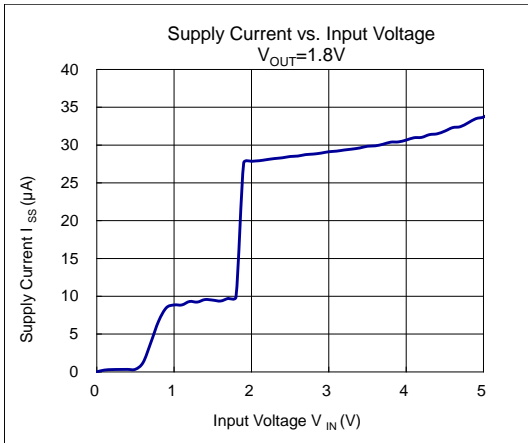

**Typical Characteristics (Cont.)**

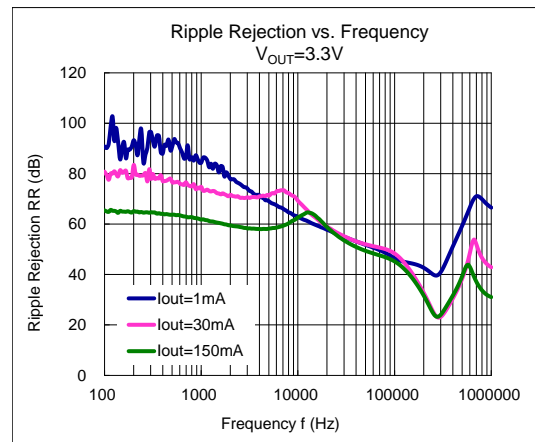
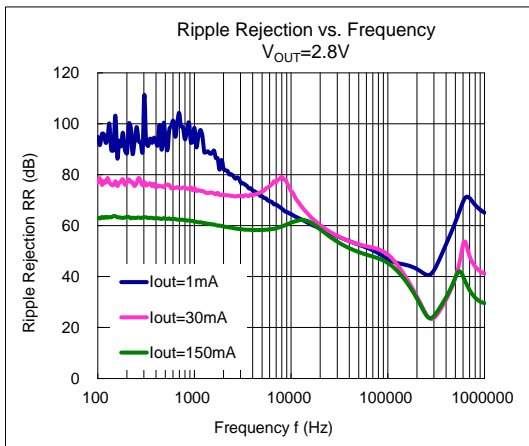
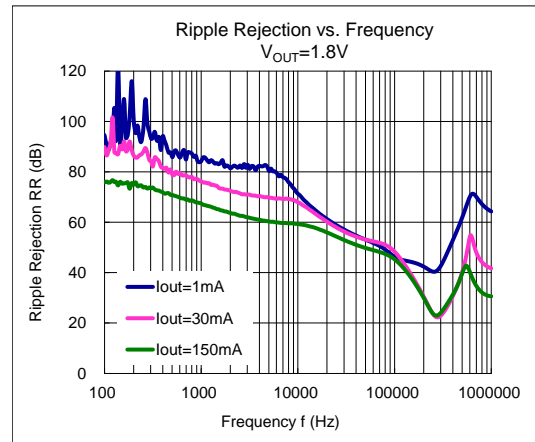
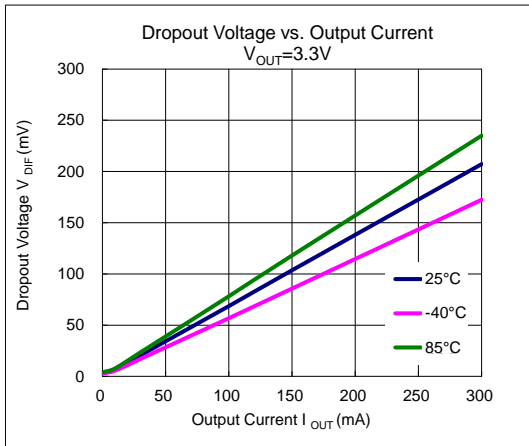
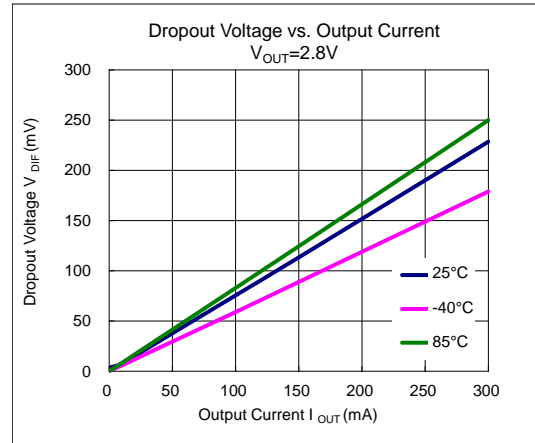
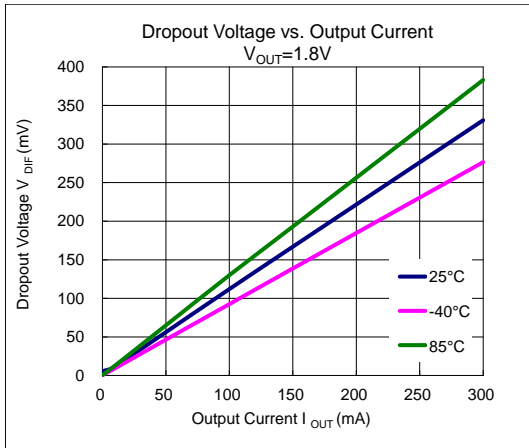

**Typical Characteristics (Cont.)**

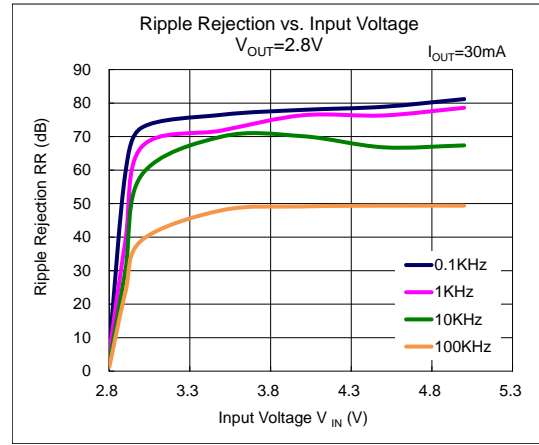
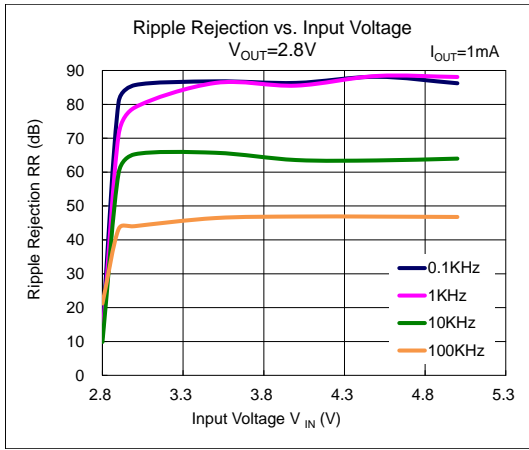

Line Transient Response Waveforms ( $I_{OUT} = 30mA$ ,  $t_R = t_F = 5\mu s$ ,  $C_{IN} = None$ ,  $C_{OUT1} = C_{OUT2} = 1\mu F$ ,  $T_A = +25^\circ C$ )

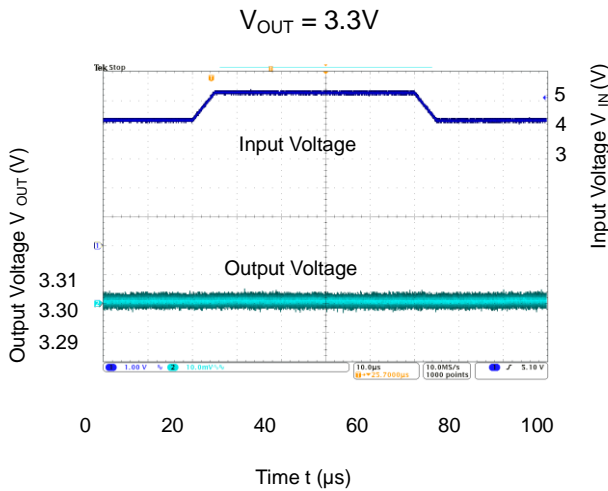
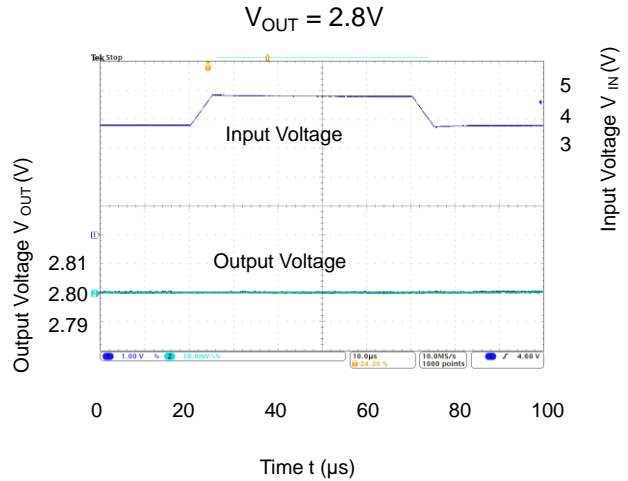
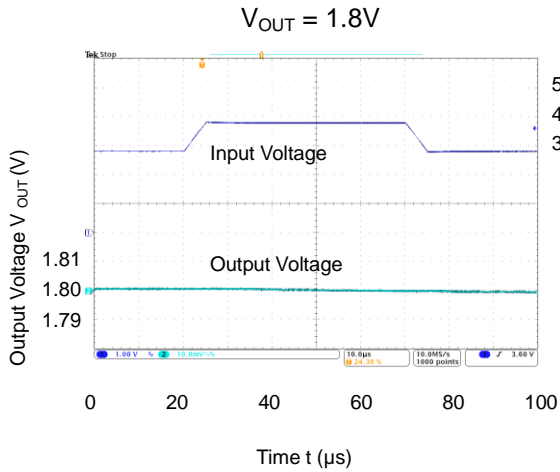

**Typical Characteristics (Cont.)**

Load Transient Response Waveforms ( $V_{IN} = V_{OUT} + 1V$ ,  $C_{IN} = 1\mu F$ ,  $T_A = +25^\circ C$ )

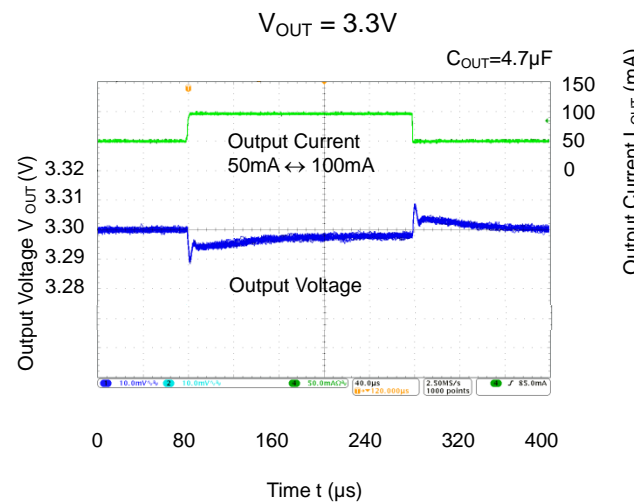
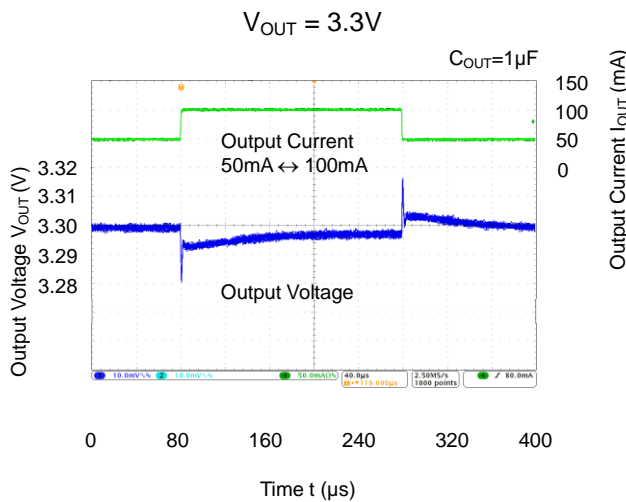
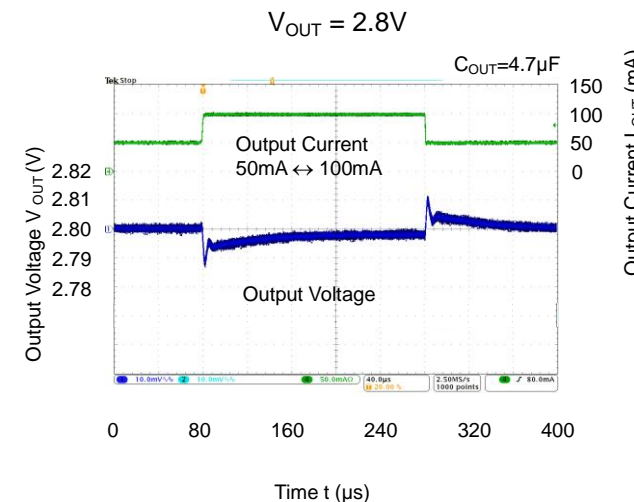
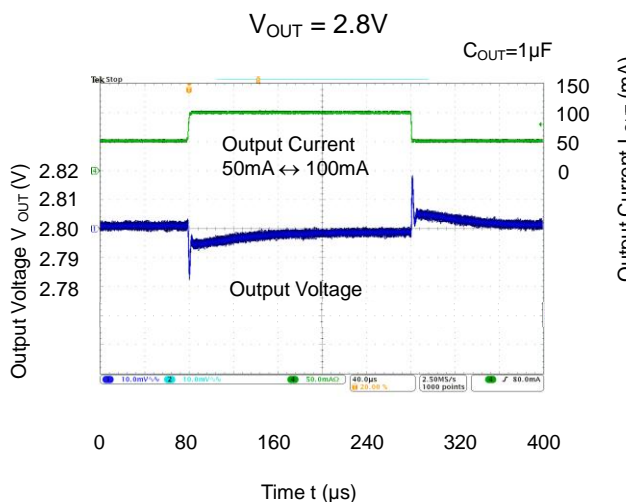
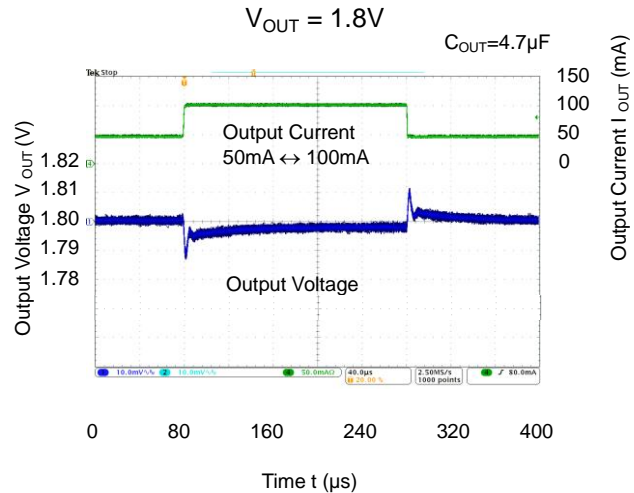
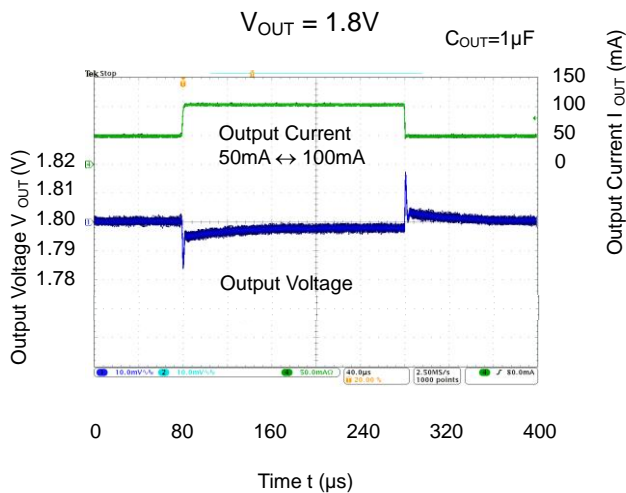



**Typical Characteristics (Cont.)**

Load Transient Response Waveforms ( $V_{IN} = V_{OUT} + 1V$ ,  $C_{IN} = 1\mu F$ ,  $T_A = +25^\circ C$ )

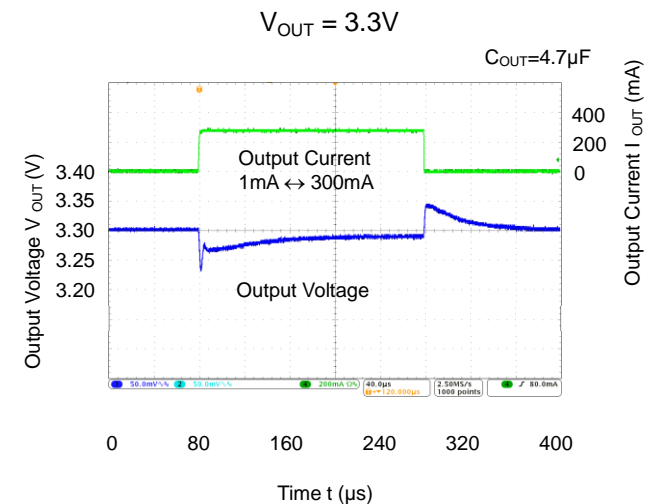
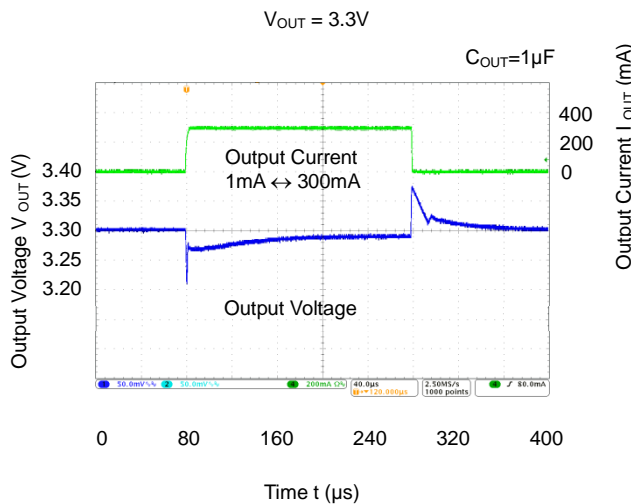
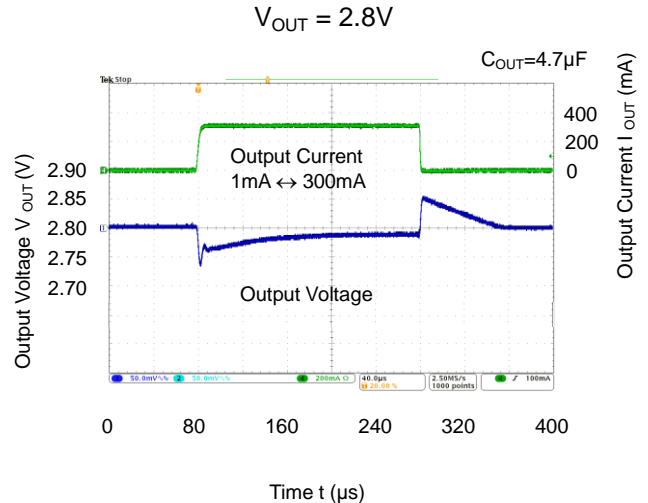
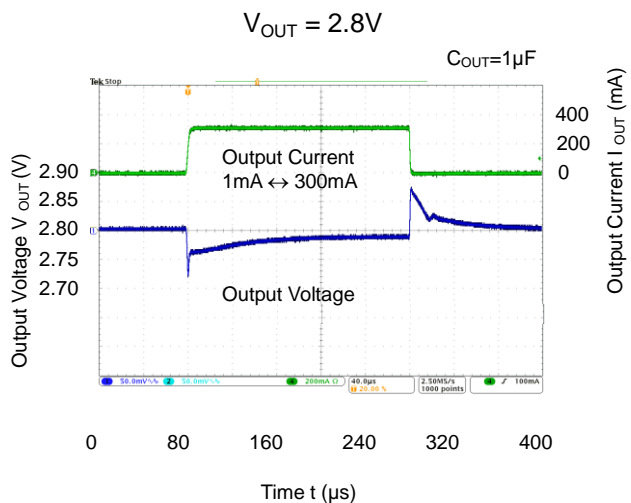
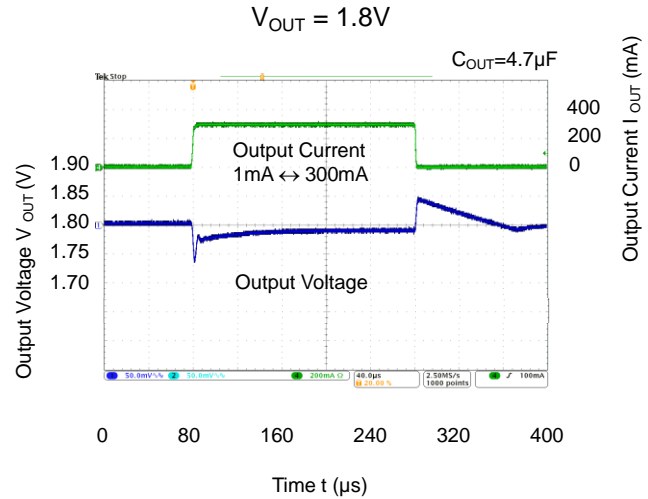
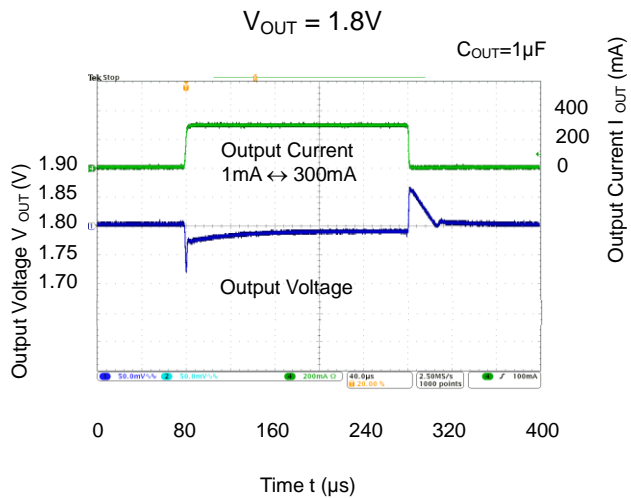

**Typical Characteristics (Cont.)**

Turn On & Off Waveforms ( $V_{IN} = V_{OUT} + 1V$ ,  $C_{IN} = 1\mu F$ ,  $C_{OUT} = 1\mu F$ ,  $T_A = +25^\circ C$ )

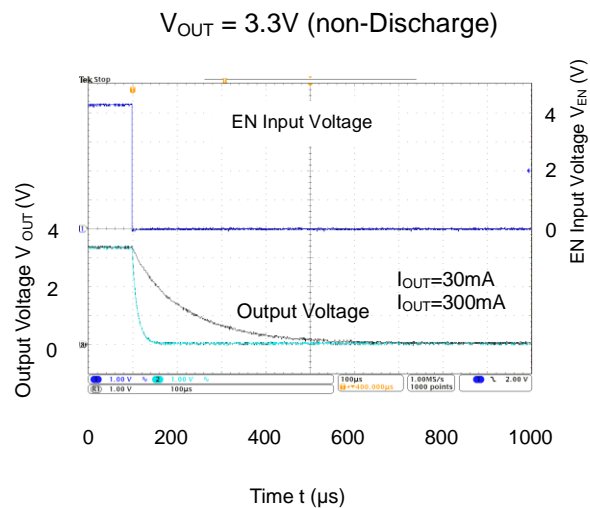
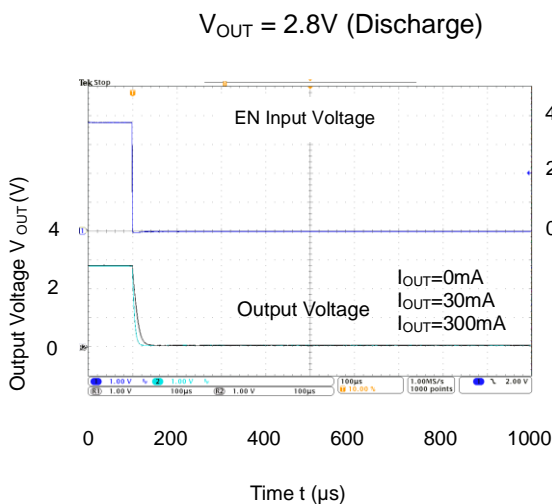
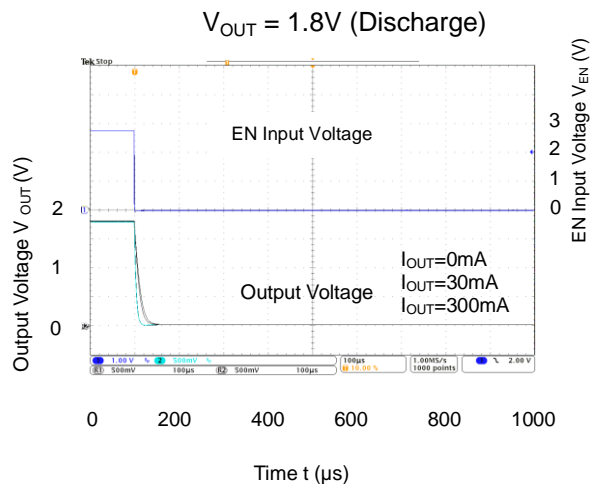
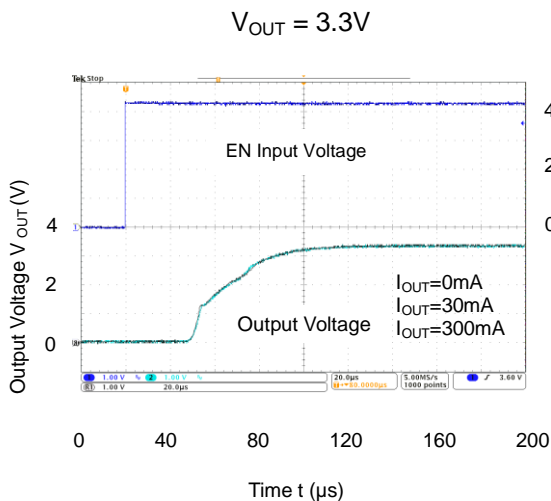
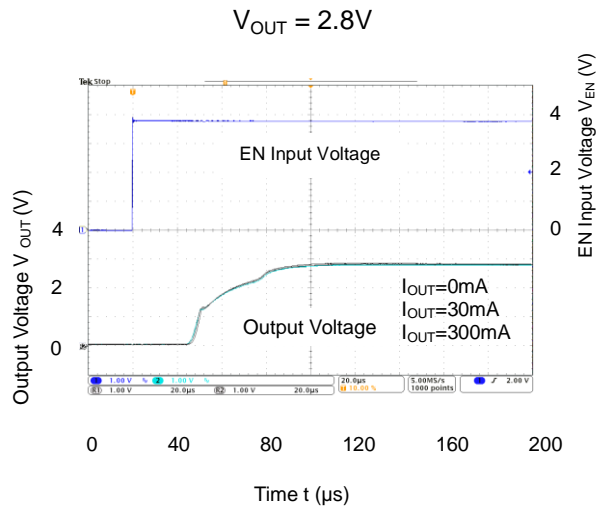
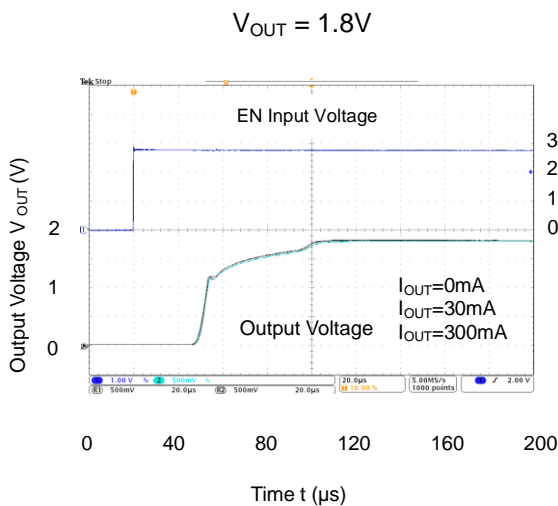

## Application Information

### Output Capacitor

An output capacitor ( $C_{OUT}$ ) is needed to improve transient response and maintain stability. The AP7343 is stable with very small ceramic output capacitors. The ESR (equivalent series resistance) and capacitance drives the selection. If the application has large load variations, it is recommended to utilize low-ESR bulk capacitors. It is recommended to place ceramic capacitors as close as possible to the load and the ground pin and care should be taken to reduce the impedance in the layout.

### Input Capacitor

To prevent the input voltage from dropping during load steps, it is recommended to utilize an input capacitor ( $C_{IN}$ ). A minimum  $0.47\mu\text{F}$  ceramic capacitor is recommended between  $V_{IN}$  and GND pins to decouple input power supply glitch. This input capacitor must be located as close as possible to the device to assure input stability and reduce noise. For PCB layout, a wide copper trace is required for both  $V_{IN}$  and GND pins.

### Enable Control

The AP7343 is turned on by setting the EN pin high, and is turned off by pulling it low. If this feature is not used, the EN pin should be tied to  $V_{IN}$  pin to keep the regulator output on at all times. To ensure proper operation, the signal source used to drive the EN pin must be able to swing above and below the specified turn-on/off voltage thresholds listed in the Electrical Characteristics section.

### Short Circuit Protection

When  $V_{OUT}$  pin is short-circuit to GND, short circuit protection will be triggered and clamp the output current to approximately 60mA. This feature protects the regulator from overcurrent and damage due to overheating.

### Layout Considerations

For good ground loop and stability, the input and output capacitors should be located close to the input, output, and ground pins of the device. The regulator ground pin should be connected to the external circuit ground to reduce voltage drop caused by trace impedance. Ground plane is generally used to reduce trace impedance. Wide trace should be used for large current paths from  $V_{IN}$  to  $V_{OUT}$ , and load circuit.

## ESR vs. Output Current

Ceramic type output capacitor is recommended for this series; however, the other output capacitors with low ESR also can be used. The relations between  $I_{OUT}$  (Output Current) and ESR of an output capacitor are shown below. The stable region is marked as the hatched area in the graph.

Measurement conditions: Frequency Band: 10Hz to 2MHz, Temperature:  $-40^{\circ}\text{C}$  to  $+85^{\circ}\text{C}$ .

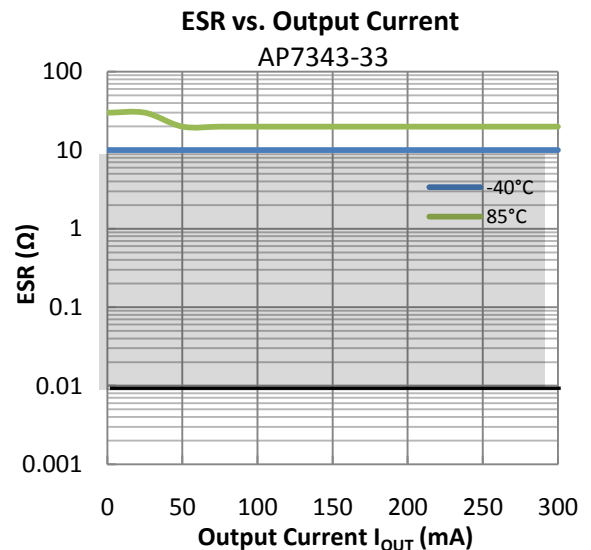
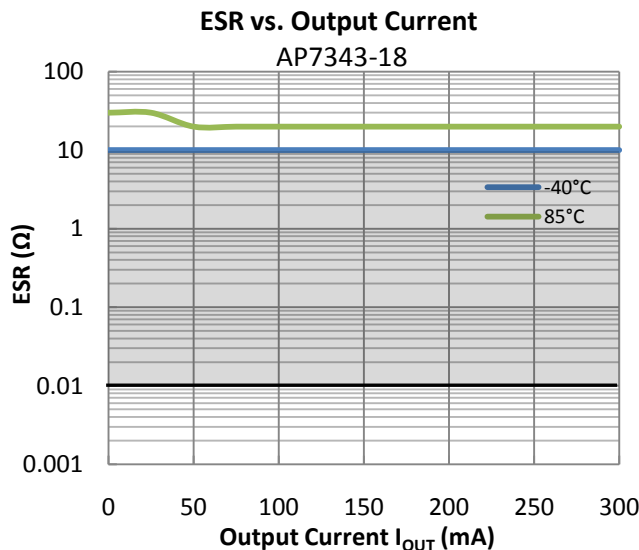

**Ordering Information** (Note 12)

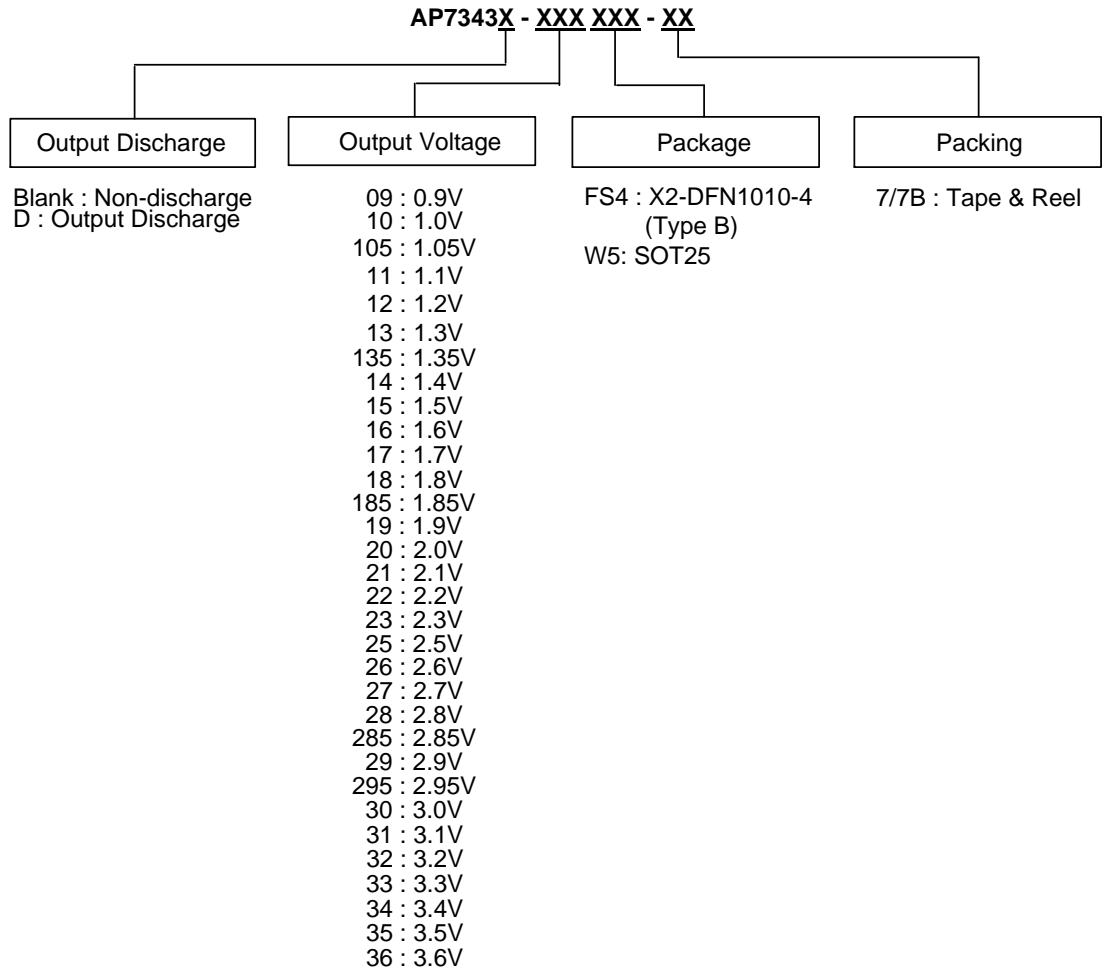

Part Number	Package Code	Packaging	7" Tape and Reel	
			Quantity	Part Number Suffix
AP7343-XXXFS4-7B	FS4	X2-DFN1010-4 (Type B)	10,000/Tape & Reel	-7B
AP7343D-XXXFS4-7B	FS4	X2-DFN1010-4 (Type B)	10,000/Tape & Reel	-7B
AP7343-XXXW5-7	W5	SOT25	3,000/Tape & Reel	-7
AP7343D-XXXW5-7	W5	SOT25	3,000/Tape & Reel	-7

Note: 12. For packaging details, go to our website at <http://www.diodes.com/products/packages.html>.

## Marking Information

(1) X2-DFN1010-4 (Type B)

(Top View)

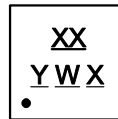

XX : Identification Code  
Y : Year : 0~9  
W : Week : A~Z : 1~26 week;  
           a~z : 27~52 week; z represents  
           52 and 53 week  
X : A~Z : Internal code

Part Number	Package	Identification Code
AP7343-09FS4-7B	X2-DFN1010-4 (Type B)	7B
AP7343-10FS4-7B	X2-DFN1010-4 (Type B)	7C
AP7343-105FS4-7B	X2-DFN1010-4 (Type B)	7D
AP7343-11FS4-7B	X2-DFN1010-4 (Type B)	7E
AP7343-12FS4-7B	X2-DFN1010-4 (Type B)	7F
AP7343-135FS4-7B	X2-DFN1010-4 (Type B)	7G
AP7343-15FS4-7B	X2-DFN1010-4 (Type B)	7H
AP7343-18FS4-7B	X2-DFN1010-4 (Type B)	7J
AP7343-185FS4-7B	X2-DFN1010-4 (Type B)	7K
AP7343-22FS4-7B	X2-DFN1010-4 (Type B)	7M
AP7343-25FS4-7B	X2-DFN1010-4 (Type B)	7N
AP7343-28FS4-7B	X2-DFN1010-4 (Type B)	7P
AP7343-285FS4-7B	X2-DFN1010-4 (Type B)	7R
AP7343-295FS4-7B	X2-DFN1010-4 (Type B)	7S
AP7343-30FS4-7B	X2-DFN1010-4 (Type B)	7T
AP7343-31FS4-7B	X2-DFN1010-4 (Type B)	7U
AP7343-32FS4-7B	X2-DFN1010-4 (Type B)	7V
AP7343-33FS4-7B	X2-DFN1010-4 (Type B)	7W
AP7343D-09FS4-7B	X2-DFN1010-4 (Type B)	8B
AP7343D-10FS4-7B	X2-DFN1010-4 (Type B)	8C
AP7343D-105FS4-7B	X2-DFN1010-4 (Type B)	8D
AP7343D-11FS4-7B	X2-DFN1010-4 (Type B)	8E
AP7343D-12FS4-7B	X2-DFN1010-4 (Type B)	8F
AP7343D-13FS4-7B	X2-DFN1010-4 (Type B)	8G
AP7343D-135FS4-7B	X2-DFN1010-4 (Type B)	8H
AP7343D-14FS4-7B	X2-DFN1010-4 (Type B)	8J
AP7343D-15FS4-7B	X2-DFN1010-4 (Type B)	8K
AP7343D-16FS4-7B	X2-DFN1010-4 (Type B)	8M
AP7343D-17FS4-7B	X2-DFN1010-4 (Type B)	8N
AP7343D-18FS4-7B	X2-DFN1010-4 (Type B)	8P
AP7343D-185FS4-7B	X2-DFN1010-4 (Type B)	8R
AP7343D-19FS4-7B	X2-DFN1010-4 (Type B)	8S
AP7343D-20FS4-7B	X2-DFN1010-4 (Type B)	8T
AP7343D-21FS4-7B	X2-DFN1010-4 (Type B)	8U
AP7343D-22FS4-7B	X2-DFN1010-4 (Type B)	8V
AP7343D-23FS4-7B	X2-DFN1010-4 (Type B)	8W
AP7343D-25FS4-7B	X2-DFN1010-4 (Type B)	8X
AP7343D-26FS4-7B	X2-DFN1010-4 (Type B)	8Y
AP7343D-27FS4-7B	X2-DFN1010-4 (Type B)	8Z
AP7343D-28FS4-7B	X2-DFN1010-4 (Type B)	6J
AP7343D-285FS4-7B	X2-DFN1010-4 (Type B)	6K
AP7343D-29FS4-7B	X2-DFN1010-4 (Type B)	6M
AP7343D-295FS4-7B	X2-DFN1010-4 (Type B)	6N
AP7343D-30FS4-7B	X2-DFN1010-4 (Type B)	6P
AP7343D-31FS4-7B	X2-DFN1010-4 (Type B)	6R
AP7343D-32FS4-7B	X2-DFN1010-4 (Type B)	6S
AP7343D-33FS4-7B	X2-DFN1010-4 (Type B)	6T
AP7343D-34FS4-7B	X2-DFN1010-4 (Type B)	6U
AP7343D-35FS4-7B	X2-DFN1010-4 (Type B)	6V
AP7343D-36FS4-7B	X2-DFN1010-4 (Type B)	6W

## Marking Information (Cont.)

### (2) SOT25

(Top View)

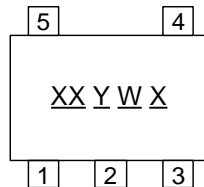

XX : Identification Code  
Y : Year 0 to 9  
W : Week : A to Z : 1 to 26 week;  
           a to z : 27 to 52 week; z represents  
           52 and 53 week  
X : Internal Code

Part Number	Package Type	Identification Code
AP7343-09W5-7	SOT25	7B
AP7343-10W5-7	SOT25	7C
AP7343-105W5-7	SOT25	7D
AP7343-11W5-7	SOT25	7E
AP7343-12W5-7	SOT25	7F
AP7343-135W5-7	SOT25	7G
AP7343-15W5-7	SOT25	7H
AP7343-18W5-7	SOT25	7J
AP7343-185W5-7	SOT25	7K
AP7343-22W5-7	SOT25	7M
AP7343-25W5-7	SOT25	7N
AP7343-28W5-7	SOT25	7P
AP7343-285W5-7	SOT25	7R
AP7343-295W5-7	SOT25	7S
AP7343-30W5-7	SOT25	7T
AP7343-31W5-7	SOT25	7U
AP7343-32W5-7	SOT25	7V
AP7343-33W5-7	SOT25	7W
AP7343D-09W5-7	SOT25	8B
AP7343D-10W5-7	SOT25	8C
AP7343D-105W5-7	SOT25	8D
AP7343D-11W5-7	SOT25	8E
AP7343D-12W5-7	SOT25	8F
AP7343D-13W5-7	SOT25	8G
AP7343D-135W5-7	SOT25	8H
AP7343D-14W5-7	SOT25	8J
AP7343D-15W5-7	SOT25	8K
AP7343D-16W5-7	SOT25	8M
AP7343D-17W5-7	SOT25	8N
AP7343D-18W5-7	SOT25	8P
AP7343D-185W5-7	SOT25	8R
AP7343D-19W5-7	SOT25	8S
AP7343D-20W5-7	SOT25	8T
AP7343D-21W5-7	SOT25	8U
AP7343D-22W5-7	SOT25	8V
AP7343D-23W5-7	SOT25	8W
AP7343D-25W5-7	SOT25	8X
AP7343D-26W5-7	SOT25	8Y
AP7343D-27W5-7	SOT25	8Z
AP7343D-28W5-7	SOT25	6J
AP7343D-285W5-7	SOT25	6K
AP7343D-29W5-7	SOT25	6M
AP7343D-295W5-7	SOT25	6N
AP7343D-30W5-7	SOT25	6P
AP7343D-31W5-7	SOT25	6R
AP7343D-32W5-7	SOT25	6S
AP7343D-33W5-7	SOT25	6T
AP7343D-34W5-7	SOT25	6U
AP7343D-35W5-7	SOT25	6V
AP7343D-36W5-7	SOT25	6W

**Package Outline Dimensions**

Please see <http://www.diodes.com/package-outlines.html> for the latest version.

(1) X2-DFN1010-4 (Type B)

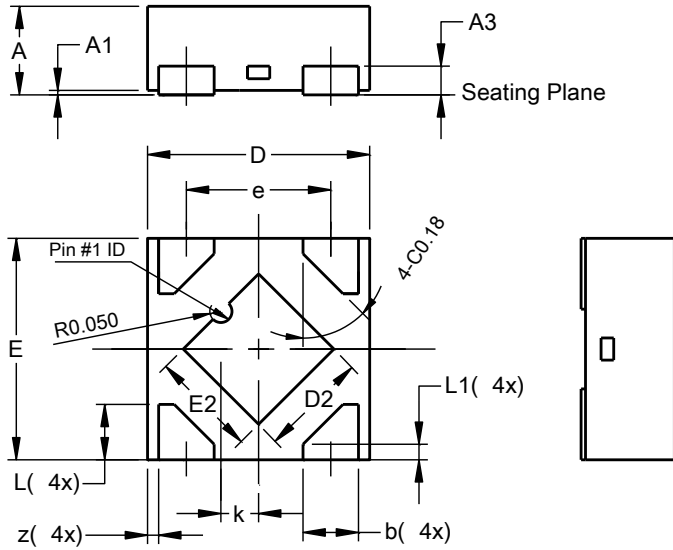

X2-DFN1010-4 (Type B)			
Dim	Min	Max	Typ
A	-	0.40	0.39
A1	0.00	0.05	0.02
A3	-	-	0.13
b	0.20	0.30	0.25
D	0.95	1.05	1.00
D2	0.43	0.53	0.48
E	0.95	1.05	1.00
E2	0.43	0.53	0.48
e	-	-	0.65
k	-	-	0.17
L	0.20	0.30	0.25
L1	0.02	0.12	0.07
z	-	-	0.050
All Dimensions in mm			

(2) SOT25

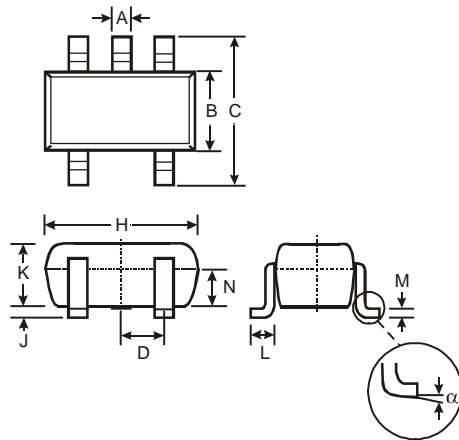

SOT25			
Dim	Min	Max	Typ
A	0.35	0.50	0.38
B	1.50	1.70	1.60
C	2.70	3.00	2.80
D	-	-	0.95
H	2.90	3.10	3.00
J	0.013	0.10	0.05
K	1.00	1.30	1.10
L	0.35	0.55	0.40
M	0.10	0.20	0.15
N	0.70	0.80	0.75
α	0°	8°	-
All Dimensions in mm			

**Suggested Pad Layout**

Please see <http://www.diodes.com/package-outlines.html> for the latest version.

(1) X2-DFN1010-4 (Type B)

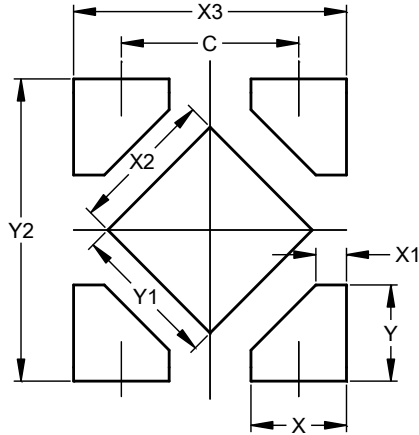

Dimensions	Value (in mm)
C	0.650
X	0.350
X1	0.112
X2	0.530
X3	1.00
Y	0.350
Y1	0.530
Y2	1.100

(2) SOT25

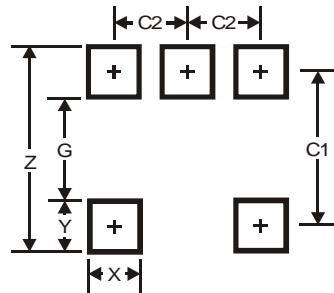

Dimensions	Value
Z	3.20
G	1.60
X	0.55
Y	0.80
C1	2.40
C2	0.95



**Tape Orientation**

For AP7343-XXXFS4-7B & AP7343D-XXXFS4-7B

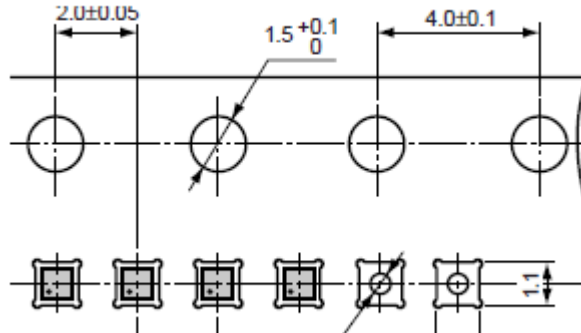

For AP7343-XXXW5-7 & AP7343D-XXXW5-7

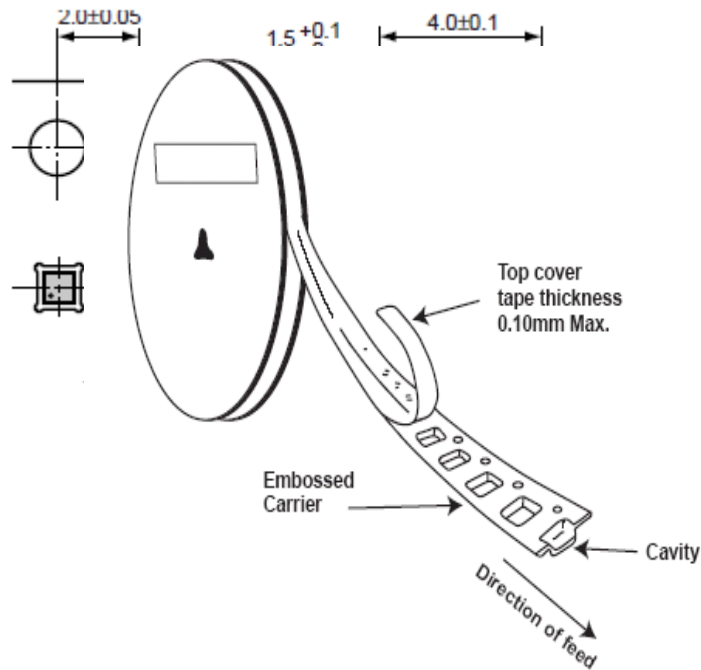
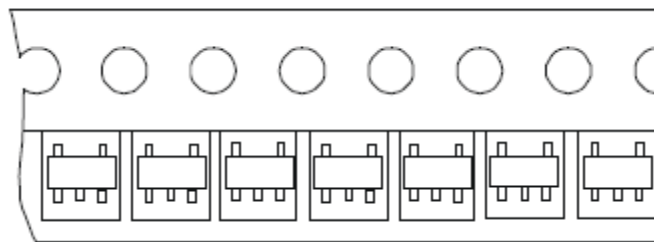

Note: 13. The taping orientation of the other package type can be found on our website at <http://www.diodes.com/datasheets/ap02007.pdf>.

**IMPORTANT NOTICE**

DIODES INCORPORATED MAKES NO WARRANTY OF ANY KIND, EXPRESS OR IMPLIED, WITH REGARDS TO THIS DOCUMENT, INCLUDING, BUT NOT LIMITED TO, THE IMPLIED WARRANTIES OF MERCHANTABILITY AND FITNESS FOR A PARTICULAR PURPOSE (AND THEIR EQUIVALENTS UNDER THE LAWS OF ANY JURISDICTION).

Diodes Incorporated and its subsidiaries reserve the right to make modifications, enhancements, improvements, corrections or other changes without further notice to this document and any product described herein. Diodes Incorporated does not assume any liability arising out of the application or use of this document or any product described herein; neither does Diodes Incorporated convey any license under its patent or trademark rights, nor the rights of others. Any Customer or user of this document or products described herein in such applications shall assume all risks of such use and will agree to hold Diodes Incorporated and all the companies whose products are represented on Diodes Incorporated website, harmless against all damages.

Diodes Incorporated does not warrant or accept any liability whatsoever in respect of any products purchased through unauthorized sales channel. Should Customers purchase or use Diodes Incorporated products for any unintended or unauthorized application, Customers shall indemnify and hold Diodes Incorporated and its representatives harmless against all claims, damages, expenses, and attorney fees arising out of, directly or indirectly, any claim of personal injury or death associated with such unintended or unauthorized application.

Products described herein may be covered by one or more United States, international or foreign patents pending. Product names and markings noted herein may also be covered by one or more United States, international or foreign trademarks.

This document is written in English but may be translated into multiple languages for reference. Only the English version of this document is the final and determinative format released by Diodes Incorporated.

**LIFE SUPPORT**

Diodes Incorporated products are specifically not authorized for use as critical components in life support devices or systems without the express written approval of the Chief Executive Officer of Diodes Incorporated. As used herein:

A. Life support devices or systems are devices or systems which:

1. are intended to implant into the body, or
2. support or sustain life and whose failure to perform when properly used in accordance with instructions for use provided in the labeling can be reasonably expected to result in significant injury to the user.

B. A critical component is any component in a life support device or system whose failure to perform can be reasonably expected to cause the failure of the life support device or to affect its safety or effectiveness.

Customers represent that they have all necessary expertise in the safety and regulatory ramifications of their life support devices or systems, and acknowledge and agree that they are solely responsible for all legal, regulatory and safety-related requirements concerning their products and any use of Diodes Incorporated products in such safety-critical, life support devices or systems, notwithstanding any devices- or systems-related information or support that may be provided by Diodes Incorporated. Further, Customers must fully indemnify Diodes Incorporated and its representatives against any damages arising out of the use of Diodes Incorporated products in such safety-critical, life support devices or systems.

Copyright © 2016, Diodes Incorporated

[www.diodes.com](http://www.diodes.com)

# Mouser Electronics

Authorized Distributor

Click to View Pricing, Inventory, Delivery & Lifecycle Information:

## Diodes Incorporated:

[AP7343-12FS4-7B](#) [AP7343-25FS4-7B](#) [AP7343D-09FS4-7B](#) [AP7343-135FS4-7B](#) [AP7343D-35FS4-7B](#) [AP7343D-27FS4-7B](#) [AP7343D-23FS4-7B](#) [AP7343D-25FS4-7B](#) [AP7343-11FS4-7B](#) [AP7343D-135FS4-7B](#) [AP7343D-16FS4-7B](#) [AP7343D-30FS4-7B](#) [AP7343D-15FS4-7B](#) [AP7343D-11FS4-7B](#) [AP7343-185FS4-7B](#) [AP7343-15FS4-7B](#) [AP7343D-31FS4-7B](#) [AP7343D-32FS4-7B](#) [AP7343D-29FS4-7B](#) [AP7343-285FS4-7B](#) [AP7343D-105FS4-7B](#) [AP7343D-17FS4-7B](#) [AP7343-105FS4-7B](#) [AP7343-28FS4-7B](#) [AP7343-295FS4-7B](#) [AP7343-18FS4-7B](#) [AP7343D-14FS4-7B](#) [AP7343D-20FS4-7B](#) [AP7343-32FS4-7B](#) [AP7343-30FS4-7B](#) [AP7343-31FS4-7B](#) [AP7343D-295FS4-7B](#) [AP7343D-10FS4-7B](#) [AP7343D-13FS4-7B](#) [AP7343D-185FS4-7B](#) [AP7343D-21FS4-7B](#) [AP7343D-28FS4-7B](#) [AP7343D-36FS4-7B](#) [AP7343D-19FS4-7B](#) [AP7343D-26FS4-7B](#) [AP7343D-18FS4-7B](#) [AP7343D-22FS4-7B](#) [AP7343D-34FS4-7B](#) [AP7343-22FS4-7B](#) [AP7343D-285FS4-7B](#) [AP7343D-12FS4-7B](#) [AP7343D-33FS4-7B](#) [AP7343-33FS4-7B](#) [AP7343-09FS4-7B](#) [AP7343-10FS4-7B](#)