



MEGATEST 5000

5000 V MEGOHMMETER

Model#: AMB-5 KVD

Owner's Manual

1.	ACCIDENT PREVENTION AND SAFETY MEASURES.....	2
1.1	DURING USE	2
1.2	AFTER USE.....	3
2	OVERVIEW.....	4
2.1	PURPOSE OF THE DEVICE	5
2.2	MEASURING PRINCIPLE	5
2.3	WHAT IS INSULATION RESISTANCE	5
2.4	POSSIBLE FIELDS OF APPLICATION	5
2.4.1	<i>Other possible fields of employment</i>	6
2.5	USE OF THE GUARD	6
2.6	NOTES ON INSULATION MEASUREMENTS.....	7
3	PREPARING THE INSTRUMENT FOR USE.....	8
3.1	INITIAL CHECKS	8
3.2	POWER SUPPLY FOR THE INSTRUMENT	8
3.3	STORAGE.....	8
4	WORKING INSTRUCTIONS.....	9
4.1	DESCRIPTION OF THE INSTRUMENT	9
4.2	DISPLAY	10
4.3	KEYBOARD.....	11
4.4	SUMMARY OF THE MEASURING MODES	12
4.4.1	<i>Factory-set configurations</i>	13
4.4.2	<i>Previously memorised configurations</i>	14
4.4.3	<i>Extemporaneous instrument configuration</i>	14
4.5	INSTRUMENT CONFIGURATION AND MEASUREMENT PERFORMANCE	15
4.5.1	<i>Measurement preparation selection</i>	15
4.5.2	<i>MAN Mode</i>	15
4.5.3	<i>AUTO Mode</i>	15
4.5.4	<i>TIMER Mode</i>	16
4.5.5	<i>PROGR Mode</i>	16
4.5.6	<i>Measurement of polarization index</i>	17
4.6	EXAMPLES OF INSULATION MEASUREMENT.....	19
4.6.1	<i>Measuring the insulation of the windings of an electrical machine</i>	19
4.6.2	<i>Measuring on a power plant</i>	20
4.6.3	<i>Checking the efficiency of an insulator</i>	20
4.6.4	<i>Estimating the insulating strength</i>	21
4.7	SAVING THE MEASUREMENTS WHICH WERE PERFORMED	22
4.8	RECALLING MEMORISED MEASUREMENTS.....	22
4.9	PRINTING OUT MEMORISED MEASUREMENTS	22
4.10	DELETING MEMORISED MEMORIES.....	23
4.11	RESTORING THE INITIAL CONFIGURATION	23
4.12	ERROR CODE DESCRIPTION	23
4.13	USE OF THE SERIAL PORT.....	24
4.13.1	<i>Reading and downloading the results of the measurements on a computer</i>	24
5	MAINTENANCE.....	25
5.1	REPLACING THE BATTERIES.....	25
5.2	CLEANING THE INSTRUMENT	25
6	TECHNICAL SPECIFICATIONS.....	26
6.1	TECHNICAL FEATURES	26
6.1.1	<i>Measuring the insulation</i>	26
6.1.2	<i>Current which can be delivered</i>	26
6.1.3	<i>Voltage measurement</i>	26
6.1.4	<i>Safety</i>	26
6.2	GENERAL FEATURES	27
6.2.1	<i>Electric features</i>	27
6.2.2	<i>Safety</i>	27
6.2.3	<i>Mechanical features</i>	27
6.2.4	<i>Power supply</i>	27
6.2.5	<i>Display</i>	27
6.3	AMBIENT CONDITIONS	27
6.3.1	<i>Ambient conditions of use</i>	27
6.3.2	<i>EMC</i>	27
6.4	STANDARD EQUIPMENT.....	28
6.5	REPLACEMENT PARTS	28
7	WARRANTY CONDITIONS.....	29

1. Accident prevention and safety measures

Please read and understand these instructions BEFORE using the AMB-5KV-D. This instrument can generate dangerously high voltages. Only specialised personnel, well trained about electricity and its effects must use it.

When testing, the following is important:

- DO NOT TAKE MEASUREMENTS IN AN EXPLOSIVE ATMOSPHERE. i.e. GAS, FUELS OR DUST.
- Do not take measurements in wet environments
- Do not touch exposed metal parts; i.e. alligator clips, ends of test leads, circuits, etc., while taking measurements
- Prevent any accidental contact of yourself or others with the measuring voltage.
- Make sure the test voltage does not damage any component unable to withstand it.

The following symbols have been used in this manual:



Warning: comply with the instructions in the manual. Any improper use could damage the instrument, the equipment being tested or cause personnel injury.



Danger High Voltage.



Instrument with double insulation.

1.1 During use

Following are two general guidelines for setting up the tests. These must be integrated from time to time with a detailed analysis depending on the actual circumstances.

While measuring on equipment:

- Seal off the testing area and do not allow other people to approach it. If necessary, put up a sign.
- Have enough room available, plus properly insulated tables or supports.
- Take note of which parts could be live should there be defective insulation.
- Keep the area and the measuring cables clean from dust, oil or other foreign matter.
- On a routine basis, check for any abrasion or breakage on the measuring cables.
- Never exceed the maximum testing voltage for which the tested device was built and/or rated.

When measuring insulation:

- Cut power off from the installation before preparing for the tests.
- Seal off the testing area and do not allow other people to approach it throughout the duration of the tests.
- Seal off the installation being tested, disconnecting those branches of it which are not involved in the test.
- When measuring a section, make sure the test leads are at least 1 " (25 mm) apart in order to avoid discharges or unwanted coupling.
- Isolate areas not involved, so unwanted voltages do not reach them.
- Take note of which parts could be live should there be defective insulation.
- Never exceed the maximum insulation voltage the installation was built for.
- Disconnect from the installation any equipment (transformers, bells, intercom systems, antenna systems, pumps, timers, lights...) which might be damaged by the measuring or might make it less reliable.

WARNING



Danger due to capacitance. Measuring over a very large installation or on condensers can lead to a dangerous accumulation of power. Always wait for the voltage to go back to zero before disconnecting the instrument.

1.2 After use

- Once measuring has been completed, press the OFF key to turn the instrument off.
- If you expect not to use the instrument for a long period of time, take the batteries out.

2 Overview

Thank you for purchasing one of our instruments, we are a leading company in the field of electrical measuring equipment.

Amprobe has been in the marketplace for over 50 years, and intends to satisfy our customers' requirements by providing increasingly reliable and innovative products.

The AMB-5KV-D "MEGATEST 5000" is for demanding and professional customers who are looking for increasingly accurate INSULATION measurements.

It provides flexible measuring, easy programming and accuracy. It can measure up to 5000V while keeping control of every factor involved (insulation resistance, voltage and measuring time).

This instrument has been made according to the strictest rules on safety, using top quality material and technical methods.

No effort has been spared to create a product that can adapt to changing standards and regulations in the field of insulation measurement. That is why this instrument will be in the forefront for years to come.

This manual contains all the information needed to use the instrument correctly. It also points out the dangers due to its improper use, specifying the precautions to be taken in order to ensure the safety of the user, the instrument and the equipment being tested.

2.1 Purpose of the device

This instrument can be used to measure the insulation of installations, equipment, insulating material and so on.

Testing must be performed with no other voltage present, and after having disconnected the parts not being measured or which are unable to withstand the testing voltage.

This instrument is also able to measure the voltage present before the test, to display it and to inhibit starting up of the measurement in case the tested element should be live.

The pre-set measures are, in most cases, sufficient for using the instrument without any additional programming, employing the settings that were prepared at the factory.

2.2 Measuring principle

The instrument applies the requested voltage to the object being tested (material or equipment or installation), measures the circulating current and calculates the relevant insulation resistance.

While measuring, the instrument simultaneously detects and displays the resistance, making it possible to calculate its variation through time.

In certain situations (e.g. very large electrical installations or measures on condensers), there can be a stray capacity parallel to the resistance to be measured. This stray capacity is due to the presence of conductors running next to each other, and can sometimes be quite high. In such a case, the value of the resistance displayed can start out from a very low value and reach - in no short time - the real value of the insulation resistance.

In this case, therefore, the measurement is deemed to have been completed only when the displayed resistance value stabilises at less than a certain tolerance (normally 10%).

2.3 What is insulation resistance

We are used to thinking of insulation as a total inhibition of the passage of electrical current. This approximation is valid in most cases.

However, when we have to measure an insulation resistance, this approximation no longer holds true: we can imagine an inhibition that is not total, but simply very great.

Insulation is known to depend on the physical features of the material involved and on its dimension, and from an electrical point of view appears as a resistance, of course of a very high value. The higher the resistance the better the insulation.

Every kind of material has its maximum permissible voltage, depending on its thickness.

When this value is exceeded, the insulation may be perforated (discharge). This voltage value is called insulating strength, and its value is always related to the thickness of the material. When measuring insulation, one must never exceed the maximum permissible voltage (insulating strength x thickness of the material) since it can lead to deterioration of the material (perforation).

2.4 Possible fields of application

This instrument is most frequently used to make sure the insulation of electrical installations or equipment complies with the relevant regulations.

Measurements taken in the "PROGR" mode make it possible to increase the voltage slowly. This way the efficiency of an insulator can be checked out, the insulation resistance should stay more or less the same even when the voltage is increased. Should the resistance diminish as the voltage is increased, this will mean that the insulator is not a good quality one. Continuing the test might lead to an electric discharge and the perforation of the material.

When the meter is in its "TIMER" mode, set a duration of 10' to determine the efficiency of an insulator at a certain voltage. During the test, insulation resistance may diminish, remain steady or increase. Diminishing resistance means insulation is not good. On the contrary, the more the resistance increases the better the insulation.

This instrument can also be used in a laboratory, and without regard for legal regulations, in order to establish the efficiency of electronic equipment, installations or boards. This kind of use, however, requires further technical skills so as not to damage the device being tested.

2.4.1 Other possible fields of employment

In the field of automobiles, this instrument can be used to check the efficiency of the battery ignition, spark plug cables or spark plugs without having to dismantle parts in difficult locations.

Sparking promptness measurement in heating plants: a spark is generated in order to start combustion in gas and Diesel fuel systems. As time passes, the spark generator - just like the spark plug in a car - loses its efficiency and spark generation becomes increasingly difficult.

A diagnosis can be performed by measuring the insulation of the electrode that launches the spark. If insulation is poor, then it will be necessary to replace the electrode. If the insulation is good, then it will be necessary to check the generator creating it.

Measuring insulation efficiency for manufacturers of transformers or electric motors. The quality of the insulation can be monitored in order to take countermeasures in case of deterioration, before the quality goes below the acceptable level.

2.5 Use of the guard

In certain cases, surface currents may falsify the measurement. Application of a voltage to an insulator that you want to measure can create two different currents: one flowing inside the specimen, the other moving across its surface. They are parallel. If you want to measure only the resistance due to the current flowing inside the specimen (which is the meaningful resistance), you will have to use another wire to absorb the surface current (see figure).

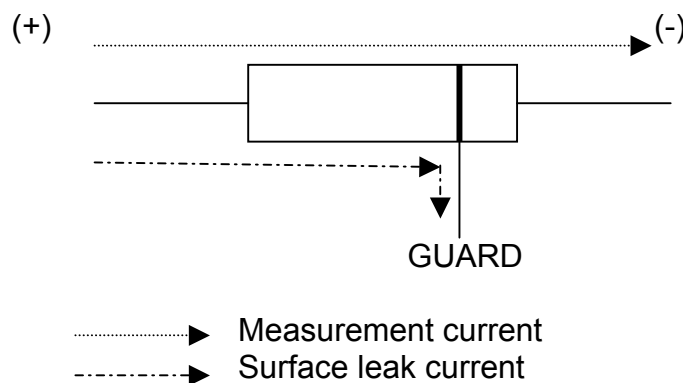

Since the voltage between the GUARD and (-) is very low, only those currents indicated above will circulate.

2.6 Notes on insulation measurements

Measurement of such a high resistance as insulation resistance is very critical, since the currents involved are minute, even lower than those circulating inside our nervous system. When performing measurements, in order to avoid making mistakes take the following precautions:

- Keep the measuring cables suspended in the air, or at most resting on one point only.
- The area surrounding the measuring equipment and the equipment being tested must be free of any object.
- Nobody must circulate near the cables or the resistance being measured.
- The operator must not move and, especially, must not move his/her arms.

These precautions are especially important when measuring resistances higher than $50\text{G}\Omega$.

Such precautions are required because any kind of movement leads to capacity variations that introduce themselves parallel to the resistance being measured. Each capacity variation implies a variation of the electrical charge; if the capacities are very small, then the relevant currents will interfere with the equally small ones circulating in the test specimen.

We advise you always to use the Guard terminal.

Even the presence of air currents can affect the results of the measurement.

The diagram below shows the stray resistance due to air conduction and the stray capacitance, S_c , present between the operator and the measuring circuit.

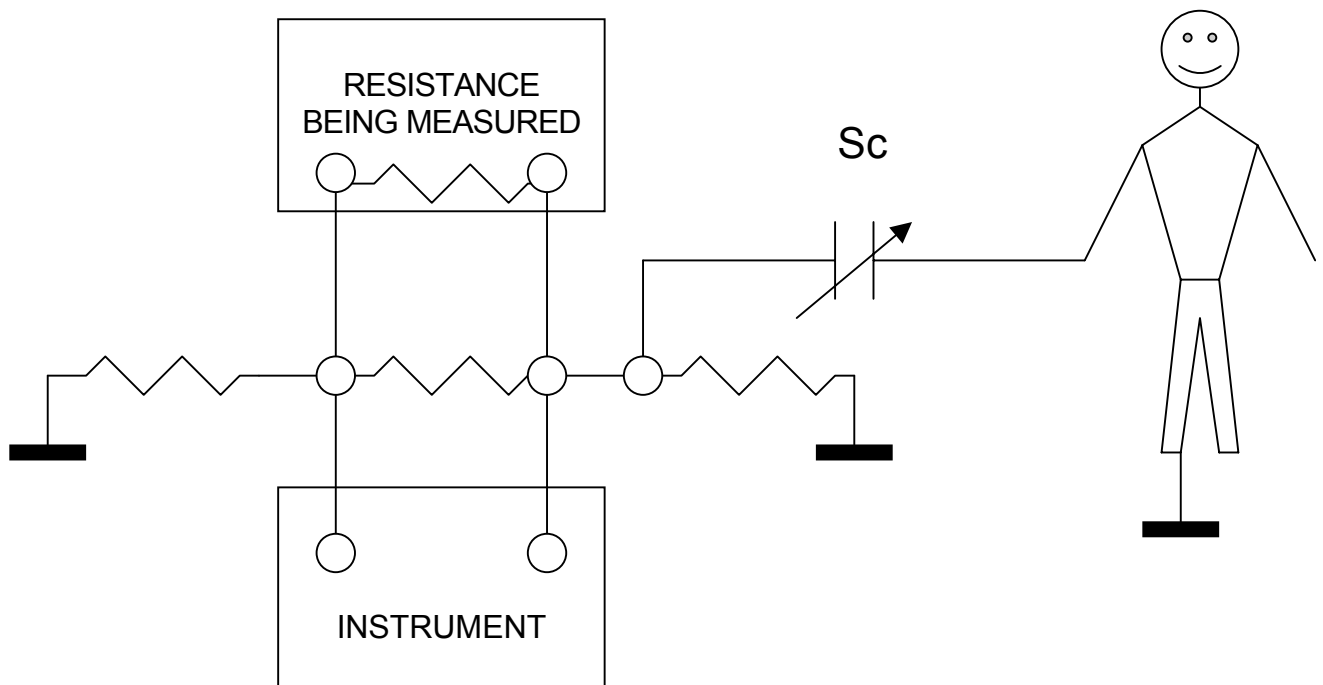

3 Preparing the instrument for use

3.1 Initial checks

Before being shipped, the instrument is checked from an electrical and a mechanical point of view.

Every precaution has been taken so the instrument can be delivered without damage.

However the user is advised to look the instrument over quickly in order to check for any damage during shipment. In case of any fault, contact the forwarding agent at once.

We also suggest making sure that the package contains every part listed under heading 6.4. In case of any discrepancy, contact the dealer.

Should it be necessary to return the instrument, please follow the instructions under the heading 7.

3.2 Power supply for the instrument

The instrument is fed by 4 each, 1.5 volt, "D" size alkaline batteries (not included)

Endurance with new batteries is as follows:

250	measurements	$V = 5000\text{ V}$	$R_x = 5\text{ M}\Omega$ (minimum)	$t = 1\text{ min.}$
450	measurements	$V = 500\text{ V}$	$R_x = 500\text{ k}\Omega$ (minimum)	$t = 1\text{ min.}$

Before measuring, make sure that the "low battery" indicator is not lit (chap. 4.2, symbol 4).

When the "low battery" indicator is lit, measurements can still be performed, but with very low resistance, it might not be possible to reach the rated voltage, and the measurement would not be valid.

3.3 Storage

If the instrument has been kept in a cold environment and the measurement must be performed in a warm place, the sharp change in temperature would make humidity condense and this would falsify the measurement.

In this case, 15 min. must be allowed for the instrument to stabilise its temperature and allow the condensation to evaporate.

4 Working instructions

4.1 Description of the instrument

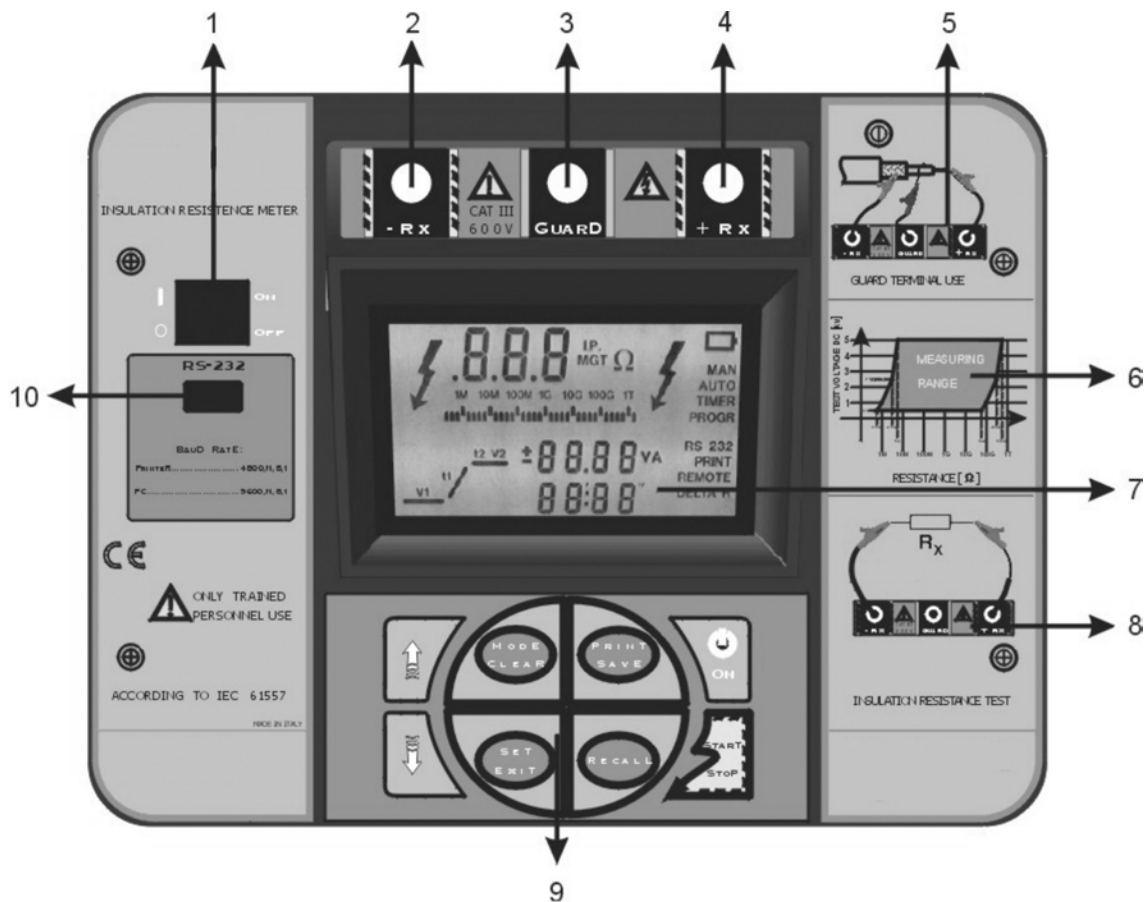

Legend:

1. Instrument ON/OFF switch.
2. Negative high voltage jack.
3. GUARD jack.
4. Positive high voltage jack.
5. An example of measurement connection using the GUARD.
6. Measuring range graph.
7. Display.
8. An example of measurement connection without using the GUARD.
9. Keyboard.
10. Serial port connector RS 232.

Note: On the front of the instrument, under the handle, there is a “purge” knob. This knob can be opened to vent the case to assist in the opening of the case following a high altitude flight.

4.2 Display

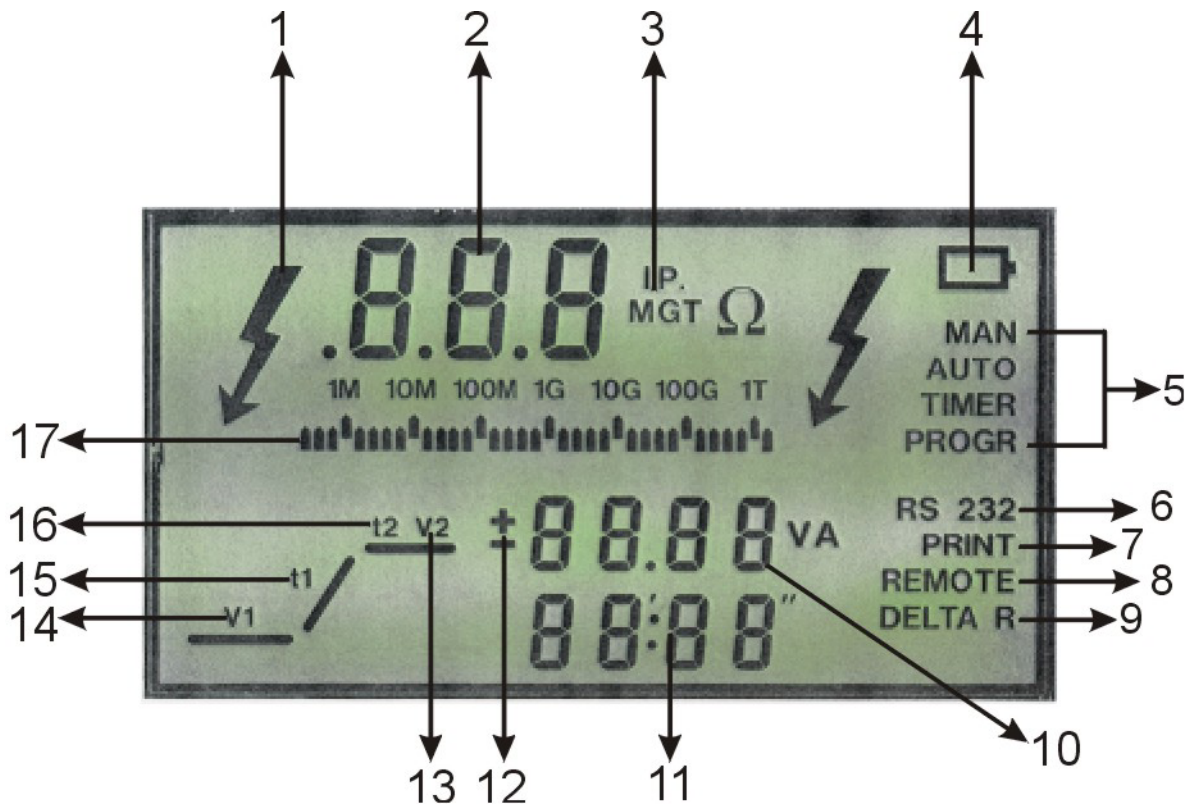

Legend:

1. "Measuring underway" indicators. When flashing: voltage delivery; when fixed ON: circuit discharge.
2. "Measured value" indicator or indication of the current parameter memory number.
3. Unit of measure.
4. "Low Battery" indicator.
5. "Current measuring mode" indicator.
6. "Current RS 232 connection" indicator.
7. "Printing underway" indicator.
8. Remote control performance indicator.
9. "AUTO measure mode" indicator (lit during measuring).
10. Voltage indicator:
 - Before measuring, this displays the voltage at the test leads.
 - While measuring, the delivered voltage is displayed.
11. Measuring time indicator in TIMER or PROGR. mode.
12. Indicator of the polarity of the voltage being read.
13. This indicates the voltage parameter V2.
14. This indicates the voltage parameter V1.
15. This indicates the time parameter T1.
16. This indicates the time parameter T2.
17. Bar graph.

4.3 Keyboard

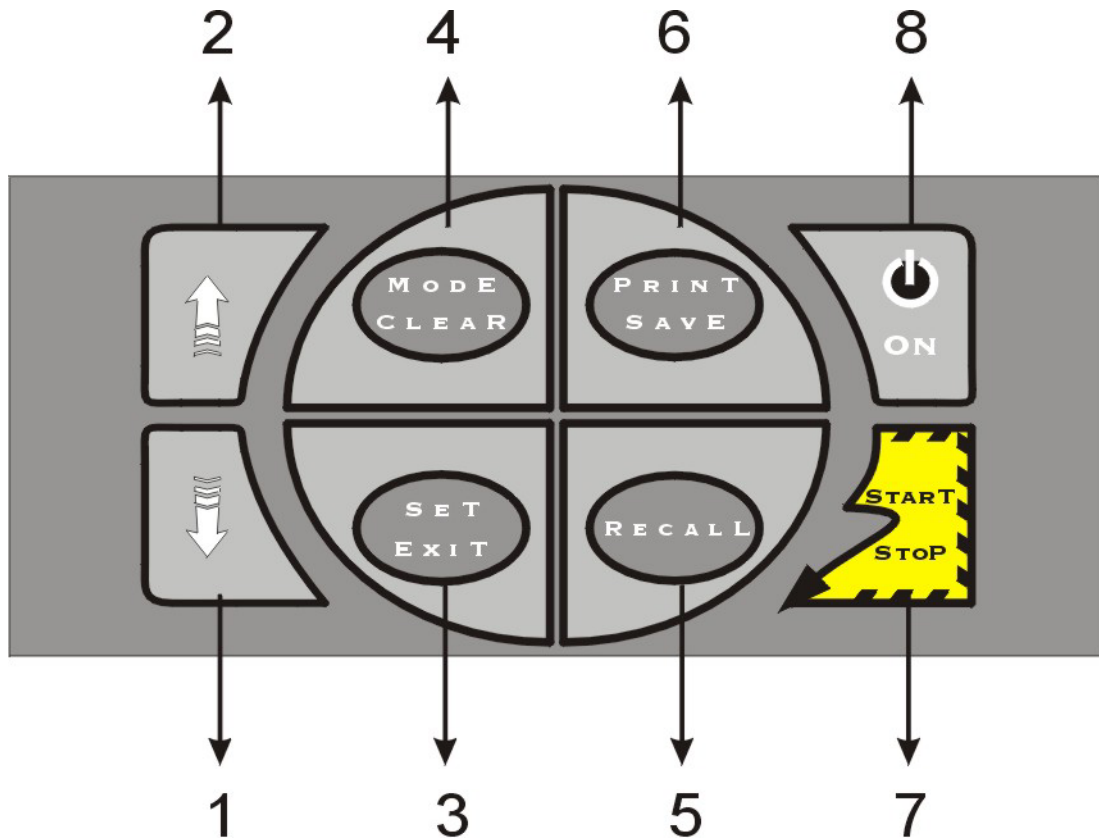

Legend:

- | | | |
|---|---|---|
| 1. Decrease key | } | This modifies the voltage or time setting. |
| 2. Increase key | | This displays the locations of the measurement models.
This displays the saved performed measurements. |
| 3. Confirmation or end of current operation. | | |
| 4. Choosing the mode (MAN / AUTO / TIMER / PROGR) or deletion procedure. | | |
| 5. Recalling stored measurements. | | |
| 6. Saving the measurement parameters, the measurements that were performed and printing out the measurements in the memory (from the displayed number to the last one). | | |
| 7. Starting up or stopping the measurement. | | |
| 8. Turning the instrument on after automatic turn-off. | | |

4.4 Summary of the measuring modes

The instrument was designed for simple programming, so as to cut down the time needed to prepare measuring.

The instrument is equipped with 25 memory locations (parameters – **P**) for storing the various ways of measuring:

Configuration	Factory setting	Modifiable
P01 - P19	Yes	yes
P20 - P25	Yes	no

Each configuration can be reached both by the increase and by the diminish key, as these work in a circular fashion: decreasing from P01 leads to P25, increasing from P25 leads to P01. This makes it possible to reach the location of interest as soon as possible.

The purpose of the pre-set configurations is to allow performance of measures without wasting time in setting up.

The purpose of the non-modifiable configurations is that of making the most common insulation measurement types constantly available.

Description of the measuring parameters

- Voltage V2: Final voltage value wanted for test performance.
- Time T2: Duration time for voltage V2.
- Voltage V1: Starting voltage during measuring (only in PROGR mode).
- Time T1: The time for the output voltage to rise from the voltage value V1 to the value V2 (only in PROGR mode).

This instrument is designed for use in a simple and intuitive manner, and provides the following possibilities:

- Direct use of the factory-set configurations for the most frequent cases.
- Direct use of previously set configurations.
- Extemporaneous configurations when the measurement is not included among those already present.

4.4.1 Factory-set configurations

Following are the keyboard sequences for obtaining the configurations, with the instrument at rest, starting from programme P01

P n.	Keyboard sequence	Parameters	Kind of test
P25	once the Diminish key, twice the Start key	500 1' (minute)	Timer
P24	twice the Diminish key, twice the Start key	1000 1' (minute)	Timer
P23	3 times the Diminish key, twice the Start key	2500 1' (minute)	Timer
P22	4 times the Diminish key, twice the Start key	5000 1' (minute)	Timer
P21	5 times the Diminish key, twice the Start key	5000 2' (minutes)	Timer
P20	6 times the Diminish key, twice the Start key	2500 10' (minutes)	Timer
P5-19	N times the Increase key, twice the Start key	500	Manual
P04	3 times the Increase key, twice the Start key	5000	Manual
P03	twice the Increase key, twice the Start key	2500	Manual
P02	once the Increase key, twice the Start key	1000	Manual
P01	Twice the Start key	500	Manual

4.4.2 Previously memorised configurations

When performing the same measurements on the same kind of equipment, a measuring configuration can be memorised for each usual situation, for example:

- P01 Measuring on A-type product.
- P02 Measuring on B-type product.
- P03 Measuring on C-type product.

The measuring configurations can also be divided up into groups used by different operators. E.g.:

- P01 - P05 Measurements usually performed by operator 1
- P06 - P10 Measurements usually performed by operator 2
- P11 - P15 Measurements usually performed by operator 3

In each case, all that is required is for the operator to use the arrow keys to go to the desired configuration and then to press Start to begin measuring.

4.4.3 Extemporaneous instrument configuration

Select a configuration and modify it as described under Section 4.5, *Instrument Configuration and Measurement Performance*, then use the Start key to run it. If the modified configuration is not saved, it will stay active only until a new selection is made or the instrument is turned off.

4.5 Instrument configuration and measurement performance

Following is a description of the parameters and way the values are set.

4.5.1 Measurement preparation selection

To prepare the measurement, press the increase or decrease key to run through the memories until reaching the location you intend to introduce the configuration into.



NOTICE

Memorisation is possible only from cell P01 to cell P19.

4.5.2 MAN Mode

KEY OPERATION

MAN

- ↓ ↑ Reach the memory cell you are interested in.
- ModE** Press the MODE key repeatedly to display the MAN measuring mode.
- SeT** The V2 parameter indicator is flashing.
- ↓ ↑ Set the V2 voltage value you want (testing voltage). The top secondary display (item 10 par. 4.2) will show the value you are setting.
- SeT** Exit the programming phase. The flashing measuring mode advises you that you can save the settings.
- SavE** Saving the parameters in the location first selected (if requested).
- StarT** “Go?” prompt displayed, **PRESS START** again and HOLD DOWN UNTIL READING STABILISES.

4.5.3 AUTO Mode

KEY OPERATION

AUTO

- ↓ ↑ Reach the memory cell you are interested in.
- ModE** Press the MODE key repeatedly to display the AUTO measuring mode.
- SeT** The V2 parameter indicator is flashing.
- ↓ ↑ Set the V2 voltage value you want (testing voltage). The top secondary display (item 10 par. 4.2) will show the value you are setting.
- SeT** Exit the programming phase. The flashing measuring mode advises you that you can save the settings.
- SavE** Saving the parameters in the location first selected (if requested).
- StarT** “Go ?” prompt displayed, **PRESS START** again to start measuring.

4.5.4 TIMER Mode

KEY OPERATION

TIMER

- ↓ ↑ Reach the memory cell you are interested in.
- ModE** Press the MODE key repeatedly to display the TIMER measuring mode.
- SeT** The V2 parameter indicator is flashing.
- ↓ ↑ Set the V2 voltage value you want (testing voltage). The top secondary (item 10 par. 4.2) will display the value you are setting.
- SeT** The T2 parameter indicator is flashing.
- ↓ ↑ Set the T2 time value (duration of the measurement). The bottom secondary display (item 11 par. 4.2) will show the value you are setting. The shortest time that can be set is 15" (seconds).
- SeT** Exit the programming phase. The flashing measuring mode advises you that you can save the settings.
- SavE** Saving the parameters in the location first selected (if requested).
- StarT** "Go ?" prompt displayed, **PRESS START** again to start measuring.

4.5.5 PROGR Mode

KEY OPERATION

PROGR

- ↓ ↑ Reach the memory cell you are interested in.
- ModE** Press the MODE key repeatedly to display the PROGR measuring mode.
- SeT** The V2 parameter indicator is flashing.
- ↓ ↑ Set the V2 voltage value you want (testing voltage). The top secondary display (item 10 par. 4.2) will show the value you are setting.
- SeT** The T2 parameter indicator is flashing.
- ↓ ↑ Set the T2 time value (duration of the measurement). The bottom secondary display (item 11 par. 4.2) will show the value you are setting. The shortest time that can be set is 15" (seconds).
- SeT** The V1 parameter indicator is flashing.

↓ ↑ Set the V1 voltage value you want (testing start voltage). The top secondary display (item 10 par. 4.2) will show the value you are setting.

NOTE: The value of V1 CANNOT be greater than that of V2.

SeT The T1 parameter indicator is flashing.

↓ ↑ Set the T1 time value (duration of the rising voltage ramp from value V1 to value V2). The bottom secondary display (item 11 par. 4.2) will show the value you are setting. The shortest time that can be set is 15" (seconds).

SeT Exit the programming phase. The flashing measuring mode advises you that you can save the settings.

SavE Saving the parameters in the location first selected (if requested).

StarT "Go ?" prompt displayed, **PRESS START** again to start measuring.

4.5.6 Measurement of polarization index

PI

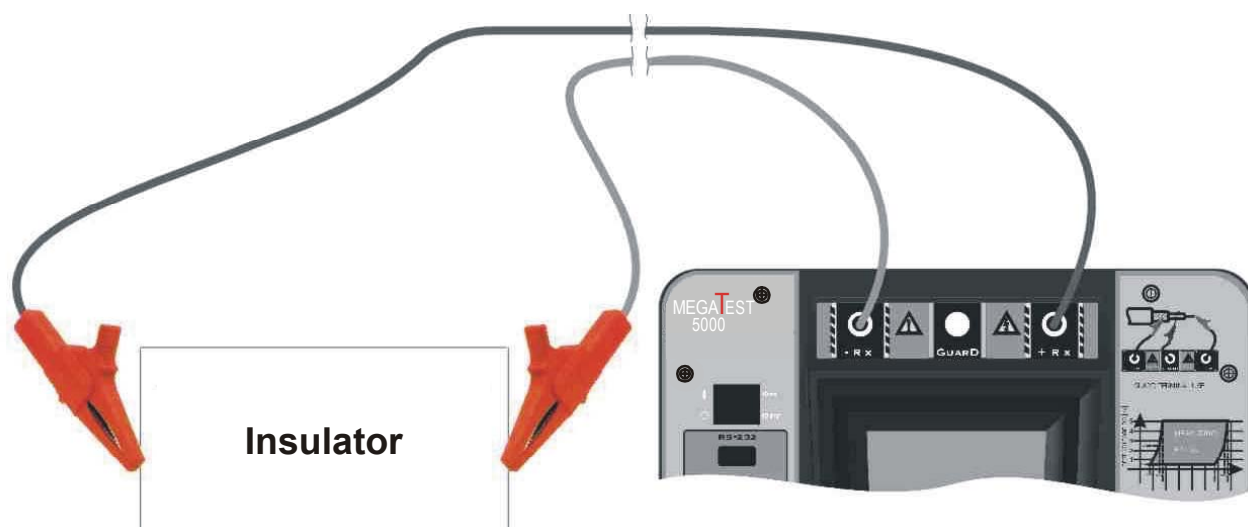

It's common knowledge that a good insulator, if subject to voltage, shows a gradual resistance increase over a period of time. Vice versa, a resistance decrease indicates bad quality of the insulator (or presence of dirt affecting the measurement).

The polarization index is defined as the ratio between the resistance value measured after 10 minutes and the resistance value measured after 1 minute from application of the test voltage. Therefore it's an important indicator of the insulator quality. Indicative information about the insulator features, but not so accurate as the polarization index, are provided by the ratio between the resistance value measured after 60 seconds and the resistance value measured after 30 seconds. Already after one minute it's possible to verify if the resistance value has considerably increased (as hoped) or, on the contrary, it's unchanged or, still worse, it has decreased.

This measuring method, based on resistance ratios, gives a dimensionless result, independent on a series of factors such as equipment size, temperature or environmental conditions.

Insulator status	60/30 sec ratio	Polarization index 10/1 min ratio
dangerous	—	less than 1
questionable	1.0 ÷ 1.25	1.0 ÷ 2
good	1.4 ÷ 1.6	2 ÷ 4
excellent	more than 1.6	more than 4

Tab. 1: Insulator status as revealed by the polarization index.

The measurement of the polarization index of a dielectric can be taken by manufacturers of electrical equipment to test, for example, materials to be used for the production of supports for conductors, components and devices, insulation of motor coils.

KEY OPERATION

↓ ↑

Reach the memory cell P20. PI is displayed.

SeT The V2 parameter indicator is flashing.

↓ ↑

Set the desired V2 voltage value (test voltage) between 100 and 5000V. The top secondary display will show the value you are setting.

SeT The T2 parameter indicator is flashing.

SeT Leave the programming phase. The flashing measuring mode **TIMER** advises that you can save the settings.

SaveE Save the parameters in the location previously selected (if requested).

StarT The message “go?” is displayed.

StarT The measurement is started.

- The test can be interrupted at any time (provided that at least 75 seconds have passed from starting).
- At the end of the measurement the PI value is displayed. Press MODE to display the last resistance value measured.
- Press SAVE to store the measured values.
- It's possible to recall the measured values. Press SET/EXIT to run over the PI values, the resistance values and the measuring parameters.

4.6 Examples of insulation measurement

Connect the terminals of the insulation you want to measure to the high voltage jacks. Connect the Guard to a suitable point near the negative terminal (ref. "Use of the GUARD" – heading 2.5).

WARNING



Comply with the instructions in the manual, especially refer to chapter 1. "Accident prevention and safety measures". Improper use could lead to damage to the instrument or to the equipment being tested.



WHILE MEASURING DO NOT TOUCH THE CONNECTIONS OF THE TEST LEADS.

The instrument is equipped with a discharge circuit for the capacities connected to the measuring terminals. When measuring has been completed, therefore, **DO NOT DISCONNECT THE TEST LEADS UNTIL THE "MEASUREMENT UNDERWAY" SYMBOLS HAVE DISAPPEARED**.

4.6.1 Measuring the insulation of the windings of an electrical machine

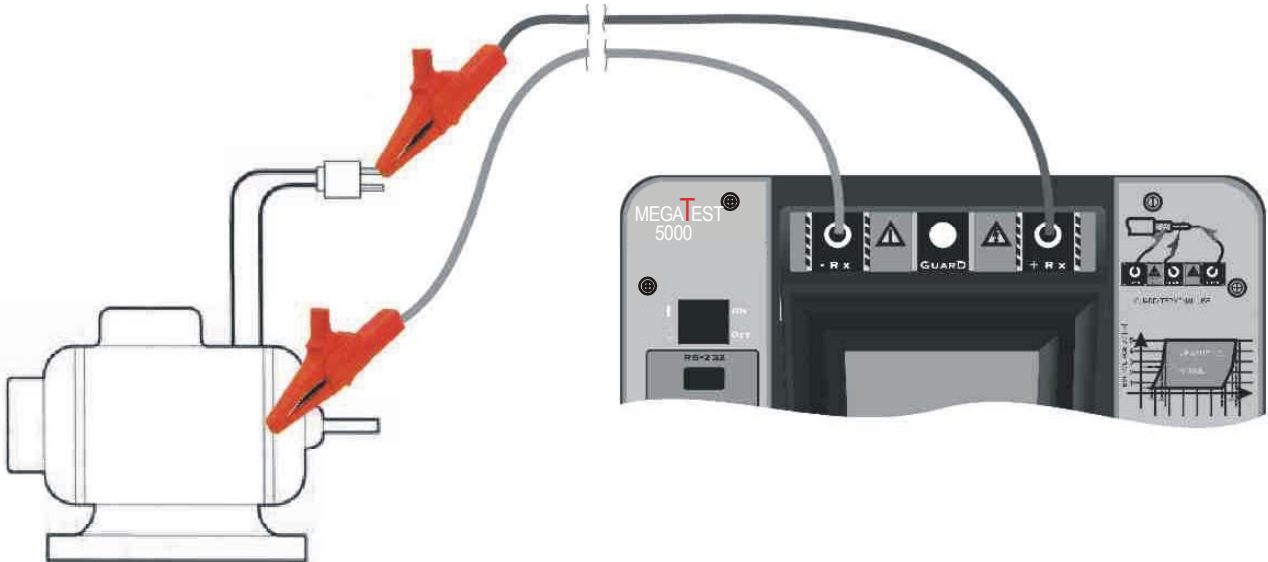

This measurement can be employed by manufacturers and repair engineers of electric motors or transformers in order to check out the efficiency of the product and its compliance with specific regulations.

- Connect the instrument between the frame (on a paint-free part) and the windings (connect these to each other if they are separated) of the motor.
- Pre-set configurations can be used, for example choosing P25 with the up or down arrows, one can set a measurement at 500 V for 1' (minute).
- Should you intend to perform tests using other parameters, choose the appropriate settings (ref. Section 4.5)

- Press START, wait until the measuring is over and make sure the value measured is consistent with what you requested.
- If necessary, save the measurement you performed by pressing the SAVE key (ref. chapter 4.7).

4.6.2 Measuring on a power plant

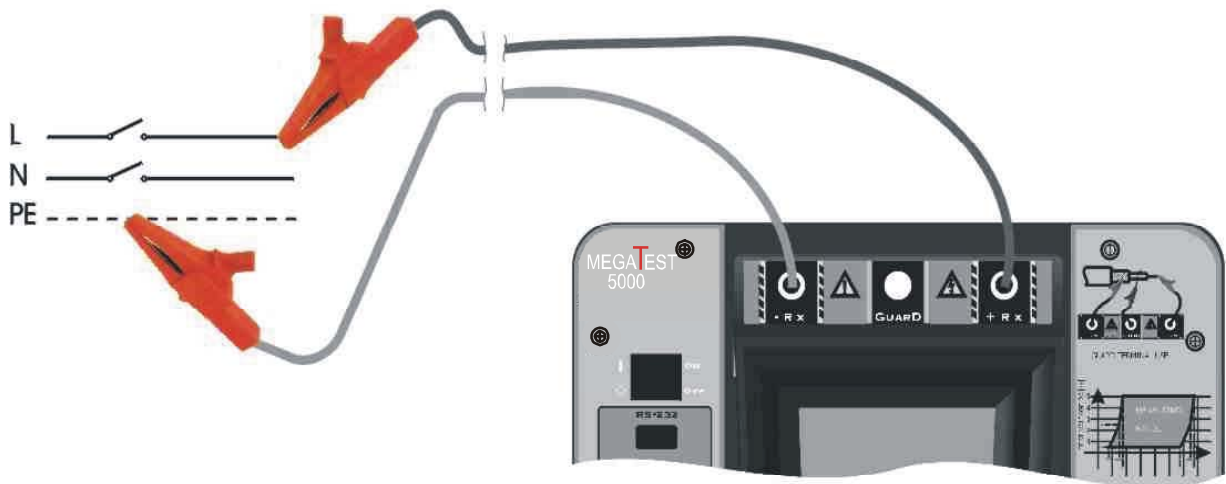

Technicians and repair engineers may use this instrument in order to check out the efficiency of the system and its compliance with specific regulations.

- Connect the instrument between each cable to be tested and the ground.
- Pre-set configurations can be used. For example, use the up or down arrow keys to select P25: this will set a measurement of 500 V for 1' (minute).
- Should you intend to perform tests using other parameters, choose the appropriate settings (ref. chapter 4.5).
- Press START, wait until the measuring is over and make sure the value measured is consistent with what you requested.
- If necessary, save the measurement you performed by pressing the SAVE key (ref. chapter 4.7).

4.6.3 Checking the efficiency of an insulator



This measurement can be employed by manufacturers of electrical equipment to check materials, such as supports for conductors, components and equipment.

- Connect the test leads to the material being tested, placing them at the distance to be verified and making sure there is proper contact.
- Pre-set configurations can be used. For example, use the up or down arrow keys to select P20: this will set a measurement of 2500 V for 10'.
- Should you intend to perform tests using other parameters, choose the appropriate settings (ref. chapter 4.5).
- Press START, wait until the measuring is over and make sure the value measured is consistent with what you requested.
- If necessary, save the measurement you performed by pressing the SAVE key (ref. chapter 4.7).

4.6.4 Estimating the insulating strength



This measurement can be employed by manufacturers of electrical equipment to check materials for example for making supports for conductors, components and equipment.

- Connect the test leads to the material being tested, placing them at the distance to be verified and making sure there is proper contact.
- Pre-set configurations can be used. For example, use the up or down arrow keys to select P21: this will set a measurement of 5000 V for 2' (minutes) with a ramp increase.
- Should you intend to perform tests using other parameters, choose the appropriate settings (ref. chapter 4.5).
- Press START and observe the value of the resistance during the test.
- Stop the test manually (STOP key) as soon as the resistance starts to diminish or as soon as there is a discharge. The voltage reached before stopping the test is the maximum applicable voltage, and a reasonable safety margin should be kept compared to it.
- If necessary, save the measurement you performed by pressing the SAVE key (ref. chapter 4.7).
- If you want, you can proceed to test the efficiency of the insulator.

4.7 Saving the measurements which were performed

Once measurement has been finished, you can press the SAVE key to save the performed measurement with all the parameters employed during testing.

The top secondary display (item 10 par. 4.2) shows for three seconds the number of the memory location where the measurement was memorised. Up to 200 measurements can be memorised.

4.8 Recalling memorised measurements

KEY	OPERATION
-----	-----------

Recall	With the instrument in waiting condition (i.e. when there are no current operations), press Recall to read all stored measurements. The last one to be performed will be the first to be displayed. The number of the measurement is shown on the top secondary display (item 10 par. 4.2).
---------------	---

↓ ↑	These allow you to run through all the measurements stored in memory (with an overall total of 200 measurements).
-----	---

SeT	This displays all the parameters the measurement was performed with on the relevant displays.
------------	---

Recall	This shuts down the memory recall mode and goes back to the waiting condition.
---------------	--

4.9 PRINTING OUT MEMORISED MEASUREMENTS

Note: Connect the instrument to your PC using the RS 232 serial cable provided. (see Section 4.13)

KEY	OPERATION
-----	-----------

Recall	With the instrument in waiting condition (i.e. when there are no current operations), press Recall to enter the measurement display mode.
---------------	---

↓ ↑	Reach the memorised measurement you want to start printing from. The number of the measurement is shown on the top secondary display (item 10 par. 4.2).
-----	--

PrinT	Start printing out the measurements, from the displayed one to the last one. To interrupt printing, keep SET/EXIT <u>pressed</u> until printing stops.
--------------	--

Recall	This shuts down the memory recall mode and goes back to the waiting condition.
---------------	--

4.10 Deleting memorised memories

KEY OPERATION

Recall With the instrument in waiting condition (i.e. when there are no current operations), press Recall to enter the measurement display mode.

↓ ↑ This reaches the memory location you want to start deleting with. The number of the measurement is shown on the top secondary display (item 10 par. 4.2).

CleaR The initials "clr" are displayed on the bottom secondary display (item 11 par. 4.2). To cancel deletion press SET/EXIT.

CleaR Confirm deletion command: every location is deleted **from the one displayed to very last one**. Once the operation is over, the location previous to the one where deletion was started will be displayed. If deletion starts from location No. 001, the instrument will go automatically back to its waiting condition.

Recall Exit from the memory mode if you did not exit it already during deletion (see previous item).

4.11 Restoring the initial configuration

To clear the memory of the instrument completely, proceed as follows:

- Turn the instrument off.
- Keep the MODE/CLR key pressed while turning the instrument back on.
- After a few seconds, the message "rES" will appear on the main display confirming that resetting has taken place.
- Let the MODE/CLR key go.

This operation clears the entire memory of measurements and restores the initial condition of the measuring configuration (ref. chapter 4.4.1).

4.12 Error code description

Should there be an error, one of the following messages will appear on the display:

Er0: the memory of performed measurements is full.

Er1: the circuit being measured was not discharged correctly within the maximum time.



CAUTION

When the message Er1 is present, discharge the system manually, **WITHOUT TOUCHING ANY LIVE PART**. Then check for any break in the connections.

4.13 Use of the serial port

Connect the instrument to the serial port of your PC using the 9 pin RS 232 serial cable provided.

In case your PC has a 25-pin connector simply use a standard 9 pin to 25 pin adapter (not provided)

4.13.1 Reading and downloading the results of the measurements on a computer

If the "SUPERLINK" software has previously been installed, simply turn the instrument on and start up the "SUPERLINK" Program on the computer.

To install the "SUPERLINK" software refer to the instructions on the floppy disk or CD.

Refer to the "Help" menu on the "SUPERLINK" for information on software use.

5 Maintenance

5.1 Replacing the batteries



CAUTION

- Before opening the lid of the battery compartment, disconnect the test leads from the instrument.
- Always make sure the system has finished discharging before disconnecting the test leads or opening the battery compartment.

When the "low battery" indicator (chap. 4.2, symbol 4) appears on the instrument, replace the batteries.

Measurements can still be performed with the "low battery" indicator lit, but on very low resistance, the rated voltage might not be achieved; in this case, the results would no longer be valid.

- Finish any measurement you may be performing.
- Wait for the output voltage to finish discharging.
- Turn the instrument off.
- Disconnect the test leads.
- Use a screwdriver or coin to remove the 4 screws on the battery compartment door, located on the bottom of the instrument.
- Use 4 each, 1.5-volt, "D" size alkaline batteries.
- Always use fresh batteries to replace the used ones, and replace all the batteries at the same time (no partial replacement).

5.2 Cleaning the instrument

Clean the instrument regularly in order to remove any dust or other residue, which could conduct current or falsify the results of the measurements.

To clean the instrument, use a soft and dry cloth, which can be lightly dipped in alcohol.

Never use damp cloths, solvents, water, etc.

6 Technical specifications

6.1 Technical features

Accuracy is shown in terms of [% of the reading + number of digits]. It refers to the following ambient conditions: temperature 73°F +/- 2° (23 °C +/- 1°) with relative humidity < 75%.

6.1.1 Measuring the insulation.

Range	Accuracy			
	100 .. <500 V	500 .. <1000 V	1000 .. 2500 V	2500 .. 5000 V
100 K - 500 K	±(20% + 10dgt)	±(20% + 10dgt)	±(20% + 10dgt)	±(20% + 10dgt)
500 K - 50 G	±(5% + 1dgt)	±(5% + 1dgt)	±(5% + 1dgt)	±(5% + 1dgt)
50 G - 100 G	±(20% + 10dgt)	±(5% + 1dgt)	±(5% + 1dgt)	±(5% + 1dgt)
100 G - 250 G	- - -	±(20% + 10dgt)	±(5% + 1dgt)	±(5% + 1dgt)
250 G - 500 G	- - -	- - -	±(20% + 10dgt)	±(5% + 1dgt)

Minimum resistance resolution: 1%
 Voltage indication resolution: 1.22 V

6.1.2 Current which can be delivered

Voltage setting	Max current
100 - 500 V	3.00 mA
1000 - 5000 V	1.40 mA

The output current is automatically limited.

6.1.3 Voltage measurement

Voltage range	Resolution	Accuracy
0 - 500 V	1,22V	±(10%+10 dgt)
500 - 5000 V	1,22V	±(10%+ 5 dgt)

The limits shown here are valid both for DC of any polarity and for AC.

Discharge time at 5000V: <1.5s x μF.

6.1.4 Safety

Instrument according to standard: EN 61010-1
 Insulation: Class 2, Double insulation
 Pollution level: 2
 Indoors use; max altitude: 6,562 feet (2000 m)
 Over-voltage category: CAT III 600V
 Serial port insulation: 25 mm. (max. 5000 V)

6.2 General features

6.2.1 Electric features

Measuring method:	voltamperometric system
Parameter memory:	20 different parameters
Stored measurements:	200 measurements with their parameters and results
RS232:	DIN 9 pin

6.2.2 Safety

The measurement is stopped when there is voltage at the test leads that could damage the instrument.

Discharge of the remaining voltage at the end of the measurement or when the instrument has been turned off.

6.2.3 Mechanical features

Size:	290(L) x 340(W) x 145(H) mm 11.5(L) x 13(W) x 5.75(H) inches
-------	---

Weight	8.8 Lbs. (4 Kg)
--------	-----------------

6.2.4 Power supply

Battery Type:	4 each, 1.5 volt, "D" size alkaline
"Low Battery" indication:	"Battery" symbol appears on the display
Endurance:	250 meas. V = 5000 V Rx = 5 M Ω t = 1 min 450 meas. V = 500 V Rx = 500k Ω t = 1 min
Automatic Turn Off	Turns off after 10 minutes without use.

6.2.5 Display

Features:	LCD 1 unit 3 dgt., 2 units 4 dgt., bargraph 32 segments + other symbols.
Updating speed:	max. 2 sec. depends on the value of the resistance being measured and on the stray capacitance present in parallel. During the first 15 sec. the resistance value is shown as "--").

6.3 Ambient conditions

6.3.1 Ambient conditions of use

Temperature of reference:	73° F +/- 1° (23°C +/- 1°)
Operating Temperature:	41 - 104° F (5 - 40°C)
Permitted relative humidity:	< 80%
Storage temperature:	14 -140° F (-10 - 60 °C)
Storage humidity	< 70%
Noise level:	< 40 dB

6.3.2 EMC

This instrument has been designed to comply with current EMC standards and electromagnetic compatibility has been tested under:

EN 50081-1, EN 50082-1

This instrument complies with the requirements of the European Directive on low voltage 72/23/EEC and with the EMC 89/336/EEC directive, modified under 93/68/EEC.

6.4 Standard equipment

The package contains:

- The instrument received
- Three test leads provided with a safety boot and an alligator clip
- Instruction manual
- Serial cable for computer connection
- CD-ROM with "SUPERLINK" software for downloading/reading measurements

6.5 Replacement parts

<u>Part Description</u>	<u>Part #</u>
Carrying Case	MT5-CC
Download Cable	GP-RS232
Test Leads Set (complete set of 3)	MT5-LEADS

7 Warranty conditions

Congratulations! You are now the owner of an AMPROBE Instrument. It has been quality crafted according to quality standards and contains quality components and workmanship. This instrument has been inspected for proper operation of all of its functions. It has been tested by qualified factory technicians according to the long -established standards of AMPROBE INSTRUMENT.

Your AMPROBE instrument has a limited warranty against defective materials and/or workmanship for one year from the date of purchase provided that, in the opinion of the factory, the instrument has not been tampered with or taken apart.

Should your instrument fail due to defective materials, and/or workmanship during this one-year period, please have your dated bill of sale which must identify the instrument model number and serial number and call the number listed below:

Service Division
AMPROBE INSTRUMENT
Miami, Florida 33150
Tel: 800-327-5060

Outside the U.S.A. the local Amprobe representative will assist you. Above limited warranty covers repair and replacement of instrument only and no other obligation is stated or implied.

7.1 After-sales service

If the instrument fails to operate, check battery, test leads, etc and replace as necessary. If the instrument still malfunctions, please call the phone number listed below:

Service Division
AMPROBE INSTRUMENT
Miami, Florida 33150
Tel: 800-327-5060

Outside the U.S.A. the local Amprobe representative will assist you.



Miami, FL 33150
(305) 423-7500
(800) 327-5060

Mouser Electronics

Authorized Distributor

Click to View Pricing, Inventory, Delivery & Lifecycle Information:

[AMPROBE:](#)

[AMB-5KV-D](#)