

**FEATURES**
**Radio frequency (RF) ranges**

- 169.4 MHz to 169.6 MHz
- 426 MHz to 470 MHz
- 863 MHz to 960 MHz

**Data rates**

- 2FSK/2GFSK: 0.1 kbps to 300 kbps
- 4FSK/4GFSK: 1 kbps to 360 kbps (transmit only)

**Dual power amplifiers (PAs)**
**Programmable receiver channel bandwidth (BW) from**

- 2.6 kHz to 738 kHz

**Receiver (Rx) performance**

- Up to 102 dB blocking at  $\pm 20$  MHz offset
- Up to 66 dB adjacent channel rejection
- 134.3 dBm sensitivity at 0.1 kbps
- 121.2 dBm sensitivity at 2.4 kbps

**Transmitter (Tx) performance**

- 20 dBm to +17 dBm range with 0.1 dB step resolution
- Very low output power variation vs. temperature and supply

**Low active current**

- 50 mA Tx current at 17 dBm
- 21.2 mA Rx current at 12.5 kbps

**Ultralow sleep current**

- 10 nA with memory retained
- Autonomous smart wake modes

**Host microprocessor interface**

- Easy to use programming serial peripheral interface (SPI)
- Configurable 8-bit general-purpose input/output (GPIO) bus

**On-chip ARM Cortex-M0 processor for**

- Radio control and calibration
- Packet management
- Clear channel assessment (CCA)

**IEEE802.15.4g support**

- Frame format
- Data whitening
- Dual-sync word detection
- Forward error correction (FEC) and interleaving

**Suitable for systems targeting compliance with**

- ETSI EN 300 220-1
- EN 54-25, EN 13757-4
- FCC Part 15, Part 22, Part 24, Part 90, and Part 101
- ARIB STD-T30, STD-T67, STD-T108, STD-T96

**Packages**

- 6 mm  $\times$  6 mm, 40-lead LFCSP
- 7 mm  $\times$  7 mm, 48-lead LQFP

**APPLICATIONS**

- IEEE 802.15.4g (MR-FSK PHY)
- Wireless M-Bus (EN 13757-4)
- Smart metering
- Security and building automation
- Active tag asset tracking
- Industrial control
- Wireless sensor networks (WSNs)

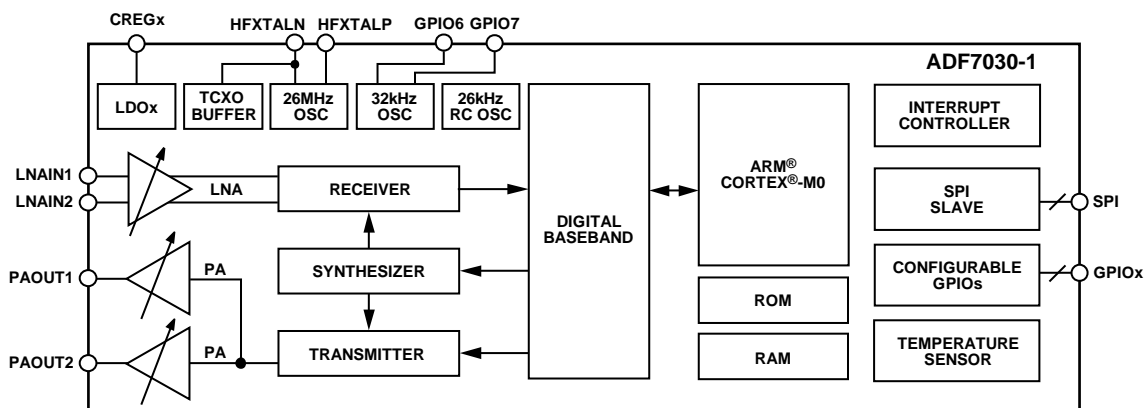
**FUNCTIONAL BLOCK DIAGRAM**

NOTES  
1. CREGx, GPIOx, AND SPI CONTAIN MULTIPLE PINS.

Figure 1.

14372-001

Rev. 0

**Document Feedback**

Information furnished by Analog Devices is believed to be accurate and reliable. However, no responsibility is assumed by Analog Devices for its use, nor for any infringements of patents or other rights of third parties that may result from its use. Specifications subject to change without notice. No license is granted by implication or otherwise under any patent or patent rights of Analog Devices. Trademarks and registered trademarks are the property of their respective owners.

# ADF7030-1\* Product Page Quick Links

Last Content Update: 11/01/2016

---

## [Comparable Parts](#)

View a parametric search of comparable parts

## [Evaluation Kits](#)

- [ADF7030-1 Evaluation and Development Kit](#)

## [Documentation](#)

### **Data Sheet**

- [ADF7030-1: High Performance, Sub GHz Radio Transceiver IC Data Sheet](#)

### **User Guides**

- [UG-1002: ADF7030-1 Software Reference Manual](#)
- [UG-1006: ADF7030-1 EZ-KIT User Guide](#)
- [UG-957: ADF7030-1 Hardware Reference Manual](#)

## [Reference Materials](#)

### **Press**

- [Transceiver Provides Reliable Radio Connections and Extended Battery Life for IoT and Other Wireless Applications](#)

## [Design Resources](#)

- [ADF7030-1 Material Declaration](#)
- [PCN-PDN Information](#)
- [Quality And Reliability](#)
- [Symbols and Footprints](#)

## [Discussions](#)

View all ADF7030-1 EngineerZone Discussions

## [Sample and Buy](#)

Visit the product page to see pricing options

## [Technical Support](#)

Submit a technical question or find your regional support number

**TABLE OF CONTENTS**

Features .....	1	460 MHz—Transmit .....	34
Applications .....	1	868 MHz—Receive .....	36
Functional Block Diagram .....	1	868 MHz—Transmit .....	38
Revision History .....	2	915 MHz—Receive .....	40
General Description .....	3	915 MHz—Transmit .....	42
Specifications .....	4	Theory of Operation .....	44
Temperature and Voltage .....	4	State Machine .....	44
General RF .....	4	Radio Timing .....	45
Receive .....	5	Host Interface .....	46
Transmit .....	6	Receiver .....	46
Current Consumption .....	8	Transmitter .....	48
Band Specific Receive and Transmit .....	9	Calibration .....	49
External 26 MHz Oscillator .....	19	Packet Handling .....	50
Low Frequency Oscillator .....	19	Applications Information .....	51
Temperature Sensor .....	19	Typical Application Circuit .....	51
Digital Input/Output .....	20	Silicon Anomaly .....	52
Digital Timing .....	20	ADF7030-1 Functionality Issues .....	52
Absolute Maximum Ratings .....	22	Functionality Issues .....	52
ESD Caution .....	22	Development Support .....	53
Pin Configurations and Function Descriptions .....	23	Design Package .....	53
Typical Performance Characteristics .....	27	Reference Manuals .....	53
169 MHz—Receive .....	27	Evaluation Kits .....	53
169 MHz—Transmit .....	28	Evaluation Software .....	53
433 MHz—Receive .....	30	Outline Dimensions .....	54
433 MHz—Transmit .....	31	Ordering Guide .....	55
460 MHz—Receive .....	33		

**REVISION HISTORY**

6/2016—Revision 0: Initial Version

## GENERAL DESCRIPTION

The [ADF7030-1](#) is a fully integrated, radio transceiver achieving high performance at very low power. The [ADF7030-1](#) is ideally suited for applications that require long range, network robustness, and long battery life. It is suitable for applications that operate in the ISM, SRD, and licensed frequency bands at 169.4 MHz to 169.6 MHz, 426 MHz to 470 MHz, and 863 MHz to 960 MHz. It provides extensive support for standards-based protocols like IEEE802.15.4g while also providing flexibility to support a wide range of proprietary protocols.

The highly configurable low intermediate frequency (IF) receiver supports a large range of receiver channel bandwidths from 2.6 kHz to 738 kHz. This range of receiver channel bandwidths allows the [ADF7030-1](#) to support ultranarrow-band, narrow-band, and wideband channel spacing.

The [ADF7030-1](#) features two independent PAs supporting output power ranges of -20 dBm to +13 dBm and -20 dBm to +17 dBm. The PAs support ultrafine adjustment of the power with a step resolution of 0.1 dB. The PA output power is exceptionally robust over temperature and voltage. The PAs have an automatic power ramp control to limit spectral splatter to meet regulatory standards.

The [ADF7030-1](#) features an on-chip ARM® Cortex®-M0 processor that performs radio control, radio calibration, and packet management. Cortex-M0 eases the processing burden of the host processor because the [ADF7030-1](#) integrates the lower layers of a typical communication protocol stack. This internal processor also permits the download and execution of Analog Devices, Inc., provided firmware modules that can extend the functionality of the [ADF7030-1](#).

The [ADF7030-1](#) has two packet modes: generic packet mode and IEEE802.15.4g mode. In generic packet mode, the packet format is highly flexible and fully programmable, thereby ensuring its compatibility with proprietary packet formats. In IEEE802.15.4g packet mode, the packet format conforms to the IEEE802.15.4g standard. FEC, as per the IEEE802.15.4g standard, is also supported.

The [ADF7030-1](#) operates with a power supply range of 2.2 V to 3.6 V and has very low power consumption in both Tx and Rx modes, enabling long lifetimes in battery-operated systems. An

ultralow power deep sleep mode achieves a typical current of 10 nA with the configuration memory retained.

The [ADF7030-1](#) supports smart wake mode (SWM) where the [ADF7030-1](#) can wake up autonomously from sleep using an internal real-time clock (RTC) without intervention from the host processor. After wake-up, the [ADF7030-1](#) operates autonomously. This functionality allows carrier sense, packet sniffing, and packet reception while the host processor is in sleep mode, thereby reducing overall system current consumption. The [ADF7030-1](#) autonomous operation can also be triggered by the host processor using the interrupt input of the [ADF7030-1](#).

A complete wireless solution can be built using a small number of external discrete components and a host processor (typically a microcontroller). The host processor can configure the [ADF7030-1](#) using a simple command-based protocol over a standard 4-wire SPI interface. A single-byte command transitions the radio between states or performs a radio function.

The [ADF7030-1](#) is available in two package types: a 6 mm × 6 mm, 40-lead LFCSP and a 7 mm × 7 mm, 48-lead LQFP. Both package types use NiPdAu plating to mitigate against silver migration in high humidity applications. The [ADF7030-1](#) operating temperature range is -40°C to +85°C.

For Figure 13 to Figure 19, Figure 30, Figure 42, Figure 60, Figure 61, and Figure 77 in the Typical Performance Characteristics section, PA\_COARSE is a programmable value that provides a coarse adjustment of the PA output power. This value can be programmed in the range of 1 to 6 for PA1, and from 1 to 10 for PA2. PA\_FINE is a programmable value that provides a fine adjustment of the PA output power. This value can be programmed in the range of 3 to 127 for both PA1 and PA2. PA\_MICRO is a programmable value that provides a microadjustment (typically <0.1 dB) of the PA output power. This value can be programmed in the range of 1 to 31 for both PA1 and PA2. PAOLD0\_VOUT\_CON is a programmable value that configures the internal LDO voltage that provides bias for the PA. For additional information on these bit settings, see the [ADF7030-1 Software Reference Manual](#), which is the detailed programming guide for the device.

## SPECIFICATIONS

$V_{DD} = V_{BAT1} = V_{BAT2} = V_{BAT3} = V_{BAT4} = V_{BAT5} = V_{BAT6} = 2.2 \text{ V to } 3.6 \text{ V}$ , exposed pad (EPAD) = 0 V (ground),  $T_A = T_{MIN}$  to  $T_{MAX}$ , unless otherwise noted. Typical specifications are at  $V_{DD} = 3 \text{ V}$ ,  $T_A = 25^\circ\text{C}$ , unless otherwise noted. All VBATx pins must be tied together. A one-time radio calibration is required, unless otherwise noted.

### TEMPERATURE AND VOLTAGE

Table 1.

Parameter	Min	Typ	Max	Unit	Test Conditions/Comments
TEMPERATURE RANGE, $T_A$	-40		+85	$^\circ\text{C}$	
VOLTAGE SUPPLY					
VBATx Pin Voltage	2.2		3.6	V	Transmit power $\leq 13 \text{ dBm}$
	2.85		3.6	V	Transmit power $\geq 17 \text{ dBm}$ , PA LDO voltage = 2.65 V
	PA LDO voltage + 0.2 V		3.6	V	Transmit power $>13 \text{ dBm}$ and $< 17 \text{ dBm}$ ; the PA LDO voltage is configurable

### GENERAL RF

Table 2.

Parameter	Min	Typ	Max	Unit	Test Conditions/Comments
RF FREQUENCY					
Frequency Range		169.4	169.6	MHz	
		426	470	MHz	
		863	960	MHz	
Channel Frequency Resolution		1.5		Hz	
DATA RATE					
IEEE802.15.4g Packet Mode				kbps	
2FSK, 2GFSK Modulation		2.4	150	kbps	
Generic Packet Mode				kbps	
2FSK, 2GFSK Modulation		0.1	300	kbps	
4FSK, 4GFSK Modulation		1	360	kbps	Tx only, generic packet mode only
On/Off Keying (OOK) Modulation		16.384		kbps	Tx only, Manchester encoded, generic packet mode only
Resolution		1		bps	
FREQUENCY DEVIATION					
Range					
2FSK, 2GFSK Modulation		1	250	kHz	
4FSK, 4GFSK Modulation		1	250	kHz	Tx only, generic packet mode only
Resolution		100		Hz	
GAUSSIAN FILTER BANDWIDTH TIME (BT) PRODUCT		0.3, 0.35, 0.4, 0.5			Programmable

## RECEIVE

Table 3.

Parameter	Min	Typ	Max	Unit	Test Conditions/Comments
MAXIMUM DATA RATE ERROR TOLERANCE		±0.1		%	
RECEIVER CHANNEL FILTER BANDWIDTH					Programmable; see Table 27 and Table 28 for a list of all supported values
Narrow-Band Mode					
Maximum		20.0		kHz	
Minimum		2.6		kHz	
Wideband Mode					
Maximum		738		kHz	
Minimum		77		kHz	
MAXIMUM RF INPUT LEVEL		10		dBm	
RECEIVER LINEARITY					Measured at maximum receiver gain
Input Third-Order Intercept (IIP3)		-8.5		dBm	Receiver channel frequency = 169.43125 MHz, f <sub>SOURCE1</sub> = 171.35 MHz, f <sub>SOURCE2</sub> = 173.26875 MHz
Input Second-Order Intercept (IIP2)		53		dBm	Receiver channel frequency = 169.53125 MHz, f <sub>SOURCE1</sub> = 171.55 MHz, f <sub>SOURCE2</sub> = 171.63125 MHz
1 dB Compression (P1dB)		-18.7		dBm	Receiver channel frequency = 169.43125 MHz, f <sub>SOURCE1</sub> = 171.43125 MHz
RECEIVED SIGNAL STRENGTH INDICATOR (RSSI)					Refer to the Typical Performance Characteristics section for further detail; sensitivity defined as bit error rate (BER) = 0.1%
Resolution		0.25		dB	
Calibrated Absolute Accuracy		±2		dB	-40 dBm to sensitivity + 6 dB; one-point offset calibration
DIFFERENTIAL LOW NOISE AMPLIFIER (LNA) INPUT IMPEDANCE, 40-LEAD LFCSP PACKAGE					
LNA in Rx Mode					
f = 169 MHz		78 - j20		Ω	
f = 433 MHz		69 - j25		Ω	
f = 460 MHz		68 - j25		Ω	
f = 868 MHz		56 - j29		Ω	
f = 915 MHz		55 - j30		Ω	
LNA in Tx Mode					Combined match enabled
f = 169 MHz		7 + j2		Ω	
f = 433 MHz		7 + j4		Ω	
f = 460 MHz		7 + j4		Ω	
f = 868 MHz		8 + j8		Ω	
f = 915 MHz		8 + j8		Ω	
DIFFERENTIAL LNA INPUT IMPEDANCE, 48-LEAD LQFP PACKAGE					
LNA in Rx Mode					
f = 169 MHz		78 - j16		Ω	
f = 433 MHz		71 - j18		Ω	
f = 460 MHz		73 - j22		Ω	
f = 868 MHz		58 - j20		Ω	
f = 915 MHz		57 - j20		Ω	
LNA in Tx Mode					Combined match enabled
f = 169 MHz		7 + j3		Ω	
f = 433 MHz		8 + j9		Ω	
f = 460 MHz		8 + j9		Ω	
f = 868 MHz		9 + j18		Ω	
f = 915 MHz		9 + j19		Ω	

## TRANSMIT

Table 4.

Parameter	Min	Typ	Max	Unit	Test Conditions/Comments	
<b>POWER AMPLIFIER (PA)</b>						
Power Amplifier 1 (PA1)						
Transmit Power Maximum		13		dBm	From $-40^{\circ}\text{C}$ to $+85^{\circ}\text{C}$ , transmit power = 13 dBm, RF frequency = 169 MHz From $V_{\text{DD}} = 2.2\text{ V}$ to $V_{\text{DD}} = 3.6\text{ V}$ , transmit power = 13 dBm, RF frequency = 169 MHz transmit power = 13 dBm, RF frequency = 169 MHz	
Transmit Power Minimum		-20		dBm		
Transmit Power Step Resolution		0.1		dB		
Transmit Power Variation vs. Temperature		$\pm 0.15$				
Transmit Power Variation vs. $V_{\text{DD}}$		$\pm 0.1$				
Transmit Power Accuracy		$\pm 0.3$				
Power Amplifier 2 (PA2)						
Transmit Power Maximum		17		dBm		
Transmit Power Minimum		13		dBm		
Transmit Power Step Resolution		-20		dBm		
Transmit Power Step Resolution		0.1		dB		
Transmit Power Variation vs. Temperature		$\pm 0.1$		dB		
Transmit Power Variation vs. $V_{\text{DD}}$		$\pm 0.1$		dB		
Transmit Power Accuracy		$\pm 0.25$		dB		
<b>PA IMPEDANCE, 40-LEAD LFCSP PACKAGE</b>						
Optimum PA Load While in Transmit						
PA1						
f = 169 MHz		50 + j0		$\Omega$	For guidance on impedance matching, refer to the <a href="#">ADF7030-1 Hardware Reference Manual</a>	
f = 433 MHz, f = 460 MHz		45 + j30		$\Omega$		
f = 868 MHz, f = 915 MHz		50 + j20		$\Omega$		
PA2						
f = 169 MHz		38 + j0		$\Omega$		
f = 433 MHz, f = 460 MHz		38 + j25		$\Omega$		
f = 868 MHz, f = 915 MHz		38 + j18.5		$\Omega$		
PA Input Impedance While in Rx						
PA1						
f = 169 MHz		7 - j232		$\Omega$		
f = 433 MHz		5 - j102		$\Omega$		
f = 460 MHz		5 - j96		$\Omega$		
f = 868 MHz		4 - j49		$\Omega$		
f = 915 MHz		4 - j46		$\Omega$		
PA2						
f = 169 MHz		5 - j177		$\Omega$		
f = 433 MHz		3 - j69		$\Omega$		
f = 460 MHz		3 - j65		$\Omega$		
f = 868 MHz		3 - j33		$\Omega$		
f = 915 MHz		3 - j31		$\Omega$		

Parameter	Min	Typ	Max	Unit	Test Conditions/Comments
PA IMPEDANCE, 48-LEAD LQFP PACKAGE					For guidance on impedance matching, refer to the <a href="#">ADF7030-1 Hardware Reference Manual</a>
Optimum PA Load While in Transmit					
PA1					
f = 169 MHz		45 + j 8		$\Omega$	
f = 433 MHz, f = 460 MHz		40 + j20		$\Omega$	
f = 868 MHz		40 + j20		$\Omega$	
f = 915 MHz		40 + j20		$\Omega$	
PA2					
f = 169 MHz		37 + j 9		$\Omega$	
f = 433 MHz, f = 460 MHz		30 + j25		$\Omega$	
f = 868 MHz, f = 915 MHz		30 + j15		$\Omega$	
PA Input Impedance While in Rx					
PA1					
f = 169 MHz		6 – j236		$\Omega$	
f = 433 MHz, f = 460 MHz		6 – j87		$\Omega$	
f = 868 MHz		5 – j37		$\Omega$	
f = 915 MHz		5 – j34		$\Omega$	
PA2					
f = 169 MHz		5 – j169		$\Omega$	
f = 433 MHz, f = 460 MHz		4 – j58		$\Omega$	
f = 868 MHz		3 – j22		$\Omega$	
f = 915 MHz		3 – j19		$\Omega$	



**CURRENT CONSUMPTION**

Table 5.

Parameter	Min	Typ	Max	Unit	Test Conditions/Comments
<b>TRANSMIT CURRENT CONSUMPTION</b>					
In the PHY_TX state transmitting a carrier					
f = 169.4 MHz					
Tx Power = 0 dBm, PA1		18		mA	
Tx Power = 10 dBm, PA1		31		mA	
Tx Power = 13 dBm, PA1		39		mA	
Tx Power = 17 dBm, PA2		65		mA	
f = 433 MHz					
Tx Power = 0 dBm, PA1		19		mA	
Tx Power = 10 dBm, PA1		31		mA	
Tx Power = 13 dBm, PA1		39		mA	
f = 460 MHz					
Tx Power = 17 dBm, PA2		50		mA	
f = 868 MHz, f = 915 MHz					
Tx Power = 0 dBm, PA1		20		mA	
Tx Power = 10 dBm, PA1		34		mA	
Tx Power = 13 dBm, PA1		43		mA	
Tx Power = 17 dBm, PA2		65		mA	
<b>RECEIVE CURRENT CONSUMPTION</b>					
In the PHY_RX state, waiting for preamble					
f = 169.4 MHz					
Data Rate = 4.8 kbps		24.8		mA	Narrow-band receive path
f = 433 MHz, f = 460 MHz					
Data Rate = 4.8 kbps		24.5		mA	Narrow-band receive path
Data Rate = 50 kbps		24		mA	Wideband receive path
f = 868 MHz, f = 915 MHz					
Data Rate = 5 kbps		23.2		mA	Narrow-band receive path
Data Rate = 12.5 kbps		21.2		mA	Wideband receive path
Data Rate = 50 kbps		21.4		mA	Wideband receive path
Data Rate = 100 kbps		23.7		mA	Wideband receive path
Data Rate = 150 kbps		24		mA	Wideband receive path
Data Rate = 300 kbps		25.4		mA	Wideband receive path
<b>RADIO STATE CURRENT CONSUMPTION</b>					
PHY_SLEEP State					
		2		nA	Memory not retained, no wakeup oscillator enabled, RTC disabled
		10		nA	Memory retained, no wakeup oscillator enabled, RTC disabled
		1		μA	Memory retained, internal 26 kHz RC oscillator enabled, RTC enabled
		1		μA	Memory retained, external 32 kHz oscillator enabled, RTC enabled
PHY_OFF State		1.9		mA	First entry to PHY_OFF after wake from PHY_SLEEP or after reset event
PHY_OFF State		3.7		mA	Second and subsequent entries to PHY_OFF after wake from PHY_SLEEP or after reset event
PHY_ON State		3.7		mA	

**BAND SPECIFIC RECEIVE AND TRANSMIT****169.4 MHz to 169.6 MHz**

Unless otherwise noted, the configurations detailed in Table 6 are used to specify the performance of the ADF7030-1 in Table 7. All measurements are performed on the EV-ADF70301-169BZ evaluation board, unless otherwise noted. The EV-ADF70301-169BZ uses a separate transmit/receive match design and a 26 MHz thermally compensated crystal oscillator (TCXO) reference. N/A means not applicable.

**Table 6. Configurations in the 169.4 MHz to 169.6 MHz Frequency Band**

Configuration Name	RF Frequency (MHz)	Data Rate (kbps)	Modulation	Frequency Deviation (kHz)	Channel Spacing (kHz)	IF Frequency (kHz)	Receiver BW (kHz)	Packet Setup for Packet-Based Testing
169.41875 MHz/ 0.1 kbps	169.41875	0.1	2GFSK	0.5	N/A	81.25	2.6	Preamble = 0xAAAA, sync word = 0xF672, payload length = 23 bytes, cyclic redundancy check (CRC) = 2 bytes
169.43125 MHz/ 2.4 kbps	169.43125	2.4	2GFSK	2.4	12.5	81.25	8.7	Preamble = 0x5555, sync word = 0xF672, payload length = 23 bytes, CRC = 2 bytes
169.41875 MHz/ 4.8 kbps	169.41875	4.8	2GFSK	2.4	12.5	81.25	10.6	Preamble = 0x5555, sync word = 0xF672, payload length = 23 bytes, CRC = 2 bytes
169.46875 MHz/ 6.4 kbps	169.46875	6.4	4GFSK	3.2 (outer deviation)	12.5	N/A (Tx only)	N/A (Tx only)	N/A

**Table 7. Specifications in the 169.4 MHz to 169.6 MHz Frequency Band**

Parameter	Min	Typ	Max	Unit	Test Conditions/Comments
SENSITIVITY, PACKET ERROR RATE (PER)					
Configuration 169.41875 MHz/0.1 kbps		-134.3		dBm	At PER = 5%, automatic frequency control (AFC) disabled
Configuration 169.43125 MHz/2.4 kbps		-121.2		dBm	At PER = 5%, AFC enabled, RF frequency error range = ±11.5 ppm
Configuration 169.41875 MHz/4.8 kbps		-119.4		dBm	At PER = 5%, AFC enabled, RF frequency error range = ±11.5 ppm
CHANNEL SELECTIVITY AND BLOCKING— BER-BASED TEST METHOD					Desired signal 3 dB above the input sensitivity level (BER = 0.1%), carrier wave (CW) interferer power level increased until BER = 0.1%; AFC disabled, image calibrated
Configuration 169.43125 MHz/2.4 kbps					
Adjacent Channel (±12.5 kHz)		66		dB	
Alternate Channel (±25 kHz)		66		dB	
±2 MHz		94		dB	
±10 MHz		92		dB	
±20 MHz		102		dB	
Configuration 169.41875 MHz/4.8 kbps					
Adjacent Channel (±12.5 kHz)		55		dB	
Alternate Channel (±25 kHz)		63		dB	
±2 MHz		92		dB	
±10 MHz		90		dB	
CHANNEL SELECTIVITY AND BLOCKING— PER-BASED TEST METHOD					Desired signal 3 dB above the input sensitivity level (PER = 5%), CW interferer power level increased until PER = 5%, AFC enabled, image calibrated
Configuration 169.43125 MHz/2.4 kbps					
Adjacent Channel (±12.5 kHz)		62		dB	
Alternate Channel (±25 kHz)		70		dB	
±2 MHz		94		dB	
±10 MHz		96		dB	
Configuration 169.41875 MHz/4.8 kbps					
Adjacent Channel (±12.5 kHz)		55		dB	

Parameter	Min	Typ	Max	Unit	Test Conditions/Comments
Alternate Channel ( $\pm 25$ kHz)		69		dB	
$\pm 2$ MHz		91		dB	
$\pm 10$ MHz		95		dB	
CHANNEL SELECTIVITY AND BLOCKING— ETSI EN 300 220-1 TEST METHOD Configuration 169.43125 MHz/2.4 kbps					Measured as per EN 300 220-1 V2.4.1, AFC disabled  Desired signal level = $-106.7$ dBm (3 dB above the reference sensitivity level)
$\pm 2$ MHz		-15		dBm	
$\pm 10$ MHz		-12		dBm	
Configuration 169.41875 MHz/4.8 kbps					Desired signal level = $-105.8$ dBm (3 dB above the reference sensitivity level)
$\pm 2$ MHz		-16		dBm	
$\pm 10$ MHz		-13		dBm	
COCHANNEL REJECTION					Desired signal 3 dB above the input sensitivity level (PER = 5%), CW interferer power level increased until PER = 5%, AFC enabled
Configuration 169.43125 MHz/2.4 kbps		-10		dB	
Configuration 169.41875 MHz/4.8 kbps		-10		dB	
CALIBRATED IMAGE REJECTION				dB	Desired signal 3 dB above the input sensitivity level (PER = 5%), CW interferer power level increased until PER = 5%, AFC enabled, image calibrated
Configuration 169.43125 MHz/2.4 kbps		55		dB	
ADJACENT CHANNEL POWER (ACP)					Spectrum analyzer settings: resolution bandwidth (RBW) = 100 Hz, video bandwidth (VBW) = 300 Hz PA1, output power = 13 dBm
Configuration 169.43125 MHz/2.4 kbps Adjacent Channel		-83		dBc	
Alternate Channel		-82		dBc	
Configuration 169.41875 MHz/4.8 kbps Adjacent Channel		-59		dBc	PA2, output power = 17 dBm
Alternate Channel		-81		dBc	
Configuration 169.46875 MHz/6.4 kbps Adjacent Channel		-68		dBc	PA1, output power = 13 dBm
Alternate Channel		-81		dBc	
OCCUPIED BANDWIDTH (OBW)					Occupied bandwidth is the bandwidth containing 99% of the total integrated power; spectrum analyzer settings: RBW = 100 Hz, VBW = 300 Hz
Configuration 169.43125 MHz/2.4 kbps		6.3		kHz	PA1, output power = 13 dBm
Configuration 169.41875 MHz/4.8 kbps		7.8		kHz	PA2, output power = 17 dBm
Configuration 169.46875 MHz/6.4 kbps		8.2		kHz	PA1, output power = 13 dBm
SPURIOUS EMISSIONS (EXCLUDING HARMONICS)					Measured conductively at antenna input; RF frequency = 169.43125 MHz
Receive					
<1 GHz		-58		dBm	
1 GHz to 4 GHz		-49		dBm	
Transmit					PA2, output power = 17 dBm, transmitting continuous carrier wave
<1 GHz		-75		dBc	
1 GHz to 4 GHz		-78		dBc	
HARMONIC EMISSIONS					Measured conductively at antenna input, transmitting continuous carrier wave; RF frequency = 169.43125 MHz PA2
17 dBm Output Power Second Harmonic		-81		dBc	
Third Harmonic		-90		dBc	
All Other Harmonics		<-90		dBc	

**433 MHz**

Unless otherwise noted, the configuration detailed in Table 8 is used to specify the performance of the ADF7030-1 in Table 9. All measurements are performed on the EV-ADF70301-460BZ evaluation board, unless otherwise noted. The EV-ADF70301-460BZ uses a separate transmit/receive match design and a 26 MHz TCXO reference.

**Table 8. 433 MHz Configurations**

Configuration Name	RF Frequency (MHz)	Data Rate (kbps)	Modulation	Frequency Deviation (kHz)	Channel Spacing (kHz)	IF Frequency (kHz)	Receiver BW (kHz)	Packet Setup for Packet Based Testing
433 MHz/50 kbps	433	50	2GFSK	25	200	154	127	Preamble = 0xAAAA, sync word = 0xF672, payload length = 16 bytes, CRC = 2 bytes

**Table 9. 433 MHz Specifications**

Parameter	Min	Typ	Max	Unit	Test Conditions/Comments
SENSITIVITY, PER Configuration 433 MHz/50 kbps		-108.2		dBm	At PER = 5%, AFC enabled, RF frequency error range = ±25 ppm
CHANNEL SELECTIVITY AND BLOCKING— BER-BASED TEST METHOD  Configuration 433 MHz/50 kbps Adjacent Channel (±200 kHz) Alternate Channel (±400 kHz) ±2 MHz ±10 MHz ±20 MHz		48 58 74 83 91		dB dB dB dB dB	Desired signal 3 dB above the input sensitivity level (BER = 0.1%), CW interferer power level increased until BER = 0.1%, image calibrated, AFC disabled
CHANNEL SELECTIVITY AND BLOCKING— PER BASED TEST METHOD  Configuration 433 MHz/50 kbps Adjacent Channel (±200 kHz) Alternate Channel (±400 kHz) ±2 MHz ±10 MHz		46 55 71.5 77		dB dB dB dB	Desired signal 3 dB above the input sensitivity level (PER = 5%), CW interferer power level increased until PER = 5%, image calibrated, AFC enabled
COCHANNEL REJECTION  Configuration 433 MHz/50 kbps		-10		dB	Desired signal 3 dB above the input sensitivity level (PER = 5%), CW interferer power level increased until PER = 5%, AFC enabled
CALIBRATED IMAGE REJECTION  Configuration 433 MHz/50 kbps		54		dB	Desired signal 3 dB above the input sensitivity level (PER = 5%), CW interferer power level increased until PER = 5%, AFC enabled, image calibrated
ACP Configuration 433 MHz/50 kbps		-59		dBc	Spectrum analyzer settings: RBW = 100 Hz, VBW = 300 Hz
OCCUPIED BANDWIDTH (OBW)  Configuration 433 MHz/50 kbps		86		kHz	Occupied bandwidth is the bandwidth containing 99% of the total integrated power; spectrum analyzer settings: RBW = 100 Hz, VBW = 300 Hz

<b>Parameter</b>	<b>Min</b>	<b>Typ</b>	<b>Max</b>	<b>Unit</b>	<b>Test Conditions/Comments</b>
SPURIOUS EMISSIONS (EXCLUDING HARMONICS)					Measured conductively at antenna port; RF frequency = 433 MHz  PA1, output power = 10 dBm, transmitting continuous carrier wave
Receive					
<1 GHz		-82		dBm	
1 GHz to 4 GHz		-47		dBm	
Transmit					
<1 GHz		-53		dBc	
1 GHz to 4 GHz		-76		dBc	
HARMONIC EMISSIONS					Measured conductively at antenna input, transmitting continuous carrier wave; RF frequency = 433 MHz, PA1, output power = 10 dBm
Second Harmonic		-64		dBc	
All Other Harmonics		<-90		dBc	

**450 MHz to 470 MHz**

Unless otherwise noted, the configuration detailed in Table 10 is used to specify the performance of the ADF7030-1 in Table 11. All measurements are performed on the EV-ADF70301-460BZ evaluation board, unless otherwise noted. The EV-ADF70301-460BZ uses a separate transmit/receive match design and a 26 MHz TCXO reference.

**Table 10. Configurations in the 450 MHz to 470 MHz Frequency Band**

Configuration Name	RF Frequency (MHz)	Data Rate (kbps)	Modulation	Frequency Deviation (kHz)	Channel Spacing (kHz)	IF Frequency (kHz)	Receiver BW (kHz)	Packet Setup for Packet Based Testing
460 MHz/7.2 kbps	460	7.2	2GFSK	2.0	12.5	81.25	11.7	Preamble = 0xAAAA, sync word = 0xF672, payload length = 23 bytes, CRC = 2 bytes

**Table 11. Specifications in the 450 MHz to 470 MHz Frequency Band**

Parameter	Min	Typ	Max	Unit	Test Conditions/Comments
SENSITIVITY, PER Configuration 460 MHz/7.2 kbps		-116		dBm	At PER = 5%, AFC enabled, RF frequency error range = ±3.9 ppm
CHANNEL SELECTIVITY AND BLOCKING— BER-BASED TEST METHOD  Configuration 460 MHz/7.2 kbps Adjacent Channel (±12.5 kHz) Alternate Channel (±25 kHz) ±2 MHz ±10 MHz ±20 MHz		54 61 84 92 98		dB dB dB dB dB	Desired signal 3 dB above the input sensitivity level (BER = 0.1%), CW interferer power level increased until BER = 0.1%, image calibrated, AFC disabled
CHANNEL SELECTIVITY AND BLOCKING— PER-BASED TEST METHOD  Configuration 460 MHz/7.2 kbps Adjacent Channel (±12.5 kHz) Alternate Channel (±25 kHz) ±2 MHz ±10 MHz		38 57 80 85		dB dB dB dB	Desired signal 3 dB above the input sensitivity level (PER = 5%), CW interferer power level increased until PER = 5%, image calibrated, AFC enabled
COCHANNEL REJECTION  Configuration 460 MHz/7.2 kbps		10		dB	Desired signal 3 dB above the input sensitivity level (PER = 5%), CW interferer power level increased until PER = 5%, AFC enabled
CALIBRATED IMAGE REJECTION  Configuration 460 MHz/7.2 kbps		51		dB	Desired signal 3 dB above the input sensitivity level (PER = 5%), CW interferer power level increased until PER = 5%, AFC enabled, image calibrated
ACP Configuration 460 MHz/7.2 kbps		-45		dBc	Spectrum analyzer settings: RBW = 100 Hz, VBW = 300 Hz
OBW  Configuration 460 MHz/7.2 kbps		7.7		kHz	Occupied bandwidth is the bandwidth containing 99% of the total integrated power; spectrum analyzer settings: RBW = 100 Hz, VBW = 300 Hz

Parameter	Min	Typ	Max	Unit	Test Conditions/Comments
SPURIOUS EMISSIONS (EXCLUDING HARMONICS)					Measured conductively at antenna port; RF frequency = 460 MHz  PA2, output power = 17 dBm, transmitting continuous carrier wave
Receive					
<960 MHz		-57		dBm	
960 MHz to 12.7 GHz		-66		dBm	
Transmit					
<960 MHz		-59		dBc	
960 MHz to 12.7 GHz		-76		dBc	
HARMONIC EMISSIONS					Measured conductively at antenna port, transmitting continuous carrier wave; RF frequency = 460 MHz, output power = 17 dBm, PA2
Second Harmonic		-60		dBc	
All Other Harmonics		< -90		dBc	

**863 MHz to 876 MHz**

Unless otherwise noted, the configurations detailed in Table 12 are used to specify the performance of the ADF7030-1 in Table 13. All measurements are performed on the EV-ADF70301-868BZ evaluation board, unless otherwise noted. The EV-ADF70301-868BZ uses a separate transmit/receive match design and a 26 MHz TCXO reference.

**Table 12. Configurations in the 863 MHz to 876 MHz Frequency Band**

Configuration Name	RF Frequency (MHz)	Data Rate (kbps)	Modulation	Frequency Deviation (kHz)	Channel Spacing (kHz)	IF Frequency (kHz)	Receiver BW (kHz)	Packet Setup for Packet Based Testing
868 MHz/4.8 kbps	868	4.8	2GFSK	2.4	12.5	81.25	10.6	Preamble = 0xAAAA, sync word = 0xF672, payload length = 23 bytes, CRC = 2 bytes
868 MHz/100 kbps	868	100	2FSK	50	500	241	231	Preamble = 0xAAAAAAAA, sync word = 0x543D54CD, payload length = 20 bytes, CRC = 2 bytes

**Table 13. Specifications in the 863 MHz to 876 MHz Frequency Band**

Parameter	Min	Typ	Max	Unit	Test Conditions/Comments
SENSITIVITY, PER					
Configuration 868 MHz/4.8 kbps		-118.5		dBm	At PER = 5%, AFC enabled, RF frequency error range = $\pm 3$ ppm
Configuration 868 MHz/100 kbps		-106		dBm	At PER = 5%, AFC enabled, RF frequency error range = $\pm 25$ ppm, data rate error range = $\pm 100$ ppm, frequency deviation error range = $\pm 25\%$
CHANNEL SELECTIVITY AND BLOCKING— BER-BASED TEST METHOD					Desired signal 3 dB above the input sensitivity level (BER = 0.1%), CW interferer power level increased until BER = 0.1%, image calibrated, AFC disabled
Configuration 868 MHz/4.8 kbps					
Adjacent Channel ( $\pm 12.5$ kHz)		56		dB	
Alternate Channel ( $\pm 25$ kHz)		56		dB	
$\pm 2$ MHz		78		dB	
$\pm 10$ MHz		87		dB	
$\pm 20$ MHz		98		dB	
CHANNEL SELECTIVITY AND BLOCKING— PER-BASED TEST METHOD					Desired signal 3 dB above the input sensitivity level (PER = 5%), CW interferer power level increased until PER = 5%, image calibrated, AFC enabled
Configuration 868 MHz/4.8 kbps					
Adjacent Channel ( $\pm 12.5$ kHz)		47		dB	
Alternate Channel ( $\pm 25$ kHz)		55		dB	
$\pm 2$ MHz		79		dB	
$\pm 10$ MHz		90		dB	
Configuration 868 MHz/100 kbps					
Adjacent Channel ( $\pm 500$ kHz)		44		dB	
Alternate Channel ( $\pm 1000$ kHz)		59		dB	
$\pm 2$ MHz		65		dB	
$\pm 10$ MHz		76		dB	
COCHANNEL REJECTION					Desired signal 3 dB above the input sensitivity level (PER = 5%), CW interferer power level increased until PER = 5%, AFC enabled
Configuration 868 MHz/4.8 kbps		-10		dB	
Configuration 868 MHz/100 kbps		-10		dB	



Parameter	Min	Typ	Max	Unit	Test Conditions/Comments
UNCALIBRATED IMAGE REJECTION					Desired signal 3 dB above the input sensitivity level (PER = 5%), CW interferer power level increased until PER = 5%, AFC enabled
Configuration 868 MHz/4.8 kbps		35		dB	
Configuration 868 MHz/100 kbps		35		dB	
ACP					Spectrum analyzer settings: RBW = 100 Hz, VBW = 300 Hz
Configuration 868 MHz/4.8 kbps		-65		dBc	
Configuration 868 MHz/100 kbps		-41		dBc	
OBW					Occupied bandwidth is the bandwidth containing 99% of the total integrated power; spectrum analyzer settings: RBW = 100 Hz, VBW = 300 Hz
Configuration 868 MHz/4.8 kbps		7.8		kHz	
Configuration 868 MHz/100 kbps		226		kHz	
SPURIOUS EMISSIONS (EXCLUDING HARMONICS)					Measured conductively at antenna input; RF Frequency = 868 MHz
Receive					
<1 GHz		-58		dBm	
1 GHz to 4 GHz		-46		dBm	
Transmit					PA2, 17dBm output power, transmitting continuous carrier wave
<1 GHz		-74		dBc	
1 GHz to 4 GHz		-77		dBc	
HARMONIC EMISSIONS					Measured conductively at antenna input, transmitting continuous carrier wave; RF frequency = 868 MHz
13 dBm Output Power					PA1
Second Harmonic		-50		dBc	
Third Harmonic		-78		dBc	
Seventh Harmonic		-88		dBc	
All Other Harmonics		<-90		dBc	
17 dBm Output Power					PA2
Second Harmonic		-55		dBc	
Third Harmonic		-73		dBc	
All Other Harmonics		<-90		dBc	

**902 MHz to 928 MHz**

Unless otherwise noted, the configurations detailed in Table 14 are used to specify the performance of the ADF7030-1 in Table 15. All measurements are performed on the EV-ADF70301-868BZ evaluation board, unless otherwise noted. The EV-ADF70301-868BZ uses a separate transmit/receive match design and a 26 MHz TCXO reference.

**Table 14. Configurations in the 902 MHz to 928 MHz Frequency Band**

Configuration Name	RF Frequency (MHz)	Data Rate (kbps)	Modulation	Frequency Deviation (kHz)	Channel Spacing (kHz)	IF Frequency (kHz)	Receiver BW (kHz)	Packet Setup for Packet Based Testing
915 MHz/ 50 kbps	915	50	2GFSK	25	200	154	127	Preamble = 0xAAAAAAAA, sync word = 0x904E, payload length = 100 bytes, CRC = 2 bytes
915 MHz/ 150 kbps	915	150	2GFSK	37.5	400	336	250	Preamble = 0xAAAAAAAAAAAAAAAAAAAAAA, sync word = 0xFF7D7F5D, payload length = 100 bytes, CRC = 2 bytes
915 MHz/ 300 kbps	915	300	2GFSK	120	600	540	530	Preamble = 0xAAAAAAAA, sync word = 0xF672, payload length = 23 bytes, CRC = 2 bytes

**Table 15. 902 MHz to 928 MHz Specifications**

Parameter	Min	Typ	Max	Unit	Test Conditions/Comments
2GFSK SENSITIVITY, PER					
Configuration 915 MHz/50 kbps		-108.2		dBm	At PER = 5%, FEC disabled, AFC enabled, RF frequency error range = $\pm 40$ ppm
Configuration 915 MHz/150 kbps		-100.5		dBm	At PER = 5%, FEC disabled, AFC enabled, RF frequency error range = $\pm 40$ ppm
Configuration 915 MHz/300 kbps		-102		dBm	At PER = 5%, AFC disabled, RF frequency error range = $\pm 11.5$ ppm
CHANNEL SELECTIVITY AND BLOCKING— BER-BASED TEST METHOD					Desired signal 3 dB above the input sensitivity level (BER = 0.1%), CW interferer power level increased until BER = 0.1%, AFC disabled
Configuration 915 MHz/150 kbps					
Adjacent Channel ( $\pm 400$ kHz)		46		dB	
Alternate Channel ( $\pm 800$ kHz)		56		dB	
$\pm 2$ MHz		66		dB	
$\pm 10$ MHz		77		dB	
$\pm 20$ MHz		83		dB	
CHANNEL SELECTIVITY AND BLOCKING— PER-BASED TEST METHOD					Desired signal 3 dB above the input sensitivity level (PER = 5%), CW interferer power level increased until PER = 5%, image calibrated
Configuration 915 MHz/50 kbps					FEC disabled, AFC enabled
Adjacent Channel ( $\pm 200$ kHz)		44.5		dB	
Alternate Channel ( $\pm 400$ kHz)		52		dB	
$\pm 2$ MHz		67		dB	
$\pm 10$ MHz		77		dB	
Configuration 915 MHz/150 kbps					FEC disabled, AFC enabled
Adjacent Channel ( $\pm 400$ kHz)		43.5		dB	
Alternate Channel ( $\pm 800$ kHz)		44		dB	
$\pm 2$ MHz		60.5		dB	
$\pm 10$ MHz		70		dB	
Configuration 915 MHz/300 kbps					AFC disabled
Adjacent Channel ( $\pm 600$ kHz)		28		dB	
Alternate Channel ( $\pm 1200$ kHz)		33		dB	
$\pm 2$ MHz		62		dB	
$\pm 10$ MHz		72		dB	

Parameter	Min	Typ	Max	Unit	Test Conditions/Comments
COCHANNEL REJECTION					Desired signal 3 dB above the input sensitivity level (PER = 5%), CW interferer power level increased until PER = 5%
Configuration 915 MHz/50 kbps		-10		dB	
Configuration 915 MHz/150 kbps		-10		dB	
Configuration 915 MHz/300 kbps		-10		dB	
UNCALIBRATED IMAGE REJECTION					Desired signal 3 dB above the input sensitivity level (PER = 5%), CW interferer power level increased until PER = 5%
Configuration 915 MHz/50 kbps		35		dB	
Configuration 915 MHz/150 kbps		35		dB	
Configuration 915 MHz/300 kbps		35		dB	
ACP					
Configuration 915 MHz/50 kbps Adjacent Channel ( $\pm 200$ kHz) Alternate Channel ( $\pm 400$ kHz)		-55		dBc	Spectrum analyzer settings: RBW = 300 Hz, VBW = 1 kHz
Configuration 915 MHz/150 kbps Adjacent Channel ( $\pm 400$ kHz) Alternate Channel ( $\pm 800$ kHz)		-53		dBc	Spectrum analyzer settings: RBW = 300 Hz, VBW = 1 kHz
Configuration 915 MHz/300 kbps Adjacent Channel ( $\pm 600$ kHz) Alternate Channel ( $\pm 1200$ kHz)		-30.5		dBc	Spectrum analyzer settings: RBW = 300 Hz, VBW = 1 kHz
Configuration 915 MHz/300 kbps Alternate Channel ( $\pm 1200$ kHz)		-66		dBc	
OCCUPIED BANDWIDTH					Occupied bandwidth is the bandwidth containing 99% of the total integrated power
Configuration 915 MHz/50 kbps		85		kHz	Spectrum analyzer settings: RBW = 300 Hz, VBW = 1 kHz
Configuration 915 MHz/150 kbps		167		kHz	Spectrum analyzer settings: RBW = 300 Hz, VBW = 1 kHz
Configuration 915 MHz/300 kbps		475		kHz	Spectrum analyzer settings: RBW = 300 Hz, VBW = 1 kHz
SPURIOUS EMISSIONS (EXCLUDING HARMONICS)					Measured conductively at antenna input; RF frequency = 915 MHz
Receive					
<960 MHz		-82		dBm	
960 MHz to 12.7 GHz		-47		dBm	
Transmit					PA2, output power = 17 dBm, transmitting continuous carrier wave
<960 MHz		-71		dBc	
960 MHz to 12.7 GHz		-73		dBc	
HARMONIC EMISSIONS					Measured conductively at antenna input, transmitting continuous carrier wave; RF frequency = 915 MHz
13 dBm Output Power					PA1
Second Harmonic		-53		dBc	
Third Harmonic		-83		dBc	
Seventh Harmonic		-88		dBc	
All Other Harmonics		<-90		dBc	
17 dBm Output Power					PA2
Second Harmonic		-54		dBc	
Third Harmonic		-66		dBc	
All Other Harmonics		<-90		dBc	

**EXTERNAL 26 MHz OSCILLATOR**

The ADF7030-1 requires a 26 MHz reference clock. This reference can be a 26 MHz crystal oscillator operating in parallel mode and connected between the HFXTALP and HFXTALN pins. Alternatively, a 26 MHz TCXO can be dc-coupled to the HFXTALN input. A TCXO is typically used in narrow-band applications where the transmit and receive RF frequency must meet accuracies not supported by a crystal oscillator.

Table 16.

Parameter	Min	Typ	Max	Unit	Test Conditions/Comments
DC-COUPLED TCXO					HFXTALN pin, clipped sine wave
TCXO Frequency		26		MHz	
Peak-to-Peak Voltage Level	0.8		1.8	V	
Voltage Level with Respect to Ground	-0.1		+1.9	V	
Duty Cycle	40		60	%	
CRYSTAL OSCILLATOR					Parallel resonant crystal
Crystal Frequency		26		MHz	
Maximum Crystal ESR			50	$\Omega$	
Crystal Oscillator Load Capacitance		12		pF	
HFXTALN, HFXTALP Pin Capacitance in Parallel with Crystal Oscillator		5		pF	

**LOW FREQUENCY OSCILLATOR**

Table 17.

Parameter	Min	Typ	Max	Unit	Test Conditions/Comments
26 kHz INTERNAL RC OSCILLATOR					After calibration After calibration at 25°C
Frequency		26		kHz	
Frequency Accuracy		0.2		%	
Frequency Drift					
Temperature Coefficient		0.3		%/°C	
Voltage Coefficient		0.5		%/V	
Calibration Time		30		ms	
32 kHz EXTERNAL OSCILLATOR					
Frequency		32.768		kHz	
Start-Up Time		1.45		sec	

**TEMPERATURE SENSOR**

Table 18.

Parameter	Min	Typ	Max	Unit	Test Conditions/Comments
TEMPERATURE SENSOR					
Range	-40		+85	°C	
Accuracy		±5		°C	T <sub>A</sub> = -40°C to +85°C; calibrated at 25°C

## DIGITAL INPUT/OUTPUT

Table 19.

Parameter	Symbol	Min	Typ	Max	Unit	Test Conditions/Comments
LOGIC INPUTS						
Input Voltage						
High	$V_{INH}$	$0.7 \times V_{DD}$			V	
Low	$V_{INL}$			$0.2 \times V_{DD}$	V	
Input Capacitance	$C_{IN}$		3.6		pF	
LOGIC OUTPUTS						
Output Voltage						
High	$V_{OH}$	$V_{DD} - 0.4$			V	$I_{OH} = 500 \mu A$
Low	$V_{OL}$			0.4	V	$I_{OL} = 500 \mu A$
Maximum GPIO Drive Strength for $V_{OH}$			2		mA	
Maximum GPIO Drive Strength for $V_{OL}$			2		mA	

## DIGITAL TIMING

Table 20. SPI Interface Timing

Parameter	Description	Min	Typ	Max	Unit
$t_1$	Falling edge to MISO setup time			15	ns
$t_2$	$\overline{CS}$ low to SCLK setup time	40			ns
$t_3$	SCLK high time	40			ns
$t_4$	SCLK low time	40			ns
$t_5$	SCLK period	80			ns
$t_6$	SCLK falling edge to MISO delay			10	ns
$t_7$	MOSI to SCLK rising edge setup time	5			ns
$t_8$	MOSI to SCLK rising edge hold time	5			ns
$t_9$	SCLK falling edge to $\overline{CS}$ hold time	40			ns
$t_{10}$	$\overline{CS}$ high time	80			ns
$t_{11}$	$\overline{CS}$ low to MISO high wake-up time		92		$\mu s$
$t_{12}$	MISO high to SCLK setup time	SCLK low time <sup>1</sup>			$\mu s$
$t_{13}$	$\overline{RST}$ low time	2			$\mu s$

<sup>1</sup> The minimum for  $t_{12}$  changes with the SCLK frequency.

Timing Diagrams

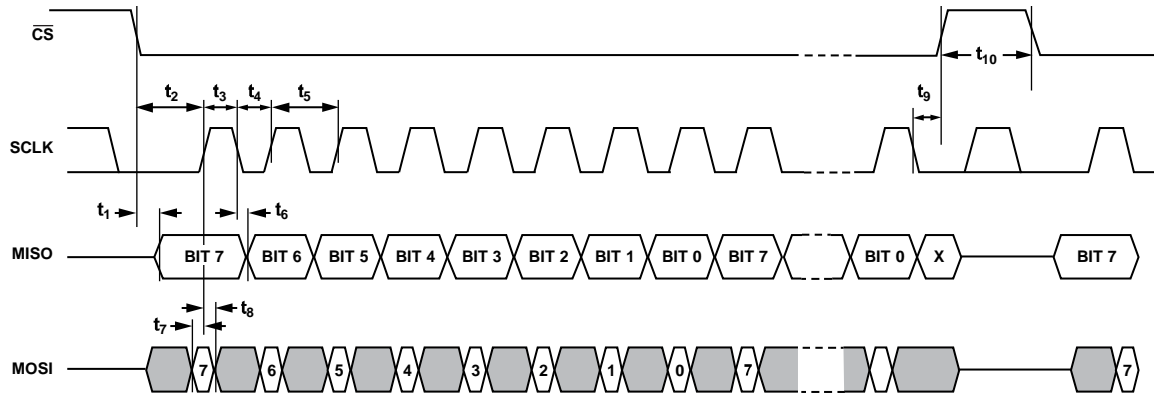

Figure 2. SPI Interface Timing

14373-002

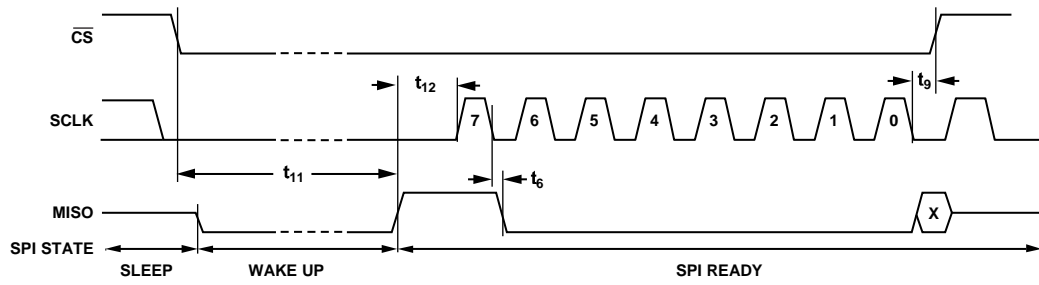

Figure 3. PHY\_SLEEP to SPI Ready State Timing

14373-003

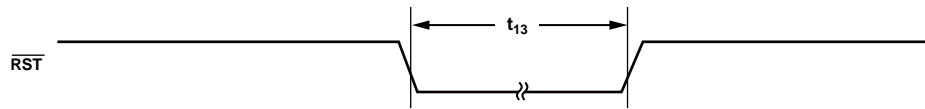

Figure 4. Reset Pin ( $\overline{RST}$ ) Timing

14373-004

## ABSOLUTE MAXIMUM RATINGS

$T_A = 25^\circ\text{C}$ , unless otherwise noted. All VBATx pins must be tied together. The LNAIN1 and LNAIN2 inputs must be ac-coupled.

Table 21.

Parameter	Rating
Supply Pins	
VBAT1, VBAT2, VBAT3, VBAT4, VBAT5, VBAT6 to Ground	-0.3 V to +3.9 V
LNAIN1, LNAIN2	-0.3 V to +1.98 V
PAOUT1, PAOUT2	-0.3 V to +3.9 V
HFXTALP, HFXTALN	-0.3 V to +1.98 V
CLF	-0.3 V to +1.98 V
CREG1, CREG2, CREG4, CREG5, CREG6, CREG7	-0.3 V to +1.98 V
CREG3	-0.3 V to +3.9 V
Digital Inputs/Outputs, GPIOx	-0.3 V to +3.9 V
MOSI, MISO, SCLK, $\overline{\text{CS}}$ , $\overline{\text{RST}}$	-0.3 V to +3.9 V
Industrial Operating Temperature Range	-40°C to +85°C
Storage Temperature Range	-65°C to +125°C
Maximum Junction Temperature	150°C
$\theta_{JA}$ Thermal Impedance	26°C/W
ESD Rating, Human Body Model (HBM)	
40-Lead LFCSP Package	
LNAIN1, LNAIN2, PAOUT1, PAOUT2	±250 V
All Other Pins	±2 kV
48-Lead LQFP Package	
LNAIN1, LNAIN2, PAOUT1, PAOUT2	±250 V
All Other Pins	±2 kV
ESD Rating, Field Induced Charged Device Model (FICDM)	
40-Lead LFCSP Package	
LNAIN1, LNAIN2, PAOUT1, PAOUT2	±1250 V
All Other Pins	±1250 V
48-Lead LQFP Package	
LNAIN1, LNAIN2, PAOUT1, PAOUT2	±1250 V
All Other Pins	±1250 V
Reflow Soldering	
Peak Temperature	260°C
Time at Peak Temperature	40 sec

Stresses at or above those listed under Absolute Maximum Ratings may cause permanent damage to the product. This is a stress rating only; functional operation of the product at these or any other conditions above those indicated in the operational section of this specification is not implied. Operation beyond the maximum operating conditions for extended periods may affect product reliability.

Connect the exposed pad of the 40-lead LFCSP device to ground.

This device is a high performance, RF integrated circuit with an ESD rating as indicated in Table 21; it is ESD sensitive. Take proper precautions for handling and assembly.

### ESD CAUTION



**ESD (electrostatic discharge) sensitive device.** Charged devices and circuit boards can discharge without detection. Although this product features patented or proprietary protection circuitry, damage may occur on devices subjected to high energy ESD. Therefore, proper ESD precautions should be taken to avoid performance degradation or loss of functionality.

# PIN CONFIGURATIONS AND FUNCTION DESCRIPTIONS

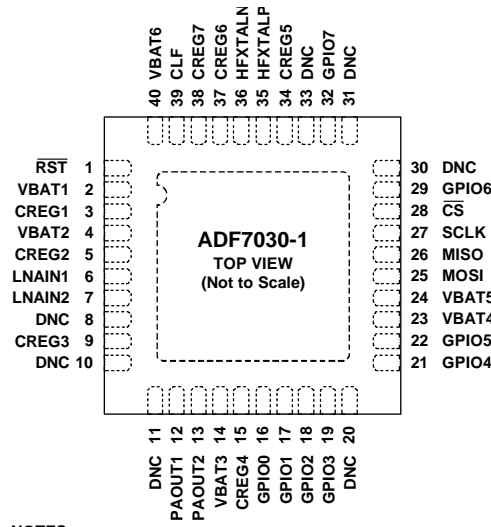

NOTES  
 1. DNC = DO NOT CONNECT. DO NOT CONNECT TO THIS PIN.  
 2. CONNECT THE EXPOSED PAD TO GROUND.

Figure 5. 40-Lead LFCSP Pin Configuration

Table 22. 40-Lead LFCSP Pin Function Descriptions

Pin No.	Mnemonic	Description
1	RST	External Reset, Active Low.
2	VBAT1	Power Supply Pin 1 to the Internal Regulators.
3	CREG1	Regulator Output 1. Place a 220 nF capacitor between this pin and ground for regulator stability and noise rejection. Also, place a 1.2 nF capacitor between this pin and the CLF pin.
4	VBAT2	Power Supply Pin 2 to the Internal Regulators.
5	CREG2	Regulator Output 2. Place a 220 nF capacitor between this pin and ground for regulator stability and noise rejection.
6	LNAIN1	LNA Input 1.
7	LNAIN2	LNA Input 2.
8	DNC	Do Not Connect. Do not connect to this pin.
9	CREG3	Regulator Output 3. Connect this pin to the PA choke inductor to provide bias to the PA. Place a 220 nF capacitor between this pin and ground for regulator stability and noise rejection.
10	DNC	Do Not Connect. Do not connect to this pin.
11	DNC	Do Not Connect. Do not connect to this pin.
12	PAOUT1	Single-Ended PA1 Output.
13	PAOUT2	Single-Ended PA2 Output.
14	VBAT3	Power Supply Pin 3 to the Internal Regulators.
15	CREG4	Regulator Output 4. Place a 220 nF capacitor between this pin and ground for regulator stability and noise rejection.
16	GPIO0	Digital GPIO Pin 0.
17	GPIO1	Digital GPIO Pin 1.
18	GPIO2	Digital GPIO Pin 2.
19	GPIO3	Digital GPIO Pin 3.
20	DNC	Do Not Connect. Do not connect to this pin.
21	GPIO4	Digital GPIO Pin 4.
22	GPIO5	Digital GPIO Pin 5.
23	VBAT4	Power Supply Pin 4 to the Internal Regulators.
24	VBAT5	Power Supply Pin 5 to the Internal Regulators.
25	MOSI	Serial Port Master Output/Slave Input.
26	MISO	Serial Port Master Input/Slave Output.
27	SCLK	Serial Port Clock.
28	CS	Chip Select (Active Low). A pull-up resistor of 100 kΩ to V <sub>DD</sub> is recommended to prevent the host processor from inadvertently waking the ADF7030-1 from sleep.



Pin No.	Mnemonic	Description
29	GPIO6	Digital GPIO Pin 6.
30	DNC	Do Not Connect. Do not connect to this pin.
31	DNC	Do Not Connect. Do not connect to this pin.
32	GPIO7	Digital GPIO Pin 7.
33	DNC	Do Not Connect. Do not connect to this pin.
34	CREG5	Regulator Output 5. Place a 220 nF capacitor between this pin and ground for regulator stability and noise rejection.
35	HFX TALP	Positive Reference Input. If a 26 MHz TCXO is used as the external reference, do not connect this pin. If a 26 MHz XTAL is used as the reference, connect this pin to the XTAL.
36	HFX TALN	Negative Reference Input. If a 26 MHz TCXO is used as the external reference, connect this pin to the TCXO output. If a 26 MHz XTAL is used as the reference, connect this pin to the XTAL.
37	CREG6	Regulator Output 6. Place a 220 nF capacitor between this pin and ground for regulator stability and noise rejection.
38	CREG7	Regulator Output 7. Place a 220 nF capacitor between this pin and ground for regulator stability and noise rejection.
39	CLF	External Loop Filter Capacitor. Place a 1.2 nF capacitor between this pin and the CREG1 pin.
40	VBAT6	Power Supply Pin 6 to the Internal Regulators.
	EPAD	Exposed Pad. Connect the exposed pad to ground.

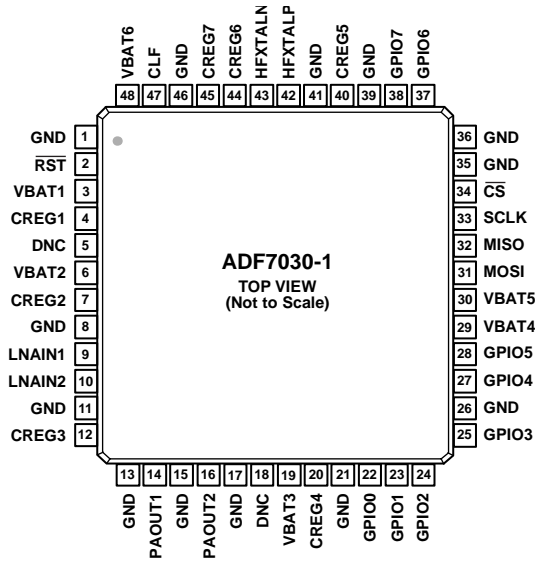

NOTES  
 1. DNC = DO NOT CONNECT. DO NOT CONNECT TO THIS PIN.

14372-008

Figure 6. 48-Lead LQFP Pin Configuration

Table 23. 48-Lead LQFP Pin Function Descriptions

Pin No.	Mnemonic	Description
1	GND	Connection to Ground.
2	RST	External Reset, Active Low.
3	VBAT1	Power Supply Pin 1 to the Internal Regulators.
4	CREG1	Regulator Output 1. Place a 220 nF capacitor between this pin and ground for regulator stability and noise rejection. Also, place a 1.2 nF capacitor between this pin and the CLF pin.
5	DNC	Do Not Connect. Do not connect to this pin.
6	VBAT2	Power Supply Pin 2 to the Internal Regulators.
7	CREG2	Regulator Output 2. Place a 220 nF capacitor between this pin and ground for regulator stability and noise rejection.
8	GND	Connection to Ground.
9	LNAIN1	LNA Input 1.
10	LNAIN2	LNA Input 2.
11	GND	Connection to Ground.
12	CREG3	Regulator Output 3. Connect this pin to the PA choke inductor to provide bias to the PA. Place a 220 nF capacitor between this pin and ground for regulator stability and noise rejection.
13	GND	Connection to Ground.
14	PAOUT1	Single-Ended PA1 Output.
15	GND	Connection to Ground.
16	PAOUT2	Single-Ended PA2 Output.
17	GND	Connection to Ground.
18	DNC	Do Not Connect. Do not connect to this pin.
19	VBAT3	Power Supply Pin 3 to the Internal Regulators.
20	CREG4	Regulator Output 4. Place a 220 nF capacitor between this pin and ground for regulator stability and noise rejection.
21	GND	Connection to Ground.
22	GPIO0	Digital GPIO Pin 0.
23	GPIO1	Digital GPIO Pin 1.
24	GPIO2	Digital GPIO Pin 2.
25	GPIO3	Digital GPIO Pin 3.
26	GND	Connection to Ground.
27	GPIO4	Digital GPIO Pin 4.
28	GPIO5	Digital GPIO Pin 5.
29	VBAT4	Power Supply Pin 4 to the Internal Regulators.
30	VBAT5	Power Supply Pin 5 to the Internal Regulators.

Pin No.	Mnemonic	Description
31	MOSI	Serial Port Master Output/Slave Input.
32	MISO	Serial Port Master Input/Slave Output.
33	SCLK	Serial Port Clock.
34	$\overline{\text{CS}}$	Chip Select (Active Low). A pull-up resistor of 100 k $\Omega$ to V <sub>DD</sub> is recommended to prevent the host processor from inadvertently waking the <a href="#">ADF7030-1</a> from sleep.
35	GND	Connection to Ground.
36	GND	Connection to Ground.
37	GPIO6	Digital GPIO Pin 6.
38	GPIO7	Digital GPIO Pin 7.
39	GND	Connection to Ground.
40	CREG5	Regulator Output 5. Place a 220 nF capacitor between this pin and ground for regulator stability and noise rejection.
41	GND	Connection to Ground.
42	HFXTALP	Positive Reference Input. If a 26 MHz TCXO is used as the external reference, do not connect this pin. If a 26 MHz XTAL is used as the reference, connect this pin to the XTAL.
43	HFXTALN	Negative Reference Input. If a 26 MHz TCXO is used as the external reference, connect this pin to the TCXO output. If a 26 MHz XTAL is used as the reference, connect this pin to the XTAL.
44	CREG6	Regulator Output 6. Place a 220 nF capacitor between this pin and ground for regulator stability and noise rejection.
45	CREG7	Regulator Output 7. Place a 220 nF capacitor between this pin and ground for regulator stability and noise rejection.
46	GND	Connection to Ground.
47	CLF	External Loop Filter Capacitor. Place a 1.2 nF capacitor between this pin and the CREG1 pin.
48	VBAT6	Power Supply Pin 6 to the Internal Regulators.

# TYPICAL PERFORMANCE CHARACTERISTICS

## 169 MHZ—RECEIVE

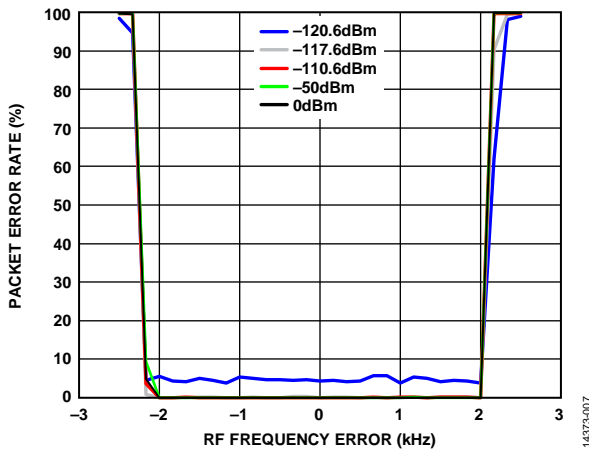

Figure 7. Packet Error Rate vs. RF Frequency Error and RF Input Power, Configuration 169.43125 MHz/2.4 kbps; AFC Enabled;  $V_{DD} = 3.0 V$ ;  $T_A = 25^\circ C$

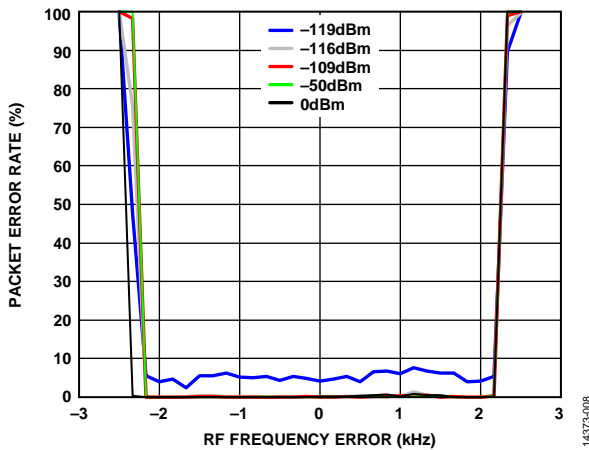

Figure 8. Packet Error Rate vs. RF Frequency Error and RF Input Power, Configuration 169.43125 MHz/4.8 kbps; AFC Enabled;  $V_{DD} = 3.0 V$ ;  $T_A = 25^\circ C$

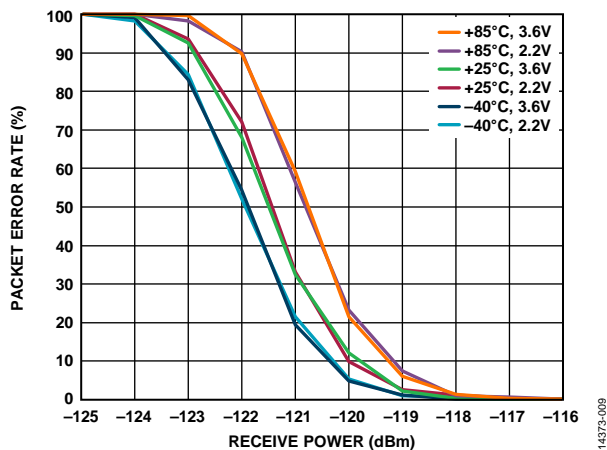

Figure 9. Packet Error Rate vs. RF Input Power, Temperature and VDD Configuration 169.43125 MHz/2.4 kbps

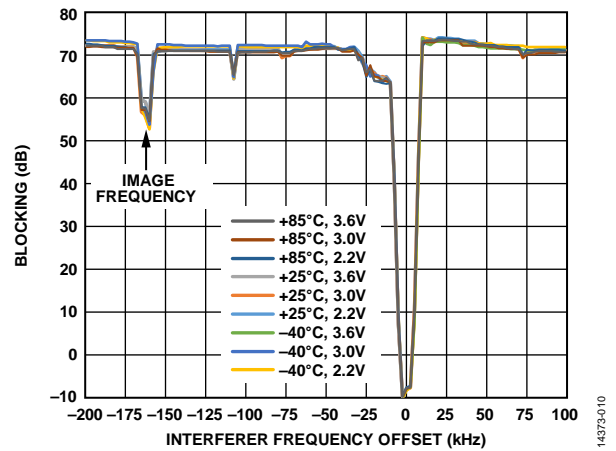

Figure 10. Receiver Close-In Blocking vs. Interferer Frequency Offset, Temperature, and  $V_{DD}$ ; Configuration 169.43125 MHz/2.4 kbps; Unmodulated Interferer; Desired Signal 3 dB Above the Sensitivity Level of BER = 0.1%; BER-Based Test

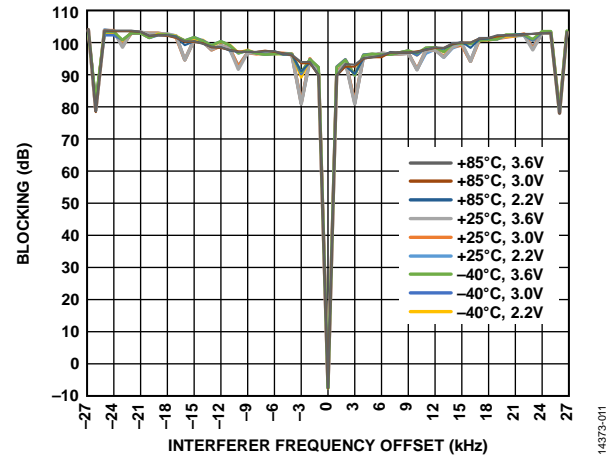

Figure 11. Receiver Wideband Blocking vs. Interferer Frequency Offset, Temperature, and  $V_{DD}$ ; Configuration 169.43125 MHz/2.4 kbps; Unmodulated Interferer; Desired Signal 3 dB Above the Sensitivity Level of BER = 0.1%; BER-Based Test

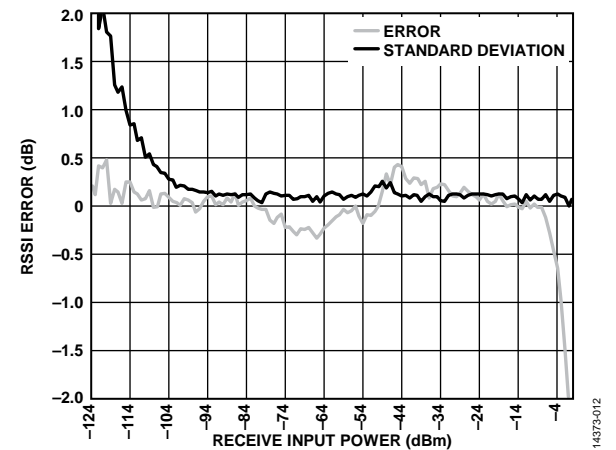
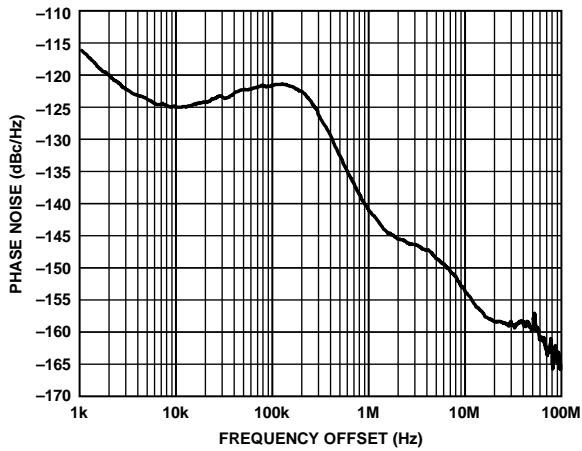

Figure 12. Packet RSSI Error vs. Rx Input Power with One-Point Calibration at  $-50 \text{ dBm}$ ,  $V_{DD} = 3.0 V$ ,  $T_A = 25^\circ C$ , Configuration 169.43125 MHz/2.4 kbps (Error is Based on the Mean RSSI of 100 Packets)

169 MHz—TRANSMIT



14373-014

Figure 13. Phase Noise vs. Frequency Offset, RF Frequency = 169.43125 MHz, PA2 Output Power = 17 dBm, V<sub>DD</sub> = 3.0 V, T<sub>A</sub> = 25°C

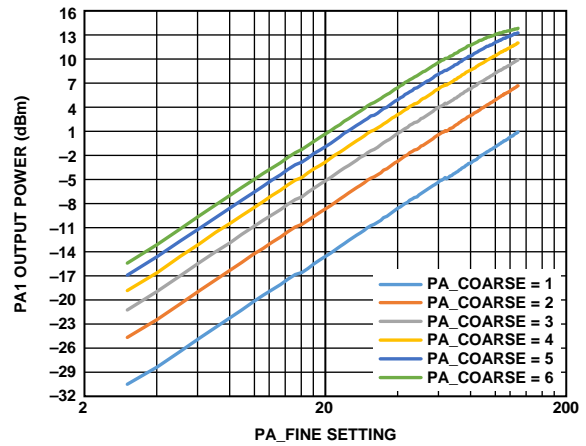

14373-017

Figure 16. PA1 Output Power vs. PA\_FINE Setting and PA\_COARSE Setting with PA\_FINE on a Log Scale, RF Frequency = 169.43125 MHz, V<sub>DD</sub> = 3.0 V, T<sub>A</sub> = 25°C

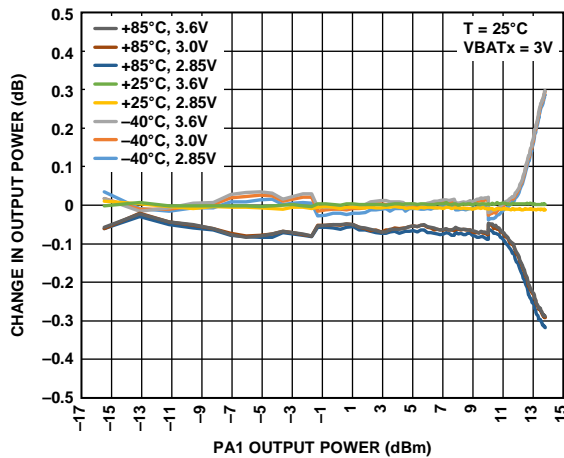

14373-015

Figure 14. Change in PA1 Output Power vs. Temperature, and V<sub>DD</sub> with PA\_COARSE = 6, RF Frequency = 169.43125 MHz; Variation Above 11 dBm Can Be Improved by Matching the PA for Higher Output Power

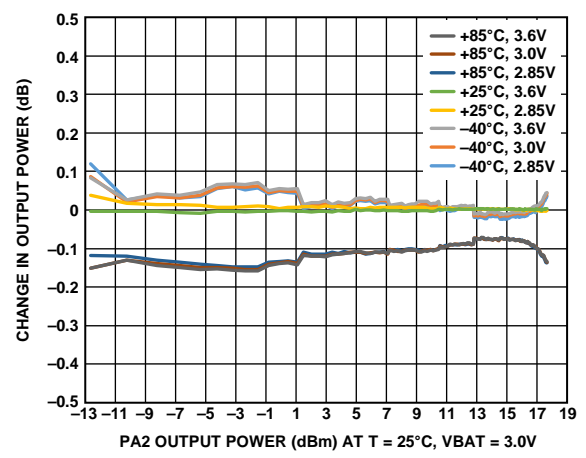

14373-018

Figure 17. Change in PA2 Output Power vs. Temperature, and V<sub>DD</sub> with PA\_COARSE = 10, PAOLDO\_VOUT\_CON = 15, RF Frequency = 169.43125 MHz

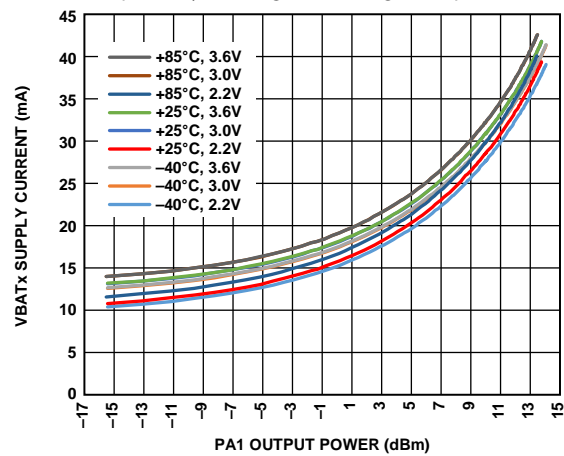

14373-016

Figure 15. VBATx Supply Current vs. PA1 Output Power, Temperature, and V<sub>DD</sub> with PA\_COARSE = 6, RF Frequency = 169.43125 MHz

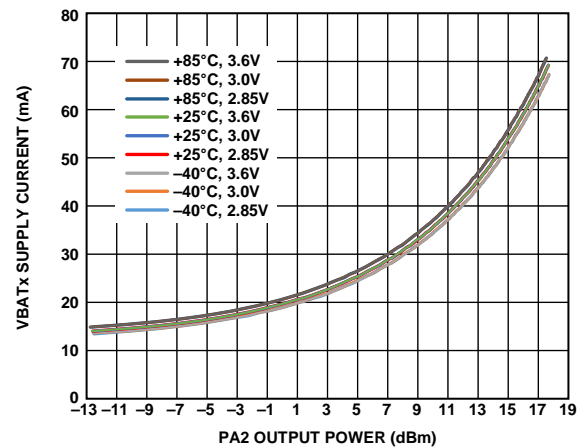

14373-019

Figure 18. VBATx Supply Current vs. PA2 Output Power, Temperature, and V<sub>DD</sub>, PA\_COARSE = 10, PAOLDO\_VOUT\_CON = 15, RF Frequency = 169.43125 MHz

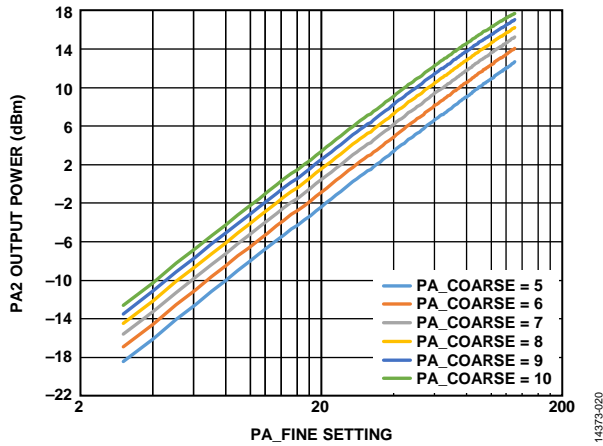

Figure 19. PA2 Output Power vs. PA\_FINE Setting and PA\_COARSE Setting with PA\_FINE on a Logarithmic Scale,  $V_{DD} = 3.0\text{ V}$ ,  $T_A = 25^\circ\text{C}$ , RF Frequency = 169 MHz

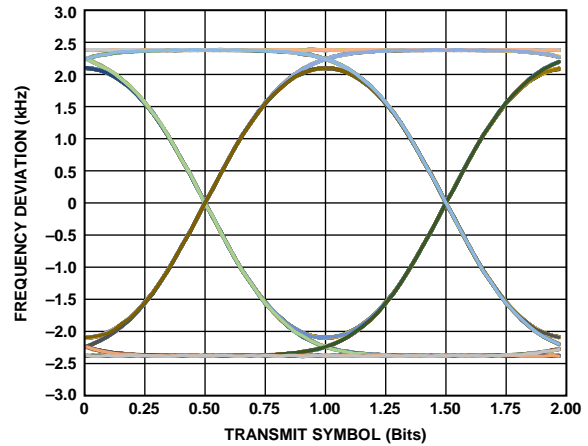

Figure 21. Transmit Eye Diagram, PA2 Output Power = 17 dBm, Configuration 169.43125 MHz/2.4 kbps,  $V_{DD} = 3.0\text{ V}$ ,  $T_A = 25^\circ\text{C}$

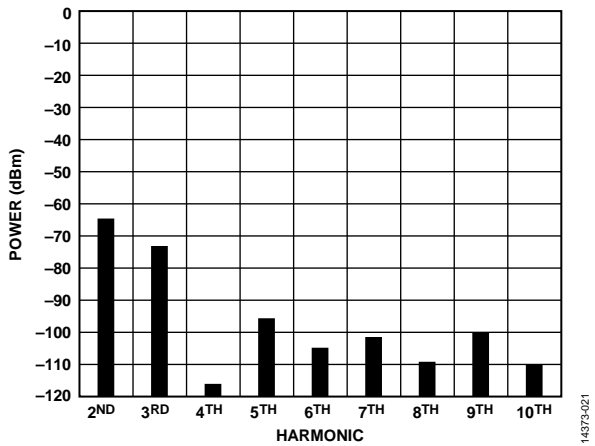

Figure 20. Conductive Harmonic Emission Level, PA2 Output Power = 17 dBm, Carrier Unmodulated, RF Frequency = 169.43125 MHz,  $V_{DD} = 3.0\text{ V}$ ,  $T_A = 25^\circ\text{C}$

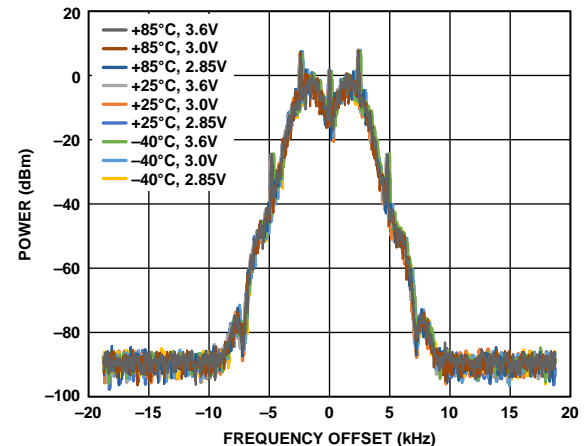

Figure 22. Transmit Spectrum, PA2 Output Power = 17 dBm, Configuration 169.43125 MHz/2.4 kbps,  $V_{DD} = 3.0\text{ V}$ ,  $T_A = 25^\circ\text{C}$

433 MHz—RECEIVE

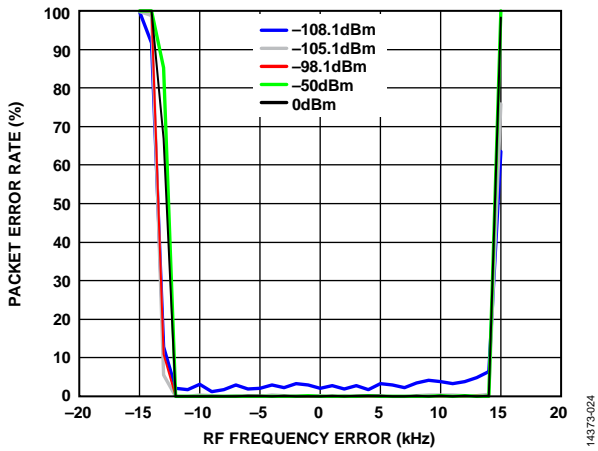

Figure 23. Packet Error Rate vs. RF Frequency Error and RF Input Power; Configuration 433 MHz/50 kbps, AFC Enabled;  $V_{DD} = 3.0\text{ V}$ ;  $T_A = 25^\circ\text{C}$

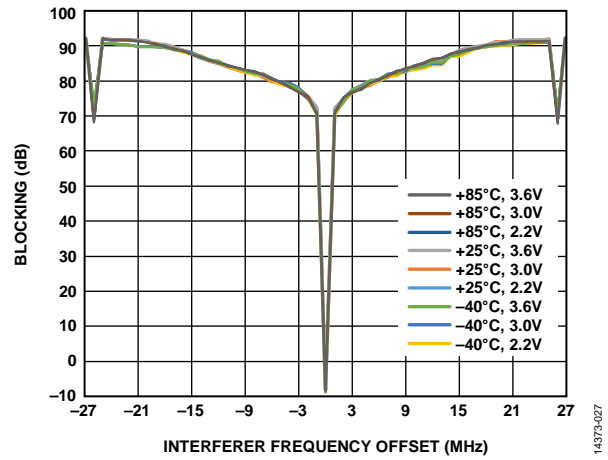

Figure 25. Receiver Wideband Blocking vs. Interferer Frequency Offset, Temperature, and  $V_{DD}$ ; Configuration 433 MHz/50 kbps; Unmodulated Interferer; Desired Signal 3 dB Above the Sensitivity Level of BER = 0.1%; BER-Based Test

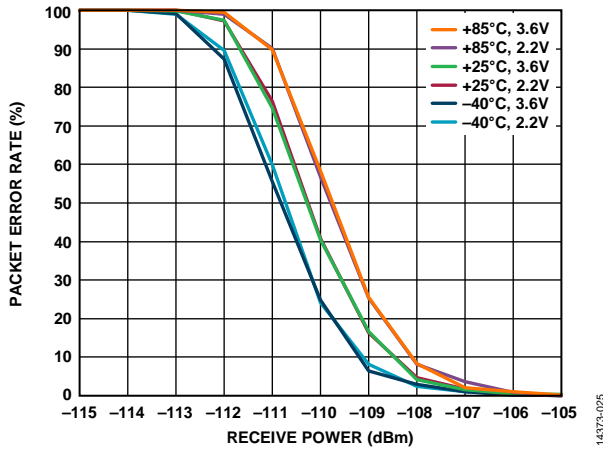

Figure 24. Packet Error Rate vs. RF Input Power, Temperature, and  $V_{DD}$ ; Configuration 433 MHz/50 kbps

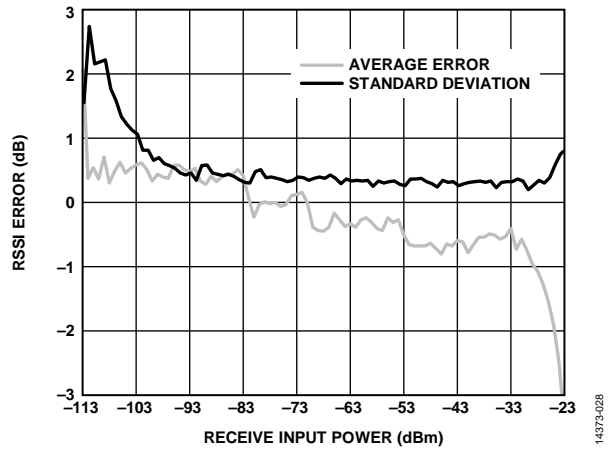

Figure 26. Packet RSSI Error vs. RX Input Power with One-Point Calibration at  $-77\text{ dBm}$ ; Configuration 433 MHz/50 kbps;  $V_{DD} = 3.0\text{ V}$ ;  $T_A = 25^\circ\text{C}$  (Error is Based on the Mean RSSI of 100 Packets)

433 MHz—TRANSMIT

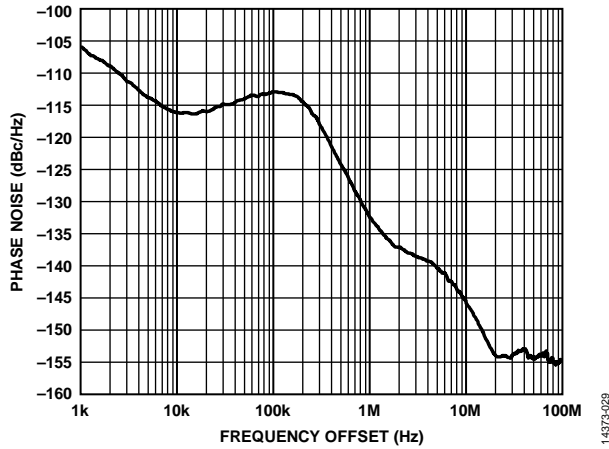

Figure 27. Phase Noise vs. Frequency Offset, RF Frequency = 433 MHz, PA1 Output Power = 10 dBm,  $V_{DD} = 3.0\text{ V}$ ,  $T_A = 25^\circ\text{C}$

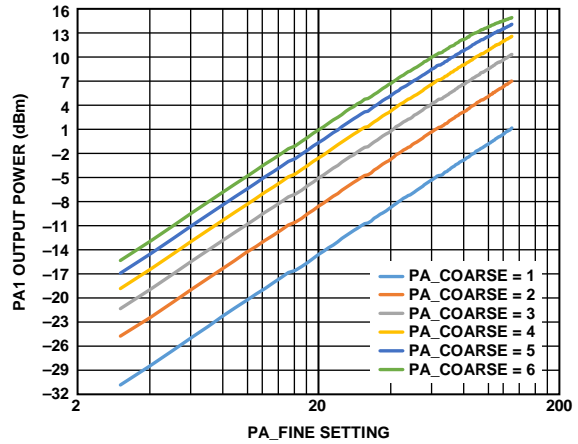

Figure 30. PA1 Output Power vs. PA\_FINE Setting and PA\_COARSE Setting with PA\_FINE on a Logarithmic Scale, RF Frequency = 433 MHz,  $V_{DD} = 3.0\text{ V}$ ,  $T_A = 25^\circ\text{C}$

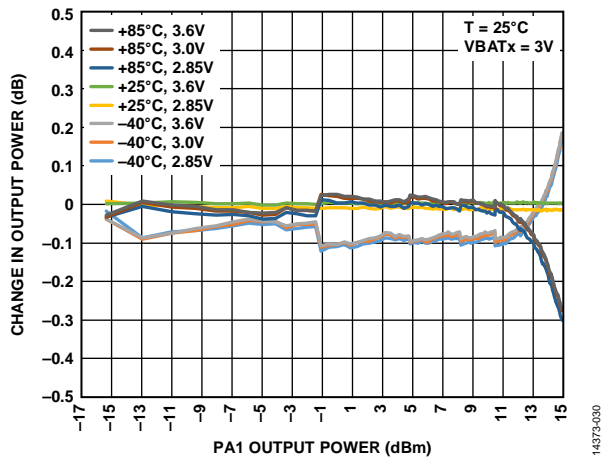

Figure 28. Change in PA1 Output Power vs. Temperature, and  $V_{DD}$  with PA\_COARSE = 6, RF Frequency = 433 MHz

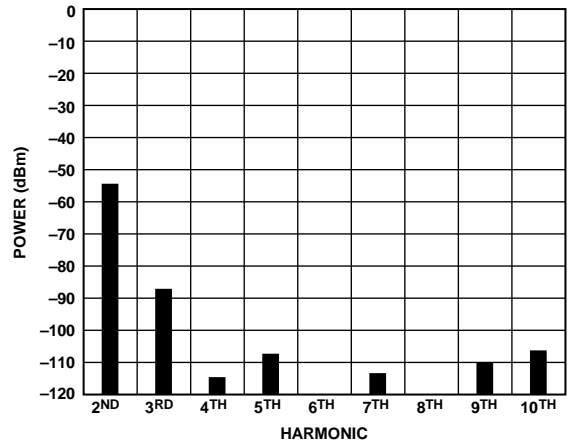

Figure 31. Conductive Harmonic Emission Level, PA1 Output Power = 10 dBm, RF Frequency = 433.92 MHz,  $V_{DD} = 3.0\text{ V}$ ,  $T_A = 25^\circ\text{C}$

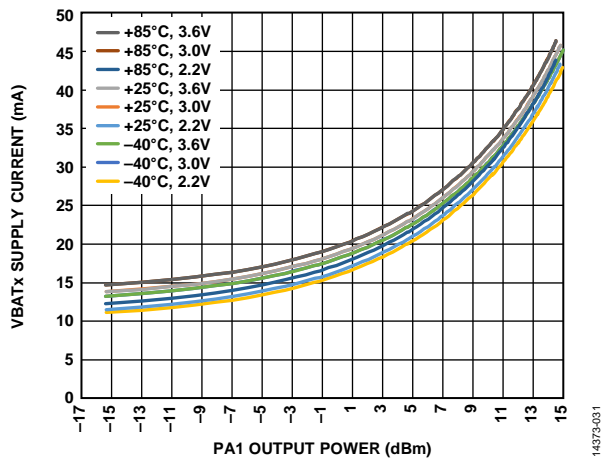

Figure 29. VBATx Supply Current vs. PA1 Output Power, Temperature, and  $V_{DD}$  with PA\_COARSE = 6, RF Frequency = 433 MHz

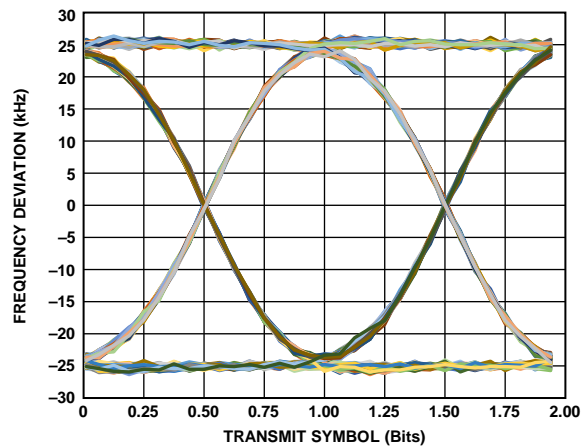

Figure 32. Transmit Eye Diagram, PA2 Output Power = 17 dBm, Configuration 433 MHz/50 kbps,  $V_{DD} = 3.0\text{ V}$ ,  $T_A = 25^\circ\text{C}$



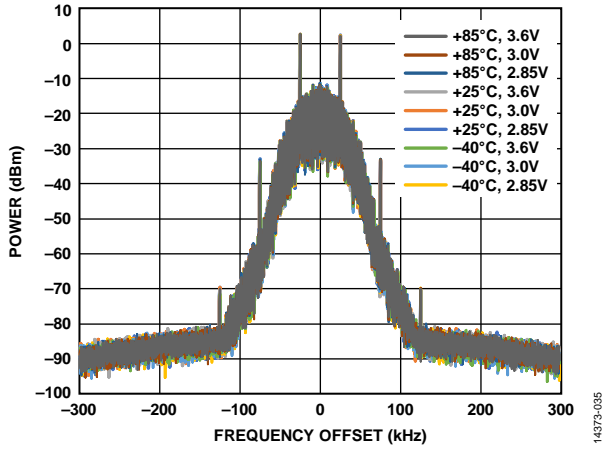

Figure 33. Transmit Spectrum, PA1 Output Power = 10 dBm, Configuration 433 MHz/50 kbps,  $V_{DD} = 3.0\text{ V}$ ,  $T_A = 25^\circ\text{C}$

460 MHz—RECEIVE

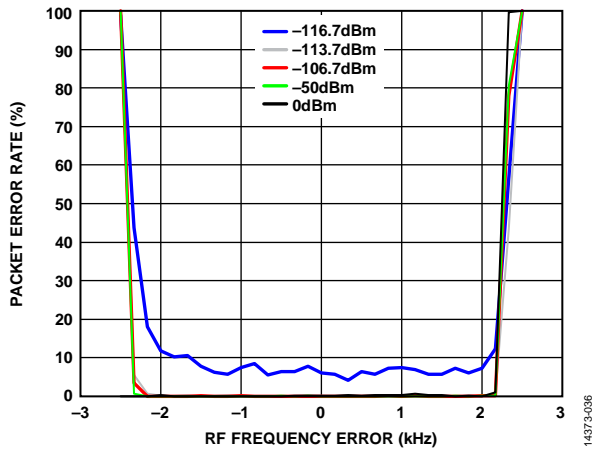

Figure 34. Packet Error Rate vs. RF Frequency Error and RF Input Power; Configuration 460 MHz/7.2 kbps; AFC Enabled;  $V_{DD} = 3.0\text{ V}$ ;  $T_A = 25^\circ\text{C}$

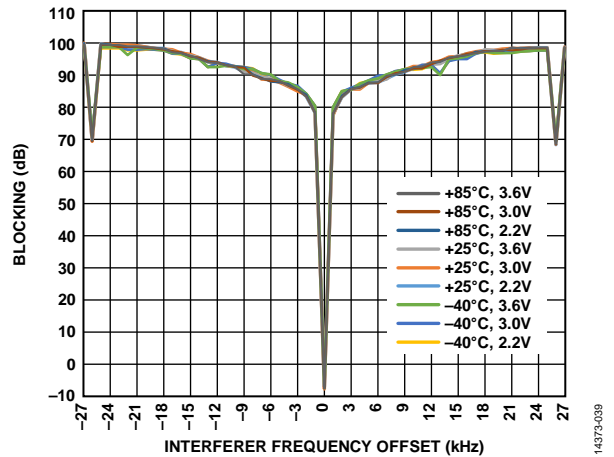

Figure 37. Receiver Wideband Blocking vs. Interferer Frequency Offset, Temperature, and  $V_{DD}$ ; Configuration 460 MHz/7.2 kbps; Unmodulated Interferer; Desired Signal 3 dB Above the Sensitivity Level of BER = 0.1%; BER-Based Test

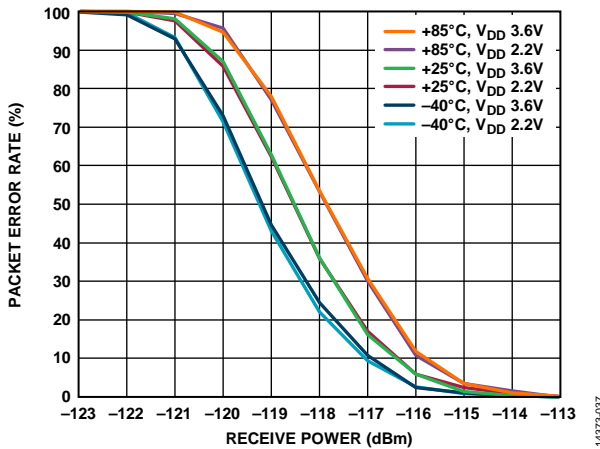

Figure 35. Packet Error Rate vs. RF Input Power, Temperature, and  $V_{DD}$ ; Configuration 460 MHz/7.2 kbps

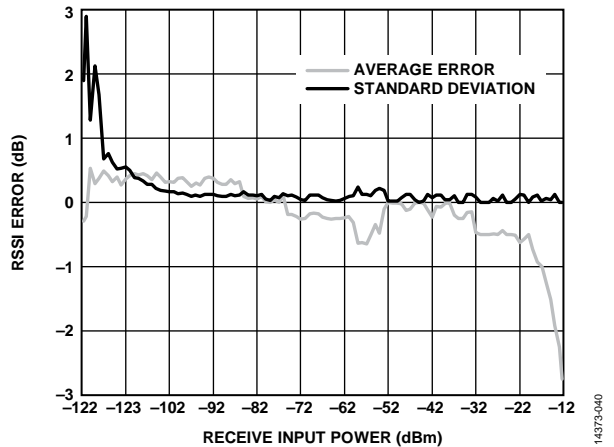

Figure 38. Packet RSSI Error vs. RF Input Power with One-Point Calibration at  $-77\text{ dBm}$ ; Configuration 460 MHz/7.2 kbps, 7.2 kbps;  $V_{DD} = 3.0\text{ V}$ ;  $T_A = 25^\circ\text{C}$  (Error is Based on the Mean RSSI of 100 Packets)

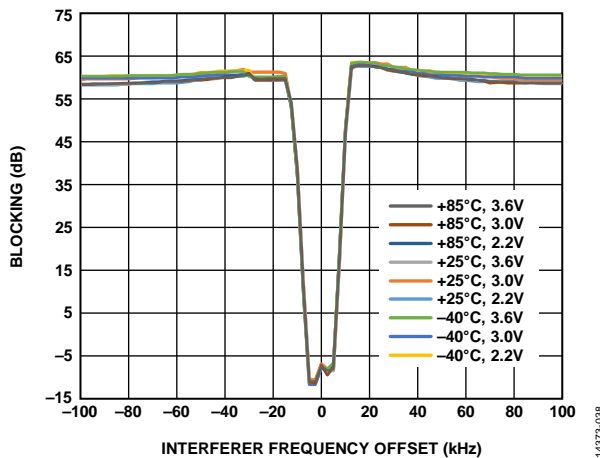

Figure 36. Receiver Close-In Blocking vs. Interferer Frequency Offset and Temperature and  $V_{DD}$ ; Configuration 460 MHz/7.2 kbps; Unmodulated Interferer; Desired Signal 3 dB Above the Sensitivity Level of BER = 0.1%; BER-Based Test

460 MHz—TRANSMIT

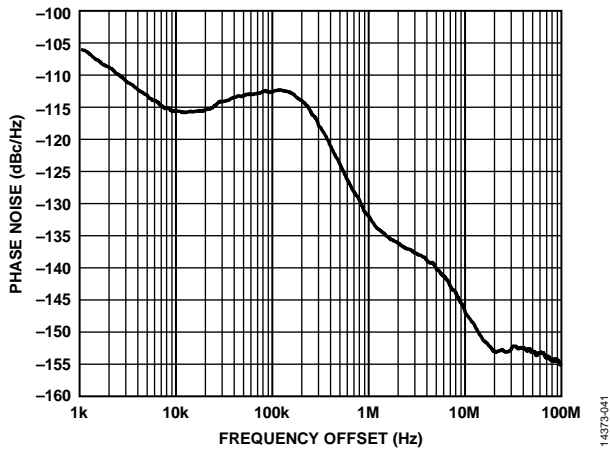

Figure 39. Phase Noise vs. Frequency Offset, RF Frequency = 460 MHz, PA2 Output Power = 17 dBm, V<sub>DD</sub> = 3.0 V, T<sub>A</sub> = 25°C

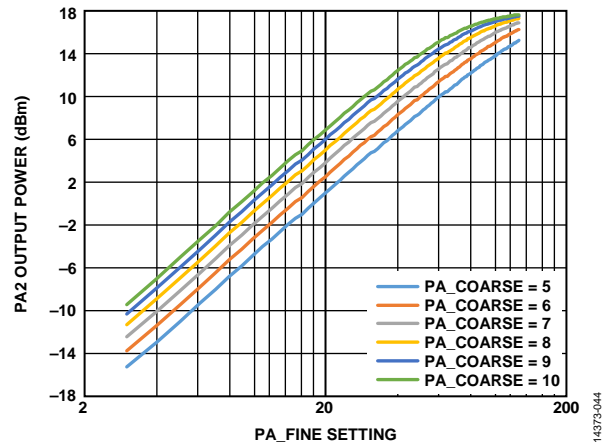

Figure 42. PA2 Output Power vs. PA\_FINE Setting and PA\_COARSE Setting with PA\_FINE on a Logarithmic Scale, PAOLDO\_VOUT\_CON=15, RF Frequency = 460 MHz, V<sub>DD</sub> = 3.0 V, T<sub>A</sub> = 25°C

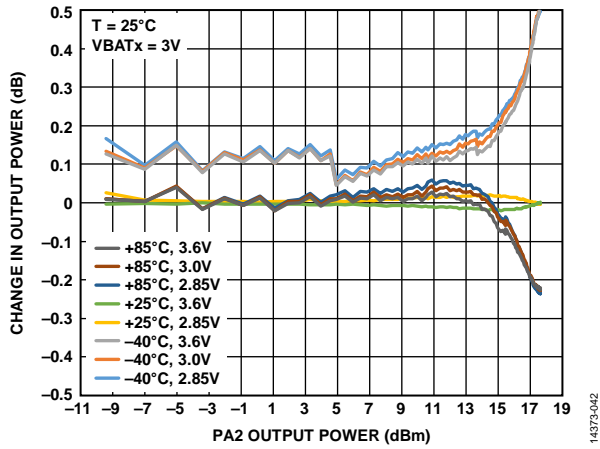

Figure 40. Change in PA2 Output Power vs. Temperature, and V<sub>DD</sub> with PA\_COARSE = 10, PAOLDO\_VOUT\_CON=15, RF Frequency = 460 MHz; Variation Above 15 dBm Can Be Improved by Matching the PA for Higher Output Power

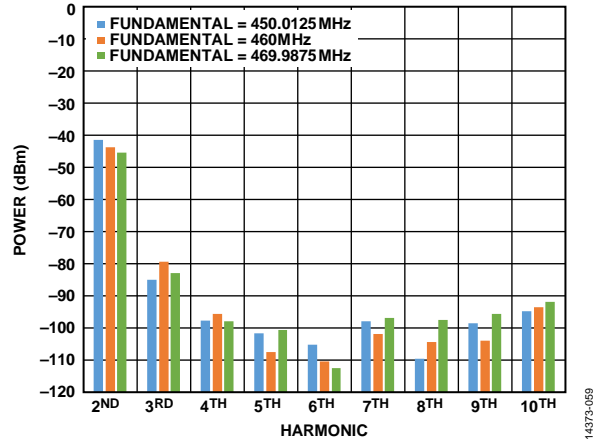

Figure 43. Conductive Harmonic Emission Level, PA2 Output Power = 17 dBm, RF Frequency = 460 MHz, V<sub>DD</sub> = 3.0 V, T<sub>A</sub> = 25°C

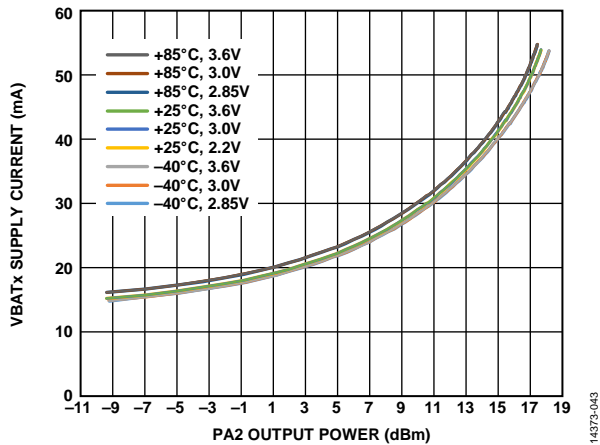

Figure 41. VBATx Supply Current vs. PA2 Output Power, Temperature, and V<sub>DD</sub> with PA\_COARSE = 10, PAOLDO\_VOUT\_CON = 15, RF Frequency = 460 MHz

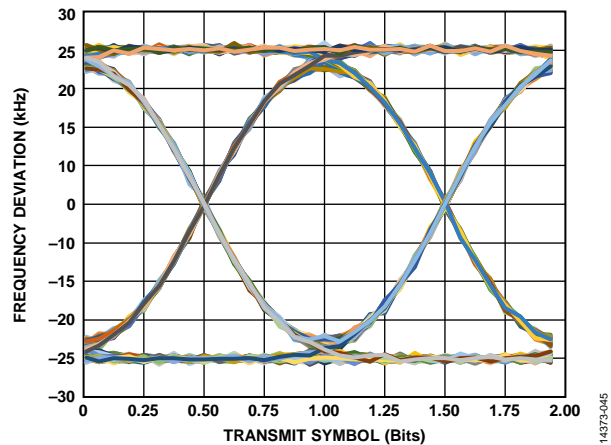

Figure 44. Transmit Eye Diagram; PA2 Output Power = 17 dBm; Configuration 460 MHz/7.2 kbps; BT = 0.5; V<sub>DD</sub> = 3.0 V; T<sub>A</sub> = 25°C

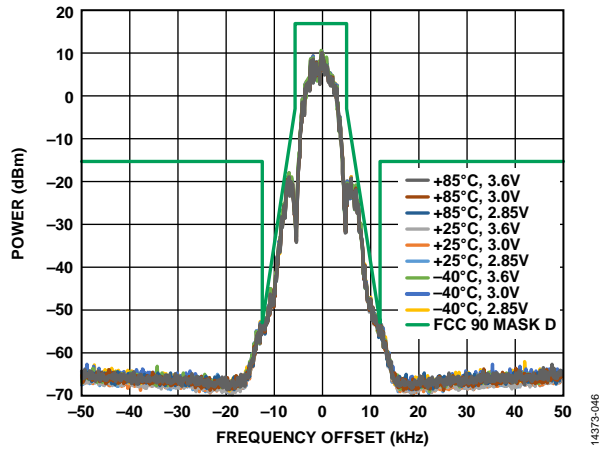

Figure 45. Transmit Spectrum, PA2 Output Power = 17 dBm, Configuration 460 MHz/7.2 kbps, BT = 0.5,  $V_{DD} = 3.0\text{ V}$ ,  $T_A = 25^\circ\text{C}$ ; Margin to the Mask Can Be Improved by Reducing the BT or By Reducing the Data Rate

868 MHz—RECEIVE

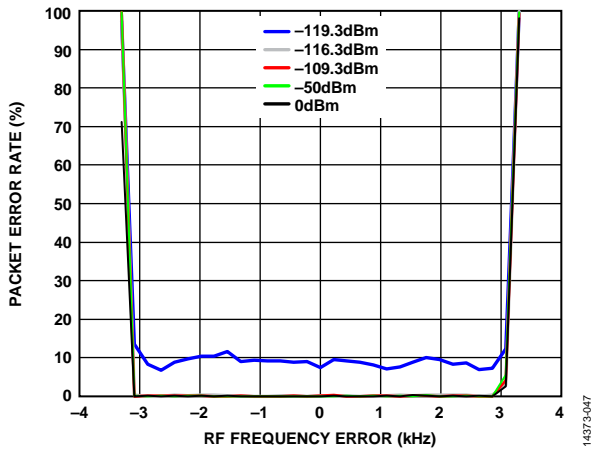

Figure 46. Packet Error Rate vs. RF Frequency Error and RF Input Power, Configuration 868 MHz/4.8 kbps, AFC Enabled,  $V_{DD} = 3.0\text{ V}$ ,  $T_A = 25^\circ\text{C}$

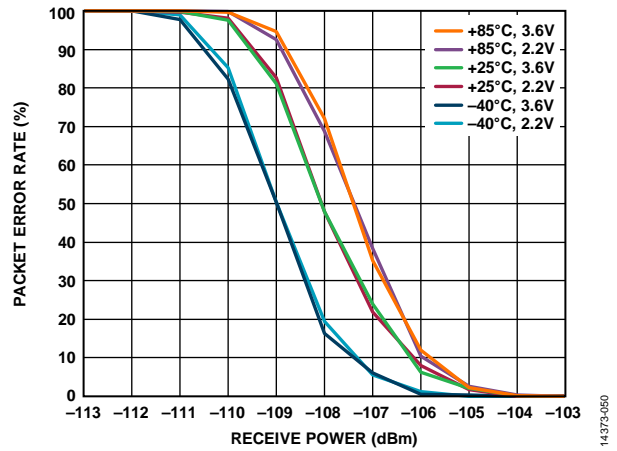

Figure 49. Packet Error Rate vs. Rx Input Power, Temperature, and  $V_{DD}$ ; Configuration 868 MHz/100 kbps

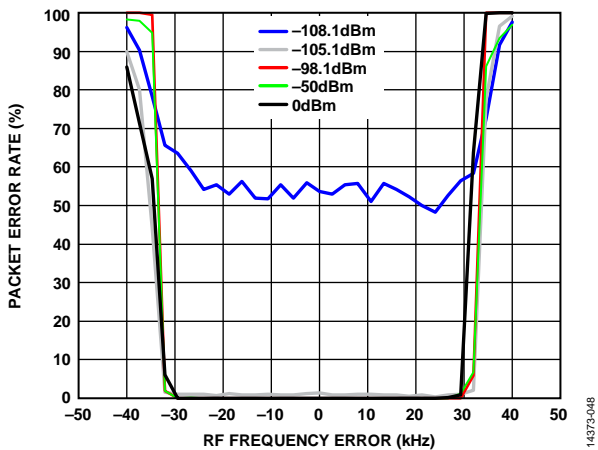

Figure 47. Packet Error Rate vs. RF Frequency Error and RF Input Power, Configuration 868 MHz/100 kbps, AFC Enabled,  $V_{DD} = 3.0\text{ V}$ ,  $T_A = 25^\circ\text{C}$

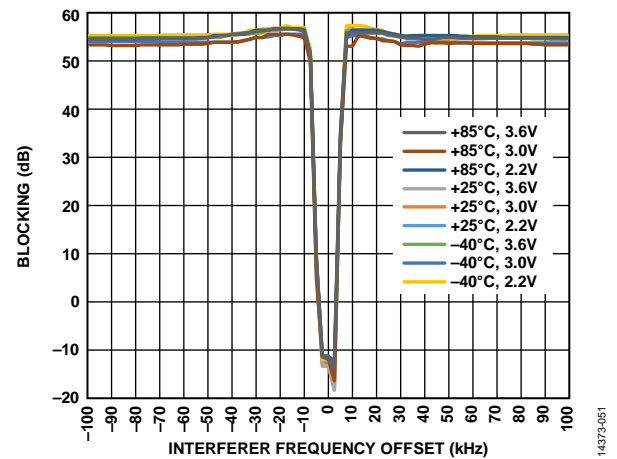

Figure 50. Receiver Close-In Blocking vs. Interferer Frequency Offset, Temperature, and  $V_{DD}$ ; Configuration 868 MHz/4.8 kbps, Unmodulated Interferer; Desired Signal 3 dB Above the Sensitivity Level of BER = 0.1%, BER-Based Test

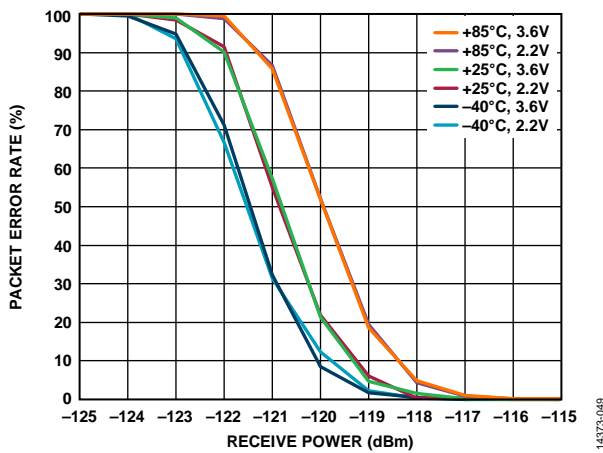

Figure 48. Packet Error Rate vs. RF Input Power, Temperature, and  $V_{DD}$ ; Configuration 868 MHz/4.8 kbps

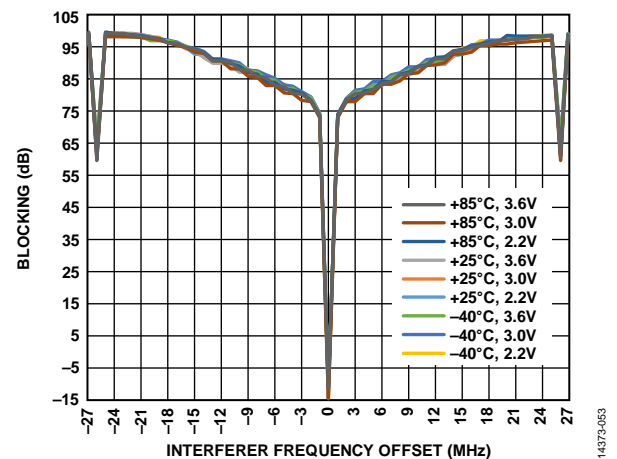

Figure 51. Receiver Wideband Blocking vs. Interferer Frequency Offset, Temperature, and  $V_{DD}$ ; Configuration 868 MHz/4.8 kbps, Unmodulated Interferer; Desired Signal 3 dB Above the Sensitivity Level of BER = 0.1%; BER-Based Test

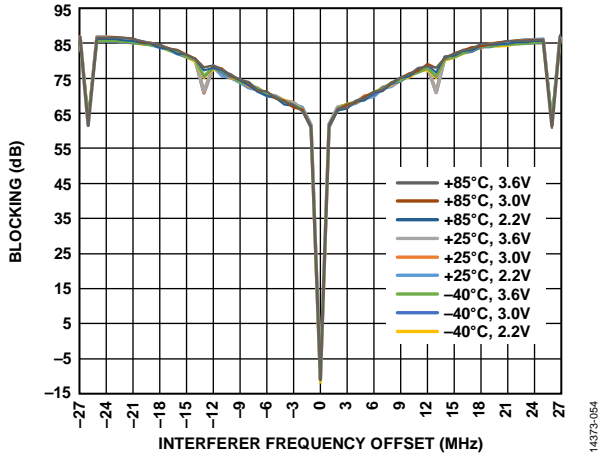

Figure 52. Receiver Wideband Blocking vs. Interferer Frequency Offset, Temperature,  $V_{DD}$ ; Configuration 868 MHz/100 kbps; Unmodulated Interferer; Desired Signal 3 dB Above the Sensitivity Level of BER = 0.1%; BER-Based Test

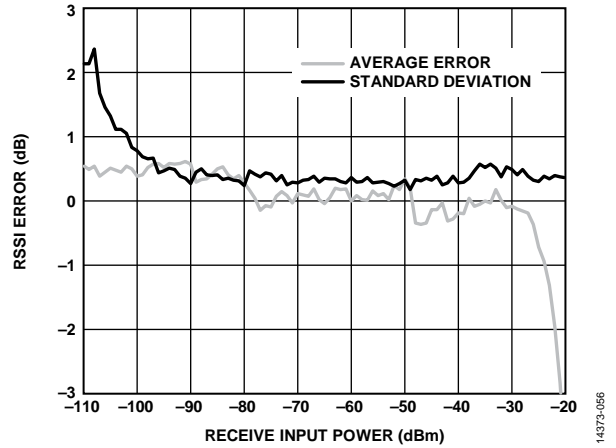

Figure 54. Packet RSSI Error vs. Rx Input Power with One-Point Calibration at -70 dBm; Configuration 868 MHz/100 kbps;  $V_{DD} = 3.0$  V;  $T_A = 25^\circ\text{C}$  (Error is Based on the Mean RSSI of 100 Packets)

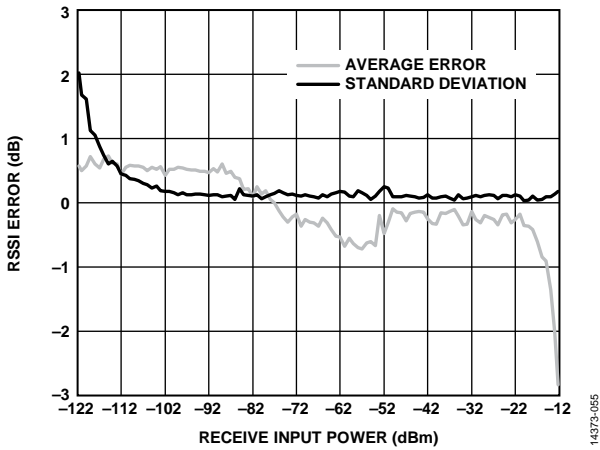

Figure 53. Packet RSSI Error vs. Rx Input Power with One-Point Calibration at -77 dBm; Configuration 868 MHz/4.8 kbps;  $V_{DD} = 3.0$  V;  $T_A = 25^\circ\text{C}$  (Error is Based on the Mean RSSI of 100 Packets)

868 MHz—TRANSMIT

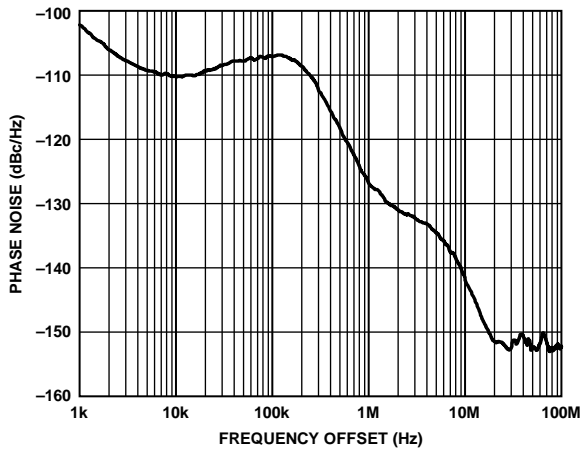

Figure 55. Phase Noise vs. Frequency Offset, RF Frequency = 868 MHz, PA2 Output Power = 17 dBm,  $V_{DD} = 3.0$  V,  $T_A = 25^\circ\text{C}$

14373-057

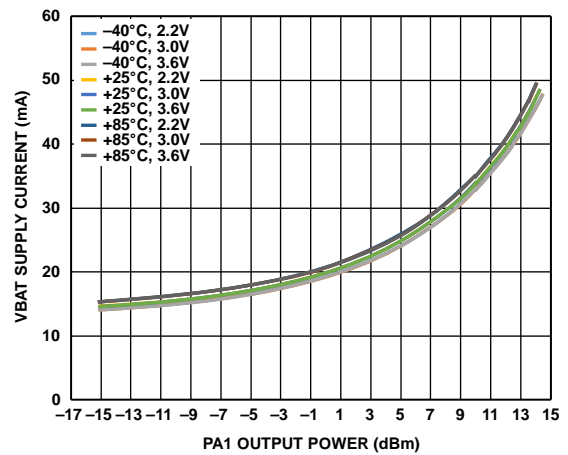

Figure 58. VBATx Supply Current vs. PA1 Output Power, Temperature, and  $V_{DD}$  with PA\_COARSE = 6, RF Frequency = 868 MHz

14373-258

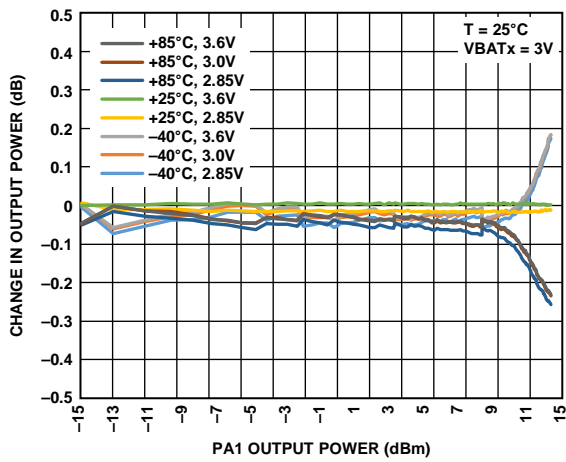

Figure 56. Change in PA1 Output Power vs. Temperature, and  $V_{DD}$  with PA\_COARSE = 10, RF Frequency = 868 MHz

14373-058

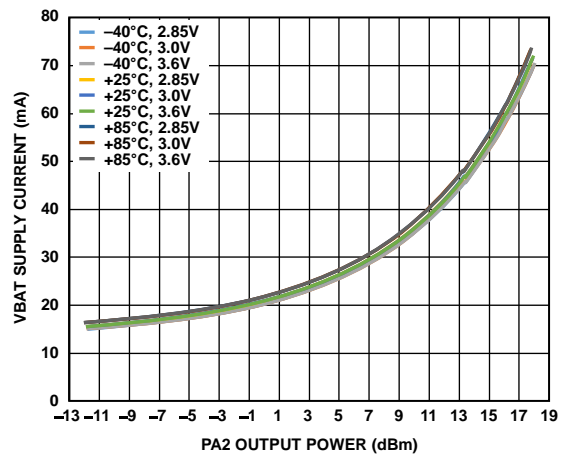

Figure 59. VBATx Supply Current vs. PA2 Output Power, Temperature, and  $V_{DD}$  with PA\_COARSE = 10, RF Frequency = 868 MHz

14373-259

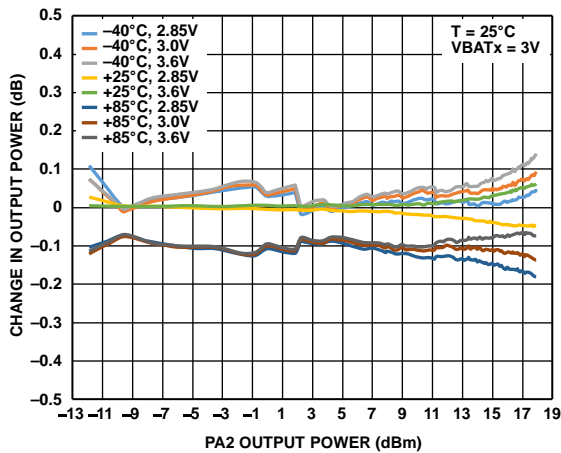

Figure 57. Change in PA2 Output Power vs. Temperature, and  $V_{DD}$  with PA\_COARSE = 10, PAOLDO\_VOUT\_CON = 15, RF Frequency = 868 MHz

14373-257

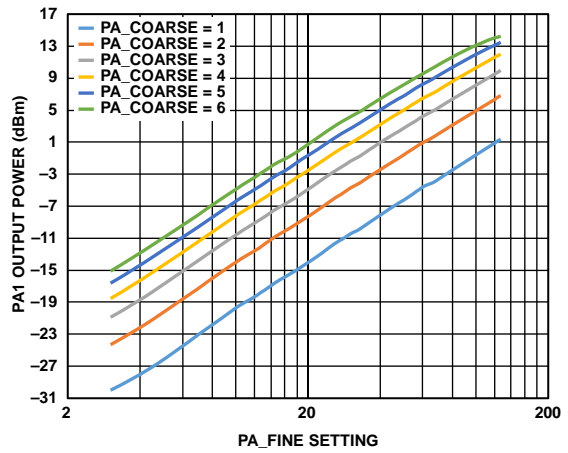

Figure 60. PA1 Output Power vs. PA\_FINE Setting and PA\_COARSE Setting with PA\_FINE on a Logarithmic Scale, RF Frequency = 868 MHz,  $V_{DD} = 3.0$  V,  $T_A = 25^\circ\text{C}$

14373-260

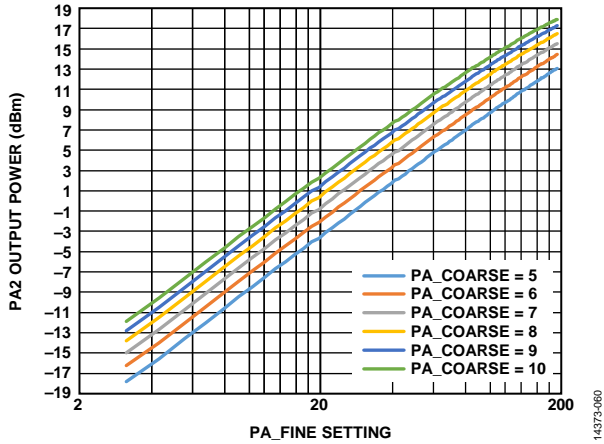

Figure 61. PA2 Output Power vs. PA\_FINE Setting and PA\_COARSE Setting with PA\_FINE on a Logarithmic Scale, PAOLDO\_VOUT\_CON = 15, RF Frequency = 868 MHz, V<sub>DD</sub> = 3.0 V, T<sub>A</sub> = 25°C

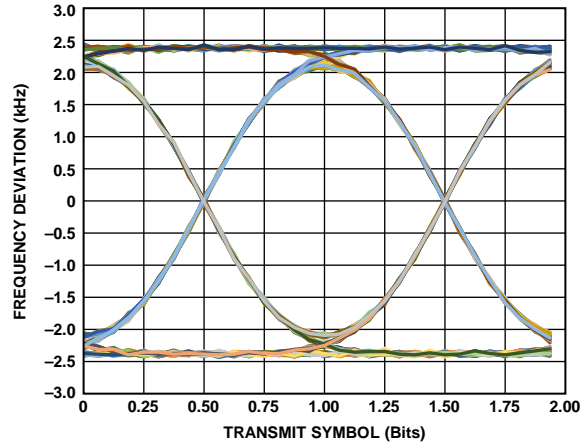

Figure 63. Transmit Eye Diagram, PA2 Output Power = 17 dBm, Configuration 868 MHz/4.8 kbps; V<sub>DD</sub> = 3.0 V; T<sub>A</sub> = 25°C

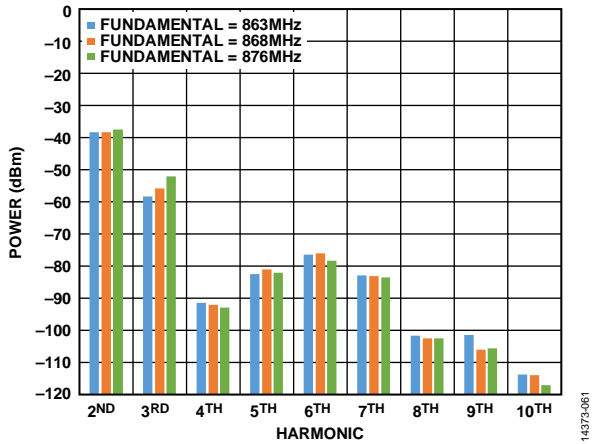

Figure 62. Conductive Harmonic Emission Level, PA2 Output Power = 17 dBm, RF Frequency = 868 MHz, V<sub>DD</sub> = 3.0 V, T<sub>A</sub> = 25°C

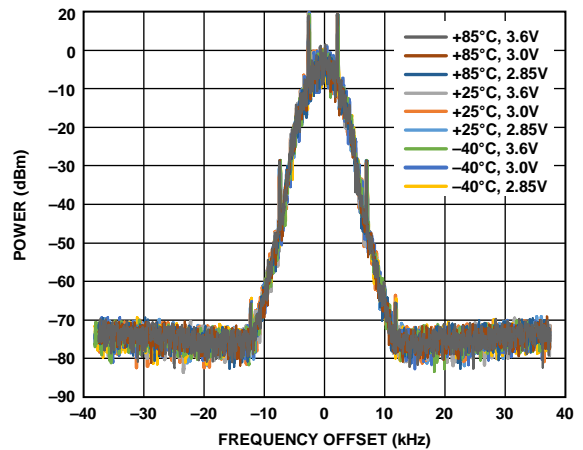

Figure 64. Transmit Spectrum vs. Temperature, and V<sub>DD</sub> with PA2 Output Power = 17 dBm, Configuration 868 MHz/4.8 kbps, V<sub>DD</sub> = 3.0 V; T<sub>A</sub> = 25°C



915 MHz—RECEIVE

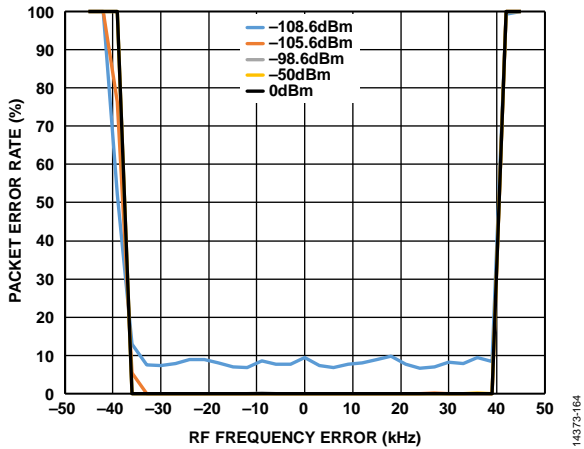

Figure 65. Packet Error Rate vs. RF Frequency Error and RF Input Power; Configuration 915 MHz/50 kbps; AFC Enabled;  $V_{DD} = 3.0\text{ V}$ ;  $T_A = 25^\circ\text{C}$

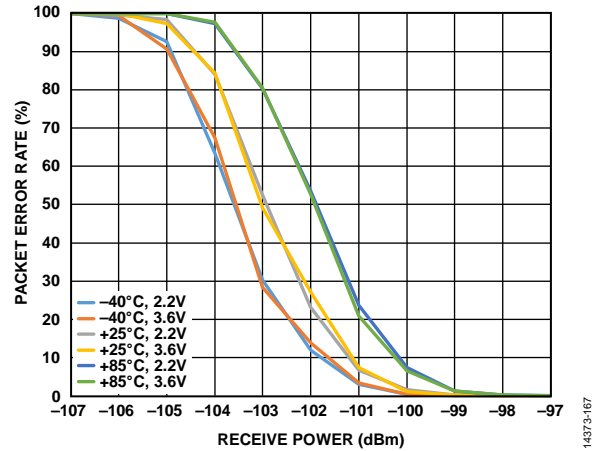

Figure 68. Packet Error Rate vs. Rx Input Power, Temperature, and  $V_{DD}$ ; Configuration 915 MHz/150 kbps; FEC Disabled; AFC Enabled

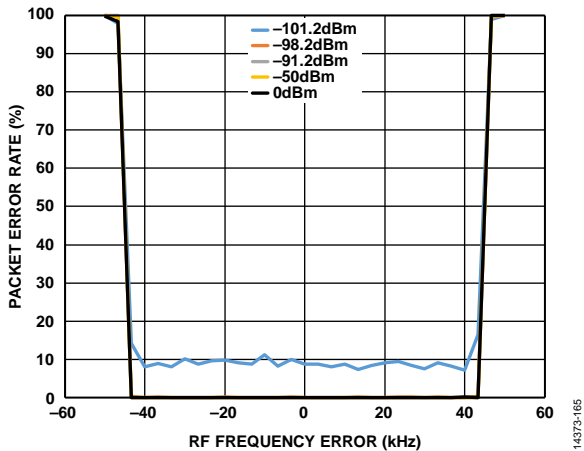

Figure 66. Packet Error Rate vs. RF Frequency Error and RF Input Power; Configuration 915 MHz/150 kbps; AFC Enabled;  $V_{DD} = 3.0\text{ V}$ ;  $T_A = 25^\circ\text{C}$

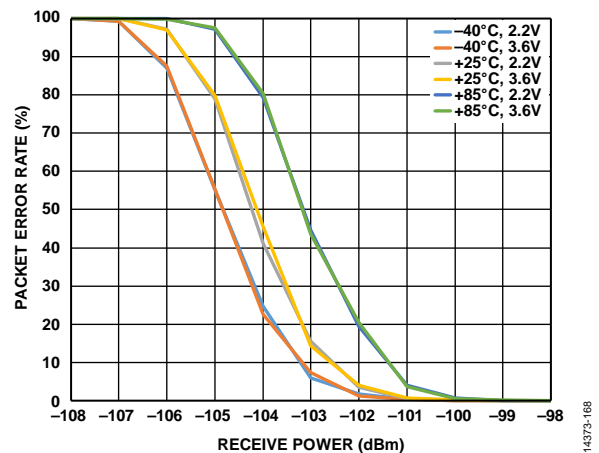

Figure 69. Packet Error Rate vs. Rx Power, Temperature, and  $V_{DD}$ ; Configuration 915 MHz/300 kbps; AFC Disabled

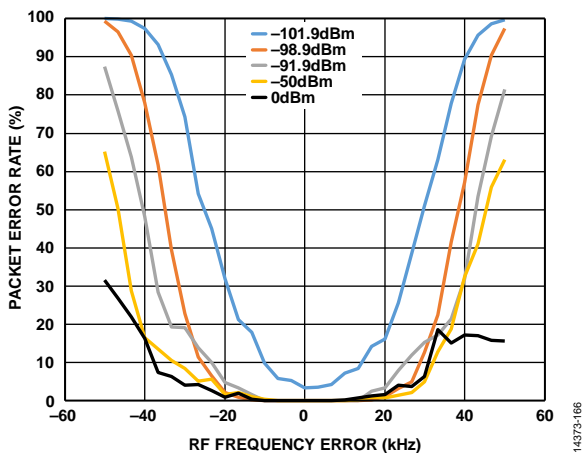

Figure 67. Packet Error Rate vs. RF Frequency Error and RF Input Power; Configuration 915 MHz/300 kbps; AFC Disabled;  $V_{DD} = 3.0\text{ V}$ ;  $T_A = 25^\circ\text{C}$

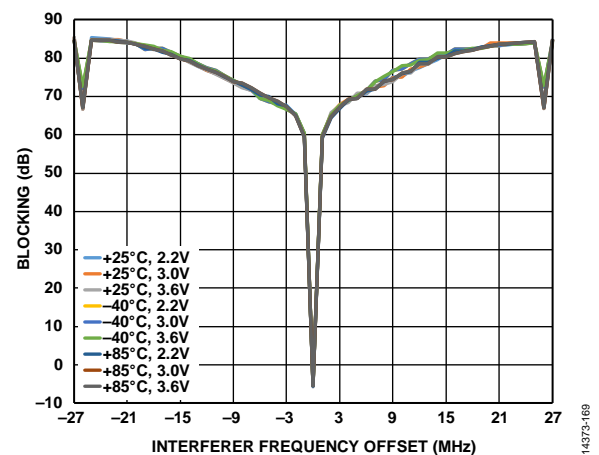

Figure 70. Receiver Wideband Blocking vs. Interferer Frequency Offset, Temperature, and  $V_{DD}$ ; Configuration 915 MHz/150 kbps; Unmodulated Interferer; Desired Signal 3 dB Above the Sensitivity Level of BER = 0.1%; BER-Based Test

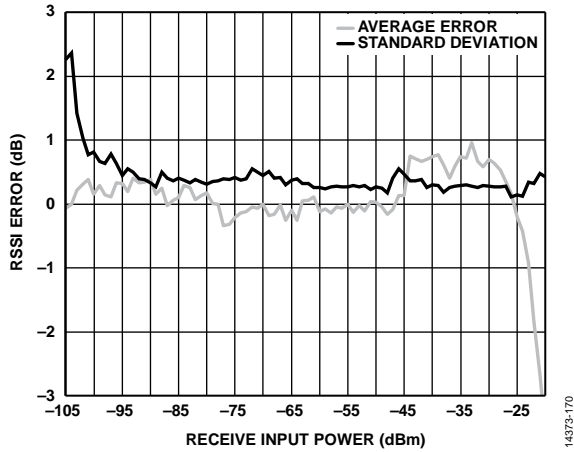

Figure 71. Packet RSSI Error vs. Rx Input Power with One-Point Calibration at  $-70$  dBm; Configuration 915 MHz/150 kbps;  $V_{DD} = 3.0$  V;  $T_A = 25^\circ\text{C}$  (Error is Based on the Mean RSSI of 100 Packets)

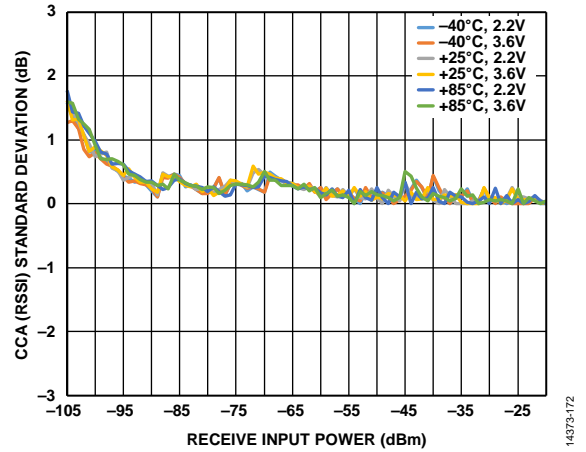

Figure 73. CCA (RSSI) Standard Deviation vs. Rx Input Power, Temperature and  $V_{DD}$ , with One-Point Calibration at  $-70$  dBm ( $V_{DD} = 2.2$  V,  $T_A = 25^\circ\text{C}$ ); Unmodulated RF Signal; Configuration 915 MHz/150 kbps (Standard Deviation is Based on 100 CCA Operations)

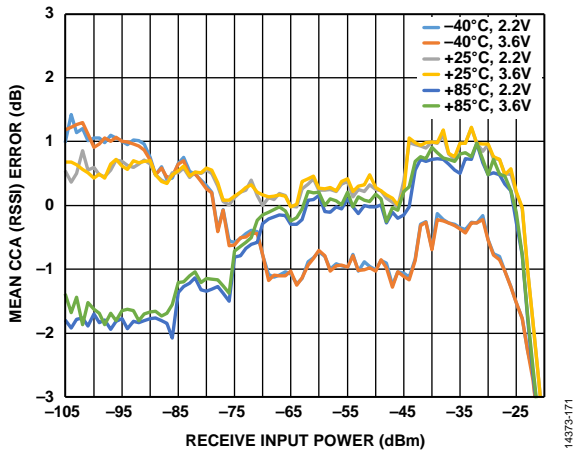

Figure 72. CCA (RSSI) Error vs. Rx Input Power, Temperature, and  $V_{DD}$  with One-Point Calibration at  $-70$  dBm ( $V_{DD} = 2.2$  V,  $T_A = 25^\circ\text{C}$ ); Unmodulated RF Signal; Configuration 915 MHz/150 kbps (Error is Based on the Mean of 100 CCA Operations)

915 MHz—TRANSMIT

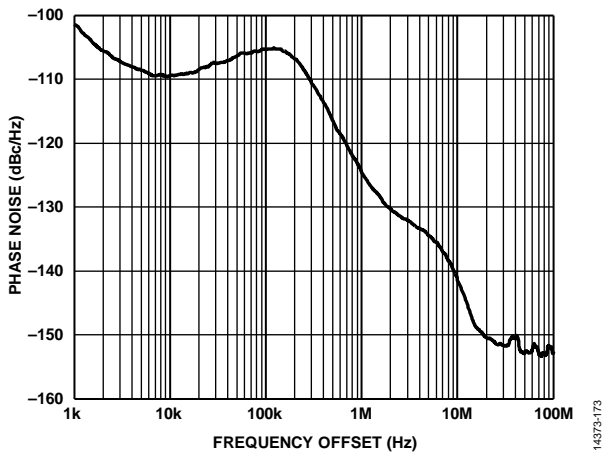

Figure 74. Phase Noise vs. Frequency Offset, RF Frequency = 915 MHz, PA2 Output Power = 17 dBm,  $V_{DD} = 3.0\text{ V}$ ,  $T_A = 25^\circ\text{C}$

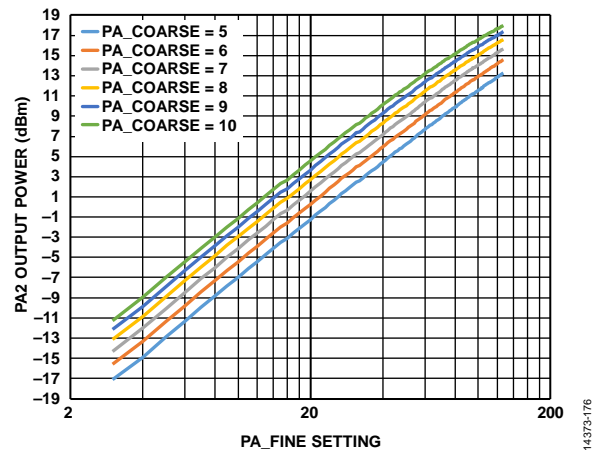

Figure 77. PA2 Output Power vs. PA\_FINE Setting and PA\_COARSE Setting with PA\_FINE on a Logarithmic Scale, PAOLDO\_VOUT\_CON = 15, RF Frequency = 915 MHz,  $V_{DD} = 3.0\text{ V}$ ,  $T_A = 25^\circ\text{C}$

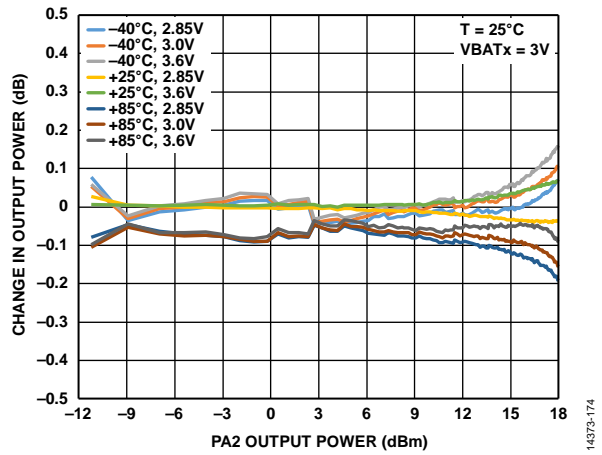

Figure 75. Change in PA2 Output Power vs. Temperature, and  $V_{DD}$  with PA\_COARSE = 10, PAOLDO\_VOUT\_CON = 15, RF Frequency = 915 MHz

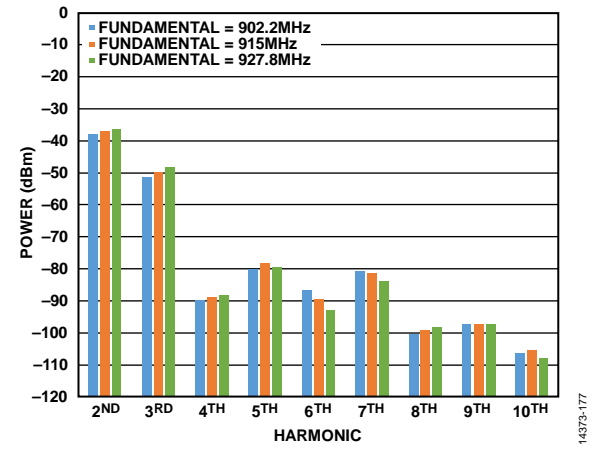

Figure 78. Conductive Harmonic Emission Level, PA2 Output Power = 17 dBm, RF Frequency = 915 MHz,  $V_{DD} = 3.0\text{ V}$ ,  $T_A = 25^\circ\text{C}$

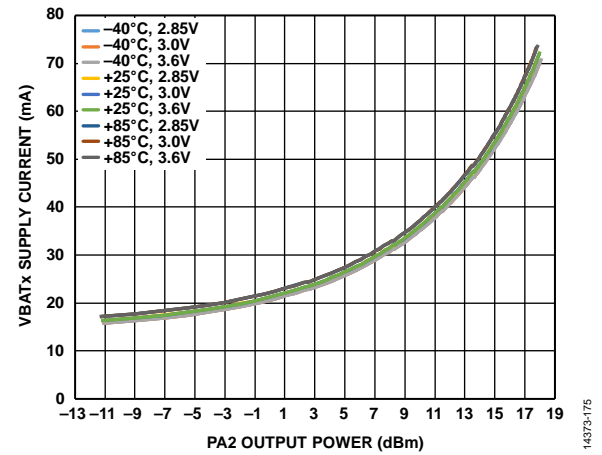

Figure 76. VBATx Supply Current vs. PA2 Output Power, Temperature, and  $V_{DD}$  with PA\_COARSE = 10, PAOLDO\_VOUT\_CON = 15, RF Frequency = 915 MHz

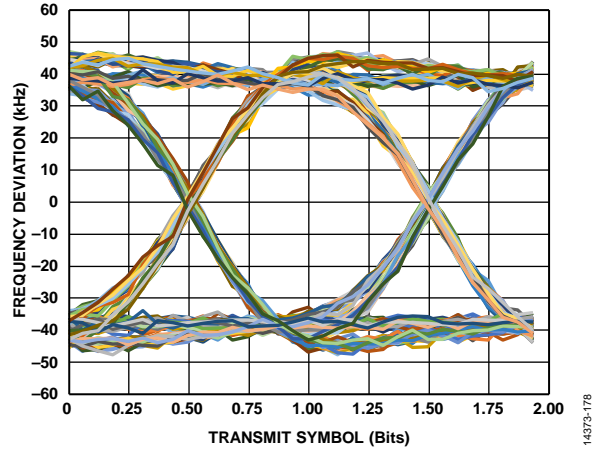

Figure 79. Transmit Eye Diagram, PA2 Output Power = 17 dBm, Configuration 915 MHz/150 kbps,  $V_{DD} = 3.0\text{ V}$ ,  $T_A = 25^\circ\text{C}$

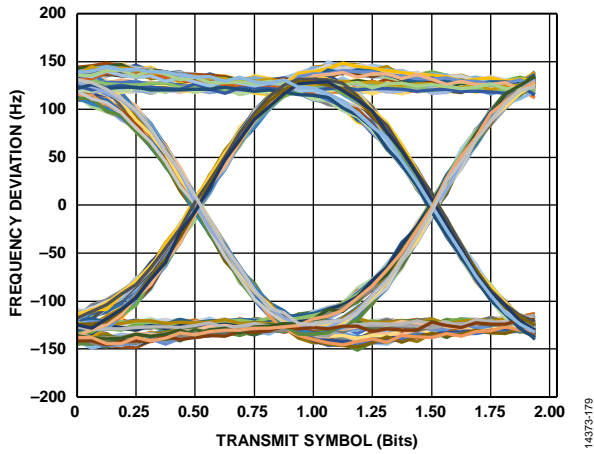

Figure 80. Transmit Eye Diagram, PA2 Output Power = 17 dBm, Configuration 915 MHz/300 kbps,  $V_{DD} = 3.0\text{ V}$ ,  $T_A = 25^\circ\text{C}$

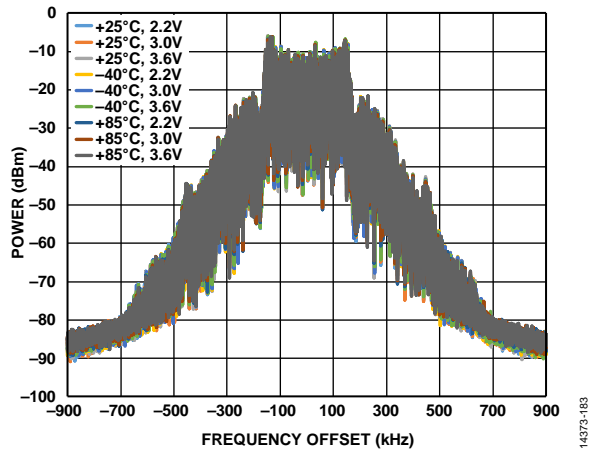

Figure 82. Transmit Spectrum vs. Temperature, and VDDPA2 Output Power = 17 dBm, Configuration 915 MHz/300 kbps;  $V_{DD} = 3.0\text{ V}$ ;  $T_A = 25^\circ\text{C}$

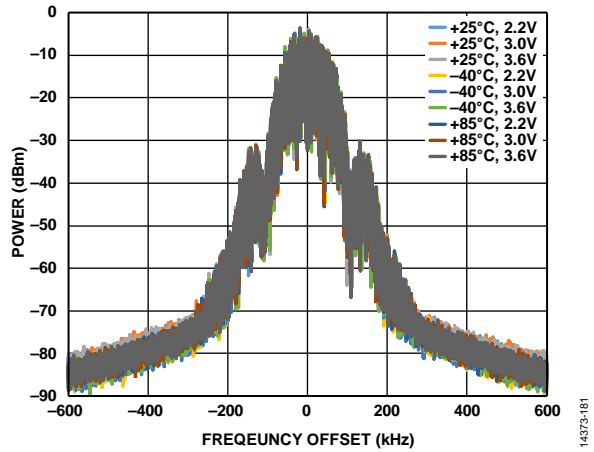

Figure 81. Transmit Spectrum, PA2 Output Power = 17 dBm, Configuration: 915 MHz/150 kbps,  $V_{DD} = 3.0\text{ V}$ ,  $T_A = 25^\circ\text{C}$

14373-179

14373-183

14373-181



## RADIO TIMING

Table 25. Radio Timing Specifications

Present State	Next State	Command/Bit	Command Initiated By	Transition Time (μs), Typical at Data Rate = 2.4 kbps	Transition Time (μs), Typical at Data Rate = 300 kbps	Condition
PHY_SLEEP	PHY_OFF	Wakeup from PHY_SLEEP (RTC timeout event)	Automatic	101	101	None
PHY_SLEEP	PHY_OFF	Wakeup from PHY_SLEEP ( $\overline{CS}$ low)	Host	101	101	From $\overline{CS}$ low to PHY_OFF
PHY_OFF	PHY_SLEEP	CMD_PHY_SLEEP	Host	95	95	From $\overline{CS}$ low to PHY_SLEEP, memory retention enabled
PHY_OFF	PHY_ON	CMD_PHY_ON	Host	206, 188	206, 188	First transition after cold start or wake from PHY_SLEEP, subsequent transitions; 26 MHz TCXO reference
PHY_OFF	PHY_ON	CMD_PHY_ON	Host	490, 188	490, 188	First transition after cold start or wake from PHY_SLEEP, subsequent transitions; 26 MHz XTAL reference
PHY_OFF	PHY_OFF	CMD_CFG_DEV	Host	36	36	RTC not enabled
PHY_ON	PHY_SLEEP	CMD_PHY_SLEEP	Host	30	30	None
PHY_ON	PHY_OFF	CMD_PHY_OFF	Host	19	19	None
PHY_ON	PHY_ON	CMD_LFRC_CAL	Host	30000	30000	None
PHY_ON	CCA	CMD_CCA	Host	230	230	To receiver enabled
PHY_ON	PHY_TX	CMD_PHY_TX	Host	245	245	To start of PA ramp
PHY_ON	PHY_RX	CMD_PHY_RX	Host	223	225	To receiver enabled
CCA	PHY_ON	CMD_PHY_ON	Host	46	46	None
CCA	PHY_ON	Channel busy	Automatic	16	16	From receiver disabled
CCA	PHY_TX	Clear channel	Automatic	208	203	From receiver disabled to start of PA ramp
CCA	PHY_TX	CMD_PHY_TX	Host	239	239	From receiver disabled to start of PA ramp
PHY_TX	PHY_ON	CMD_PHY_ON	Host	36	36	From PA ramp finished to PHY_ON
PHY_TX	PHY_ON	TX_EOF	Automatic	26	26	From PA ramp finished to PHY_ON
PHY_TX	PHY_TX	CMD_PHY_TX	Host	258	231	From start of PA ramp down (at fastest PA ramp rate) to start of PA ramp up on new channel
PHY_TX	PHY_RX	CMD_PHY_RX	Host	204	208	From PA ramp finished to receiver enabled
PHY_TX	PHY_RX	Autoturnaround	Automatic	204	208	From PA ramp finished to receiver enabled
PHY_RX	PHY_ON	CMD_PHY_ON	Host	46	46	None
PHY_RX	PHY_ON	RX_EOF	Automatic	32	32	From end of frame IRQ to PHY_ON
PHY_RX	PHY_RX	CMD_PHY_RX	Host	216	220	From $\overline{CS}$ high to receiver enabled on new channel
PHY_RX	PHY_TX	Autoturnaround	Automatic	220	220	From end of frame IRQ to start of PA ramp
PHY_RX	PHY_TX	CMD_PHY_TX	Host	203	203	From $\overline{CS}$ high to start of PA ramp

## HOST INTERFACE

### Physical Interface

The [ADF7030-1](#) provides a simple host interface (HIF) that consists of a 4-wire standard SPI, a hardware reset pin ( $\overline{\text{RST}}$ ) and GPIOs. The [ADF7030-1](#) always acts as a slave to the host processor. The host uses the SPI to read and write [ADF7030-1](#) memory and registers, to issue commands, to track the status of the state machine, and to wake up the [ADF7030-1](#) from PHY\_SLEEP.

### Host Interface Protocol

The [ADF7030-1](#) implements a very simple protocol over the SPI interface. Using this protocol, the host processor can perform a number of operations, as described in the Memory Access section, the Radio Commands section, and the Status Byte section.

### Memory Access

The memory access commands allow the host processor to read from and write to the internal memory of the [ADF7030-1](#). Typically, the host uses these commands to update the configuration of the [ADF7030-1](#) and to write packets for transmission or to read received packets.

### Radio Commands

A state machine command triggers a change of radio state as described in Table 26.

**Table 26. State Machine Radio Commands**

Command	Description
CMD_PHY_SLEEP	Performs a transition of the device into the PHY_SLEEP state
CMD_PHY_OFF	Performs a transition of the device into the PHY_OFF state
CMD_PHY_ON	Performs a transition of the device into the PHY_ON state
CMD_PHY_RX	Performs a transition of the device into the PHY_RX state
CMD_PHY_TX	Performs a transition of the device into the PHY_TX state
CMD_CFG_DEV	Configures the <a href="#">ADF7030-1</a> based on the radio profile
CMD_CCA	Performs a transition of the device into the CCA state
CMD_DO_CAL	Executes selected calibration routines; requires the OffLineCalibrations.cfg firmware module
CMD_MON	Measures and reports the <a href="#">ADF7030-1</a> temperature
CMD_LFRC_CAL	Performs a frequency calibration of the internal 26kHz RC oscillator; requires the OffLineCalibrations.cfg firmware module

### Status Byte

The [ADF7030-1](#) reports the status via a status byte. The [ADF7030-1](#) returns this byte on the SPI MISO in response to a no operation command (NOP) (0xFF) on the SPI MOSI.

### RECEIVER

The [ADF7030-1](#) features a fully integrated, highly configurable receiver that enables exceptionally high performance reception of narrow-band and wideband 2FSK/2GFSK signals. The receiver is based on a low IF architecture. Figure 84 shows a simplified block diagram of the receiver.

### RF Front End

The receive signal is amplified by a differential LNA. The LNA is followed by a quadrature downconversion mixer that converts the RF signal to the IF frequency. The automatic gain control (AGC) circuit automatically controls the gain of the RF front end. The fully integrated, fractional-N frequency synthesizer generates the LO for the mixer. When the [ADF7030-1](#) enters the PHY\_RX state, the bandwidth of the synthesizer is set automatically to ensure optimum interference rejection performance.

### IF Processing

The quadrature IF signal is band-pass filtered using a high performance, configurable analog filter. The filter is followed by a programmable gain array (PGA) that is controlled by the AGC circuit.

The [ADF7030-1](#) features a narrow-band and wideband IF processing path. In the narrow-band path, the IF signal is digitized by a high performance, high dynamic range analog-to-digital converter (ADC). RSSI, decimation, and offset correction are performed before the digitized IF is filtered using a configurable narrow-band digital channel filter.

In the wideband path, a limiter converts the IF signal to digital levels for the demodulator. The limiter also provides offset correction and RSSI, which is digitized using the ADC.

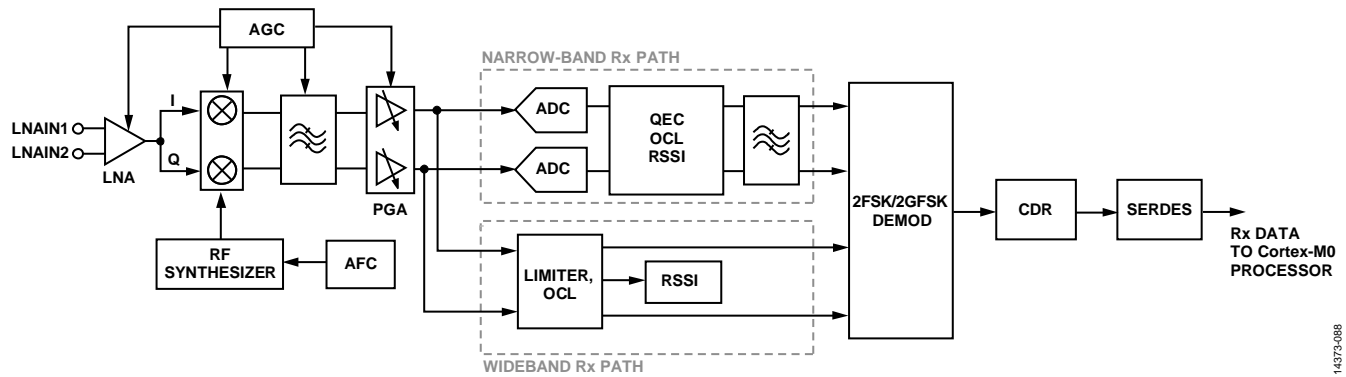

Figure 84. Receiver Block Diagram

Table 27 and Table 28 list the supported channel bandwidths and IF frequencies. The ADF7030-1 graphic user interface (GUI) automatically chooses the correct receive path, channel bandwidth, and IF frequency based on the data rate and modulation settings.

Table 27. Narrow-Band Rx Path Channel Bandwidths and IFs

Channel BW (kHz)	IF (kHz)
2.6	81.25
3.0	81.25
3.2	81.25
3.4	81.25
3.7	81.25
3.9	81.25
4.2	81.25
4.4	81.25
4.7	81.25
5.1	81.25
5.4	81.25
5.8	81.25
6.2	81.25
6.6	81.25
7.0	81.25
7.5	81.25
8.1	81.25
8.5	81.25
8.7	81.25
9.1	81.25
9.7	81.25
10.4	81.25
10.6	81.25
11.1	81.25
11.7	81.25
11.9	81.25
12.7	81.25
13.5	81.25
14.4	81.25
15.4	81.25
16.4	81.25
17.6	81.25
18.7	81.25
20.0	81.25

Table 28. Wideband Rx Path Channel Bandwidths and IFs

Channel BW (kHz)	IF (kHz)
77	155
83	110
92	184
102	135
111	222
122	162
127	154
135	271
148	196
163	325
181	240
203	406
222	295
231	241
250	336
271	360
325	432
530	540
738	588

**AGC**

AGC is enabled by default and keeps the receiver gain at the correct level by selecting the LNA, mixer, and filter gain settings based on the measured RSSI level.

**AFC**

The ADF7030-1 features an internal real-time automatic frequency control loop. In receive mode, the control loop automatically monitors the frequency error during the packet preamble sequence and adjusts the receiver synthesizer local oscillator. AFC is supported without the need for any additional preamble bits in the received packet.

**Baseband Processing**

The demodulator is based on a digital frequency correlator that performs filtering and frequency discrimination of the 2FSK/2GFSK spectrum. Following the demodulator is an oversampled digital clock and data recovery (CDR) phase-locked loop (PLL) that resynchronizes the received bit stream to a local clock in all modulation modes. A serializer/deserializer



(SERDES) block processes the received bit stream, carries out pattern matching, and produces the byte sized data for the ARM Cortex-M0 processor.

The ARM Cortex-M0 processor performs all of the byte level packet processing and packet management.

**Received Signal Strength Indicator (RSSI)**

The ADF7030-1 supports accurate measurement of the received signal strength. To achieve the calibrated absolute accuracy specification, a one-point factory calibration is required (see the Radio System Calibration section). The ADF7030-1 measures the RSSI during packet reception and the value is stored in a register for access by the host processor. The RSSI measurement is also used during CCA, where the RSSI measurement is evaluated against a user set threshold. The RSSI is reported in dBm.

**TRANSMITTER**

The ADF7030-1 transmitter supports 2FSK/2GFSK, 4FSK/4GFSK, and OOK modulation. It comprises a high performance PLL synthesizer and power efficient dual PAs. A block diagram of the ADF7030-1 transmitter architecture is shown in Figure 85. All blocks are fully integrated.

**Synthesizer and VCO**

An integrated, low noise PLL synthesizer and VCO generate both the transmit signal and the receiver LO signal.

The synthesizer loop filter has a programmable bandwidth. Upon entering the PHY\_RX state, the ADF7030-1 sets a narrow bandwidth to ensure optimum receiver rejection. In the PHY\_TX state, the bandwidth is chosen to ensure optimum modulation quality.

A high speed, fully automatic calibration scheme ensures that the VCO performance is maintained over temperature, supply voltage, and process variations. The calibration is automatically performed when the CMD\_PHY\_RX or CMD\_PHY\_TX command is issued.

**Power Amplifiers**

The ADF7030-1 has two integrated power amplifiers. PA1 and PA2 are designed for optimum power consumption performance at 13 dBm and 17 dBm, respectively. The PAs cannot be operated simultaneously. The user selects the appropriate PA for their specific system. The power amplifiers are implemented as Class F type amplifiers.

For systems where very fine power control is required, a PA microsetting can be used to achieve 0.1 dB of resolution across the power range. To reduce spectral splatter when the PA is turning on and off, a programmable PA ramp is provided.

**Transmit Modulation Schemes**

The ADF7030-1 supports 2FSK/2GFSK and 4FSK/4GFSK modulation in transmit mode. In 2FSK/2GFSK mode, a binary zero value generates a frequency deviation tone,  $-f_{DEV}$ . A binary one generates a  $+f_{DEV}$  tone. In 4FSK/4GFSK, the symbol mapping is configurable.

OOK modulation is also supported in transmit mode at a data rate of 16.384 kbps.

**Transmit Filtering**

The ADF7030-1 supports Gaussian filtering in both 2FSK and 4FSK mode. Gaussian filtering reduces the occupied bandwidth of the signal by digitally prefiltering the transmit data. The BT factors are configurable with the following options: 0.5, 0.4, 0.35, or 0.3. Reducing BT increases the roll-off factor of the filter resulting in a narrower signal bandwidth. As BT is reduced, intersymbol interference is introduced, which affects the receiver sensitivity performance.

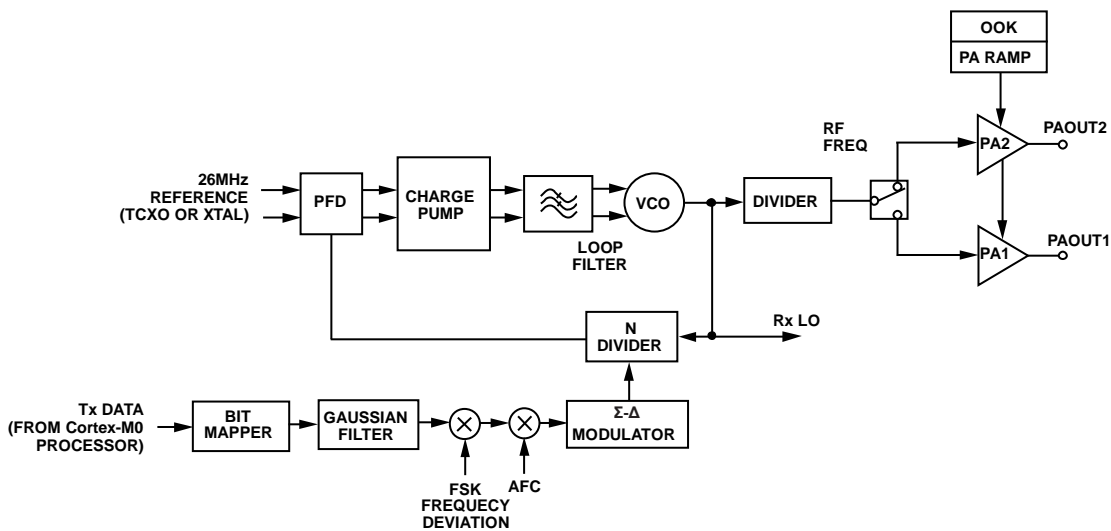

Figure 85. Transmitter Block Diagram

14373-08B

## CALIBRATION

Table 28 provides an overview of the calibrations associated with the [ADF7030-1](#) and when to run calibrations.

### Radio System Calibration

To ensure that the [ADF7030-1](#) radio performance meets the data sheet specifications, it is necessary to perform a one-time radio system calibration at  $25^{\circ}\text{C} \pm 10^{\circ}\text{C}$ .

The radio system calibration routine is provided as a firmware module, `OffLineCalibrations.cfg`, that the host processor must download to the [ADF7030-1](#) memory. The firmware module is available as part of the [ADF7030-1](#) design package. The calibration is fully autonomous when initiated by the `CMD_DO_CAL` command.

The radio system calibration firmware module can be downloaded to the [ADF7030-1](#) and run as part of a factory calibration procedure and the calibration data stored on the host processor as part of the configuration settings for the [ADF7030-1](#). Calibration data is maintained in `PHY_SLEEP` if memory retention is enabled. If the memory is not retained, the host processor must replay the calibration data to the [ADF7030-1](#). Refer to the [ADF7030-1 Software Reference Manual](#) for further details on downloading and using firmware modules with the [ADF7030-1](#).

### In the Field Radio System Calibration

The only receiver performance metric that benefits appreciably from a recalibration over temperature, is the image rejection. In applications where image rejection performance is critical over temperature, it may be necessary to perform a recalibration as the temperature changes.

If the application requires the calibration to be performed in the field (in addition to the one-time factory calibration), it is important to consider interferer signals during calibration, because the calibration uses internally generated RF signals to perform certain aspects of the receiver calibration. If an interferer signal

is present on the RF input of the [ADF7030-1](#) during calibration, this signal can degrade the calibration performance. The consequence of a degraded calibration is a reduction in the image rejection performance of the receiver.

If the application uses an external switch, the switch can be used to provide extra isolation between the antenna and the RF input of the [ADF7030-1](#) during calibration.

### 26 kHz RC Oscillator Calibration

To ensure that the 26 kHz RC oscillator meets the calibrated frequency accuracy specification, it is necessary to perform a calibration. During calibration, the `OffLineCalibrations.cfg` firmware module must be downloaded to the [ADF7030-1](#). The calibration is fully autonomous when initiated by the `CMD_LFRC_CAL` command.

Refer to the [ADF7030-1 Software Reference Manual](#) for further details.

### RSSI Offset Calibration

To ensure that the [ADF7030-1](#) RSSI performance meets the calibrated RSSI data sheet specifications, it is necessary to perform a measurement of the [ADF7030-1](#) RSSI measurement offset.

The offset can be measured as part of a factory calibration procedure where an RF signal source applies a signal to the receiver input while the [ADF7030-1](#) is in the continuous CCA state. The offset between the applied signal power and the [ADF7030-1](#) RSSI result is stored on the host processor as part of the configuration settings for the [ADF7030-1](#). The [ADF7030-1](#) has allocated registers for the RSSI offset, and the [ADF7030-1](#) automatically applies these offsets to the RSSI measurement result returned over the SPI. Refer to the [ADF7030-1 Software Reference Manual](#) for further details on the RSSI offset calibration procedure and the RSSI offset registers.

**Table 29. ADF7030-1 Calibrations**

Calibration	Description	When to Run this Calibration	Firmware Module Required	Radio Command	Typical Calibration Time (ms)
Radio System	Calibration of the radio system	A one-time calibration is required to meet the data sheet specifications. This calibration can be performed as part of a factory calibration of the end product.	The <code>OffLineCalibrations.cfg</code> firmware module must be downloaded to the <a href="#">ADF7030-1</a> .	<code>CMD_DO_CAL</code>	660
26 kHz RC Oscillator	Frequency calibration of the internal 26 kHz RC oscillator	A frequency calibration of the 26 kHz RC oscillator is required to meet the typical frequency accuracy specification. Depending on the frequency accuracy requirements of the application, it may also be necessary to calibrate as the temperature changes. Refer to Table 17 for specifications.	The <code>OffLineCalibrations.cfg</code> firmware module must be downloaded to the <a href="#">ADF7030-1</a> .	<code>CMD_LFRC_CAL</code>	30
RSSI Offset	A single point, one-time, offset calibration of the RSSI	A single-point, one-time, RSSI offset calibration is required to meet the RSSI accuracy specification of Table 3. This calibration can be performed as part of a factory calibration of the end product.	None required.	Not applicable	Not applicable

## PACKET HANDLING

The ADF7030-1 includes comprehensive transmit and receive packet management capabilities and can be configured for use with a wide variety of packet-based radio protocols.

### **IEEE 802.15.4g Packet Mode**

The ADF7030-1 supports the multirate frequency shift keying (MR-FSK) PHY 802.15.4g specified packet format in the IEEE 802.15.4g-2012 standard with FEC, whitening, and interleaving at data rates of up to 150 kbps.

### **Generic Packet Mode**

The ADF7030-1 supports a wide variety of packet formats via its fully flexible generic packet format. In generic packet transmit mode, the ADF7030-1 can be configured to add the preamble, sync word, and cyclic redundancy check (CRC) to the payload data stored in the packet memory. The number of preamble bits and sync bits is programmable, and an optional length field can be added to allow packet length decoding at the receiver. The CRC polynomial and length are fully programmable in generic packet mode.

## **Transmitting and Receiving packets**

The ADF7030-1 can be programmed to transmit and receive variable and fixed length payloads. The packet data to be transmitted must be written by the host into the ADF7030-1 internal memory. 511 bytes of dedicated RAM are available to store, transmit, and receive packets. For payload lengths greater than 511 bytes, the ADF7030-1 provides a rolling buffer mode.

To transmit or receive a packet, the host processor must first configure the ADF7030-1. Then, the host processor issues the commands to place the ADF7030-1 into the PHY\_RX state or the PHY\_TX state. After either state is entered, the ADF7030-1 automatically starts transmitting or receiving a packet.

In transmit mode, a preamble, sync word, and CRC can be added by the ADF7030-1 to the payload data stored in the RAM. In receive mode, the ADF7030-1 can qualify received packets based on preamble detection, sync word detection, or CRC validation. When the ADF7030-1 receives a valid packet, the received payload data is loaded to packet memory.

The host can track the progress of the transmission or reception of a packet by monitoring the interrupt signals coming from the ADF7030-1. There are two independent logical interrupts from the ADF7030-1, and events can be configured to trigger one or both of these logical interrupts.

# APPLICATIONS INFORMATION

## TYPICAL APPLICATION CIRCUIT

A typical application circuit is shown in Figure 86. Refer to the [ADF7030-1 Hardware Reference Manual](#) for a comprehensive

guide on application circuits, external hardware requirements, and RF matching for the [ADF7030-1](#).

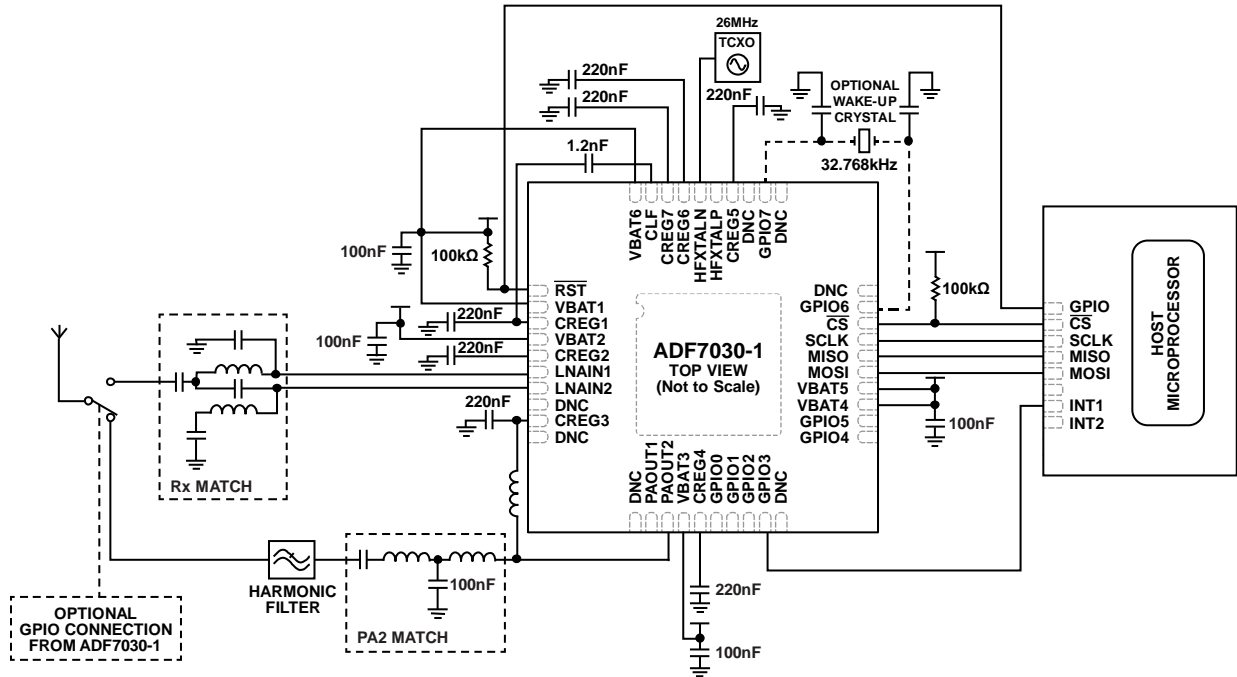

Figure 86. Typical Application Circuit with External Switch and TCXO Reference

14373-990

## SILICON ANOMALY

This anomaly list describes the known bugs, anomalies, and workarounds for the [ADF7030-1](#).

Analog Devices, Inc., is committed, through future silicon revisions and/or firmware module revisions, to continuously improve functionality. Analog Devices tries to ensure that these future revisions of the [ADF7030-1](#) silicon or firmware modules remain compatible with your present software/systems by implementing the recommended workarounds outlined here.

The silicon revision information can be electronically determined by reading the PART\_ID and ROM\_ID fields from the [ADF7030-1](#) memory locations described in Table 30.

**Table 30. Silicon Revision ID**

IF Field	Length (Bytes)	Memory Address
PART_ID	2	0x00007FF6
ROM_ID	1	0x00007FF9

## ADF7030-1 FUNCTIONALITY ISSUES

Silicon Revision ID	Chip Marking	Silicon Status	No. of Reported Anomalies
PART_ID = 0x0602, ROM_ID = 0x02	ADF7030-1BCPZN or ADF7030-1BSTZN	Release	2

## FUNCTIONALITY ISSUES

**Table 31. Short Transmit Pulse Preceding Packet preamble on OOK Transmit [er001]**

<b>Background</b>	In OOK transmit, a preamble sequence with the length controlled by PREAMBLED_LEN in the GENERIC_PKT_FRAME_CFG0 register is transmitted at the start of a packet.
<b>Issue</b>	The first OOK transmit packet after a reset event or cold start has the correct preamble sequence. Subsequent OOK transmit packets prepend a short transmit pulse with a duration of less than one bit, before the preamble sequence. The output power of the pulse is at the configured output power.
<b>Workaround</b>	None.
<b>Related Issues</b>	None.

**Table 32. CCA After Aborting PHY\_TX During Packet Transmission for Data Rates < 3.064 kbps [er002]**

<b>Background</b>	The host processor can abort a transmission by issuing any radio command while the <a href="#">ADF7030-1</a> is in the PHY_TX state.
<b>Issue</b>	For data rates < 3.064 kbps, the first CCA operation is inoperative after aborting a transmission.
<b>Workaround</b>	After aborting a transmission, enter the CCA state twice. On the first CCA entry, CCA is inoperative. On the second and subsequent entries to the CCA state, CCA is fully operational.
<b>Related Issues</b>	None.

### Section 1. ADF7030-1 Functionality Issues

Reference Number	Description	Status
er001	Short transmit pulse preceding packet preamble on OOK transmit	Open
er002	CCA after aborting PHY_TX during packet transmission for data rates < 3.064 kbps	Open

This completes the Silicon Anomaly section.

## DEVELOPMENT SUPPORT

### DESIGN PACKAGE

The [ADF7030-1](#) design resource package is a complete documentation and resource package for the [ADF7030-1](#). It is recommended to download this package as a starting point for evaluation and development from the [ADF7030-1](#) product page. It contains manuals, application notes, hardware information, and firmware modules.

### REFERENCE MANUALS

#### [ADF7030-1 Software Reference Manual \(UG-1002\)](#)

The [ADF7030-1 Software Reference Manual](#) is the detailed programming guide for the device. The [ADF7030-1](#) hardware reference manual provides a description of the [ADF7030-1](#) hardware features and application circuit requirements.

#### [ADF7030-1 Hardware Reference Manual \(UG-957\)](#)

The [ADF7030-1 Hardware Reference Manual](#) provides a description of the [ADF7030-1](#) radio functionality, hardware features, and application circuit requirements. It is intended as a resource for a hardware engineer designing a printed circuit board (PCB) that includes the [ADF7030-1](#).

### EVALUATION KITS

Evaluation and development kits are available that include the [ADF7030-1](#) radio daughter boards. The [ADF7030-1 EZ-KIT](#)<sup>®</sup> is an evaluation and development system for the [ADF7030-1](#) high performance, sub GHz, RF transceiver, and includes four models. These kits are listed in Table 33.

**Table 33. [ADF7030-1](#) EZ-KIT Models**

Model	Frequency (MHz)
<a href="#">ADF70301-915EZKIT</a>	902 to 928
<a href="#">ADF70301-868EZKIT</a>	863 to 876
<a href="#">ADF70301-433EZKIT</a>	433 to 434
<a href="#">ADF70301-169EZKIT</a>	169

A selection of individual daughter boards are also available covering various frequency bands and matching topologies.

### EVALUATION SOFTWARE

The [ADF7030-1](#) design center is a graphical user interface (GUI) that can be used for configuring the [ADF7030-1](#), evaluating transmit and receive operation, and transmitting and receiving packets. This [ADF7030-1](#) design center allows the user to rapidly prototype different configurations with the [ADF7030-1](#) and simplifies the migration to host code development.

OUTLINE DIMENSIONS

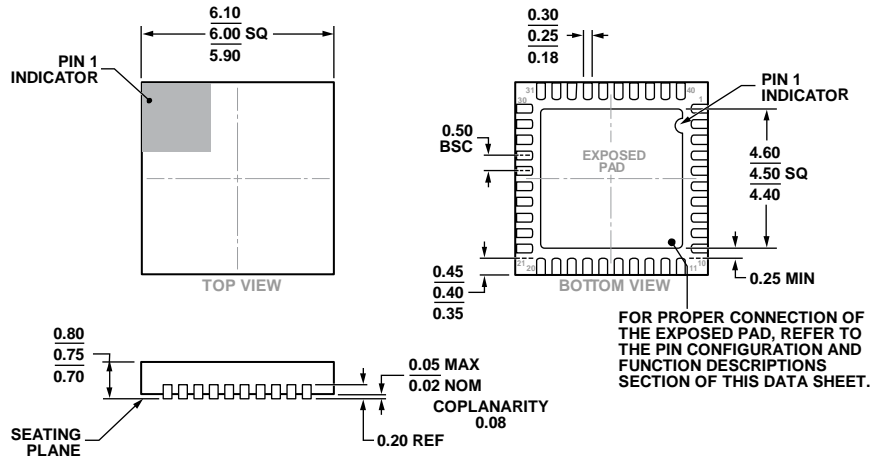

COMPLIANT TO JEDEC STANDARDS MO-220-WJJD.

Figure 87. 40-Lead Lead Frame Chip Scale Package [LFCSPP]  
6 mm x 6 mm Body and 0.75 Package Height  
(CP-40-17)

Dimensions shown in millimeters

04-10-2014-A

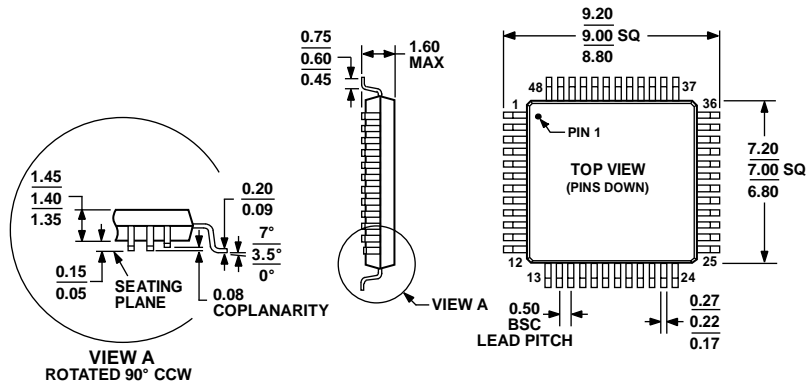

COMPLIANT TO JEDEC STANDARDS MS-026-BBC

Figure 88. 48-Lead Low Profile Quad Flat Package [LQFP]  
7 mm x 7 mm Body  
(ST-48)

Dimensions shown in millimeters

051706-A

## ORDERING GUIDE

Model <sup>1</sup>	Temperature Range	Package Description	Package Option
ADF7030-1BCPZN	-40°C to +85°C	40-Lead Lead Frame Chip Scale Package [LFCSP]	CP-40-17
ADF7030-1BCPZN-RL	-40°C to +85°C	40-Lead Lead Frame Chip Scale Package [LFCSP]	CP-40-17
ADF7030-1BSTZN	-40°C to +85°C	48-Lead Low Profile Quad Flat Package [LQFP]	ST-48
ADF7030-1BSTZN-RL	-40°C to +85°C	48-Lead Low Profile Quad Flat Package [LQFP]	ST-48
EV-ADF70301-169BZ		Evaluation Daughter Board (169 MHz, Separate PA and LNA Match, 26 MHz XTAL)	
EV-ADF70301-433AZ		Evaluation Daughter Board (433 MHz, Separate PA and LNA Match, 26 MHz XTAL)	
EV-ADF70301-460BZ		Evaluation Daughter Board (450MHz to 470MHz, Separate PA and LNA match, 26 MHz TCXO)	
EV-ADF70301-868BZ		Evaluation Daughter Board (863 MHz to 876 MHz, Separate PA and LNA match, 26 MHz TCXO)	
EV-ADF70301-915AZ		Evaluation Daughter Board (902 MHz to 928 MHz, Separate PA and LNA match, 26 MHz XTAL)	
ADF70301-169EZKIT		Evaluation and Development Kit (169 MHz)	
ADF70301-433EZKIT		Evaluation and Development Kit (433 MHz to 434 MHz)	
ADF70301-868EZKIT		Evaluation and Development Kit (863 MHz to 876 MHz)	
ADF70301-915EZKIT		Evaluation and Development Kit (902 MHz to 928 MHz)	

<sup>1</sup> Z = RoHS Compliant Part.