

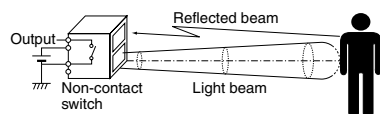

### What is area reflective type?

The sensor emits a ray of light toward the human body and detects the distance and determine whether there is a person within a given distance of the sensor. If the sensor detects a person, it sets an output non-contact switch to ON.



**Compliance with RoHS Directive**

## FEATURES

### 1. Now even more miniature.

The new thin type cuts 35% from the thickness of the previous short type. Device installing is now easier than ever.

Existing short type  
W10 × H20 × D19.5 mm  
W.394 × H.787 × D.768 inch



Thin short type  
W10 × H20 × D12.7 mm  
W.394 × H.787 × D.500 inch

\*"W" and "H" are detection value measurements.

### 2. Certain detection unaffected by the reflectance of the object

The sensor can provide stable detection that is not affected by the condition (color or material of the clothing) or parts (skin, hair, etc.) of the object being monitored. (Reflectance 18% to 90%). Excellent performance even when the detection surface is dirty.

### 3. Only connecting DC power supply for operating

Built-in oscillation circuit type obviates the hitherto existing need for start signal input.

### 4. Use in adjacent positions is possible

These sensors can be located in adjacent positions, because the timing of the external trigger signals can be adjusted so that the beam frequency of each adjacent sensor will not interfere with the other.

### 5. Battery drive possible

By applying longer interval for the trigger signal, you can reduce the total power consumption.

### 6. Can be used with a number of different supply voltages.

- 1) The 5V DC type (4.5 to 6.5V DC)
- 2) The free-ranging power type (6.5 to 27V DC)

They support the DC power supplies of electronic products and equipment in general.

\*The thin short type is only available for 5V DC.

### 7. The open collector output system makes for easy load drive.

These sensors provide a continuous output during detection because the output system makes it easy to drive the load.

They achieve an output performance of 30V, Built-in oscillation circuit type: 100 mA, External triggering type: 10 mA (Thin short type: 100 mA). Also, the thin short type is available in a PNP open collector type in addition to a NPN open collector type.

## APPLICATIONS

### 1. Water-based product market

- Automatic lighting of wash basin units
- Toilets
- Automatic water flow from faucets

### 2. Stores and financial instructions

- Automatic doors
- Automatic lighting
- Cash dispensing machines
- Automatic teller machines
- Visitor detecting sensors

### 3. Amusement market

- Automatic lighting for game display

### 4. Medical field

- Non-contact switch

### 5. Others

- Automatic ticket gates
- Seat-taking sensors
- Detection of passengers getting on and off a bus

# MA Motion Sensor (AMA1, AMB1, 2, 3)

## ORDERING INFORMATION

**AM**

MA Motion Sensor

A: Thin short type MA Motion sensor  
B: MA Motion sensor

Detection distance type (shape)  
1: Short type  
2: Middle type  
3: Long type

Triggering function  
1: External triggering type  
4: Built-in oscillation circuit type (Internal trigger)

Classification by output method & mounting direction  
0: NPN open collector/H type  
5: NPN open collector/V type  
6: PNP open collector/V type

Operating voltage  
2: Free-ranging power type (6.5 to 27V DC)  
9: The DC 5V type (4.5 to 6.5V DC)

Rated detection distance																				cm	inch
Part No.	02	03	04	05	06	07	08 (Middle type does not need 08)	09	10 (Short type does not need 10)	11	12	13	14	15	16	17	18	19	20 (Long type does not need 20)		
Thin short type	—	—	—	5 1.969	—	—	—	—	10 3.937	—	—	—	—	15 5.906	—	—	—	—	—		
Short type	—	—	—	5 1.969	6 2.362	7 2.756	8 3.150	9 3.543	10 3.937	—	—	—	—	—	—	—	—	—	—		
Middle type	20 7.874	30 11.811	40 15.748	50 19.685	60 23.622	70 27.559	80 31.496	—	—	—	—	—	—	—	—	—	—	—	—		
Long type	—	30 11.811	40 15.748	50 19.685	60 23.622	70 27.559	80 31.496	90 35.433	100 39.37	110 43.307	120 47.244	130 51.181	140 55.118	150 59.055	160 62.992	170 66.929	180 70.866	190 74.803	200 78.74		

## DETECTION DISTANCE TYPE (distance limited)

### 1. Thin short type (V type)

Mounting direction	Type (shape)	Operating voltage	Output method	Rated detection distance	Part No.		Packing quantity	
					Built-in oscillation circuit type	External triggering type	Inner	Outer
V type	Thin short type	4.5 to 6.5 V DC	NPN open collector output	5 cm 1.969 inch	AMA145905	AMA115905	20 pcs.	200 pcs.
				10 cm 3.937 inch	AMA1459	AMA1159		
				15 cm 5.906 inch	AMA145915	AMA115915		
			PNP open collector output	5 cm 1.969 inch	AMA146905	AMA116905		
				10 cm 3.937 inch	AMA1469	AMA1169		
				15 cm 5.906 inch	AMA146915	AMA116915		

Note: If you plan to use multiple sensors side-by-side, or you wish to keep the current consumption small, inquire for details about external trigger type, which is suitable for such applications.

### 2. Short type (H type)

Mounting direction	Type (shape)	Rated operating voltage	Rated detection distance	Part No.		Packing quantity	
				Built-in oscillation circuit type	External triggering type	Inner	Outer
H type	Short type	4.5 to 6.5 V DC	5 cm 1.969 inch	AMB140905	AMB110905	20 pcs.	200 pcs.
			6 cm 2.362 inch	AMB140906	AMB110906		
			7 cm 2.756 inch	AMB140907	AMB110907		
			8 cm 3.150 inch	AMB140908	AMB110908		
			9 cm 3.543 inch	AMB140909	AMB110909		
		6.5 to 27 V DC	10 cm 3.937 inch	AMB1409	AMB1109		
			5 cm 1.969 inch	AMB140205	AMB110205		
			6 cm 2.362 inch	AMB140206	AMB110206		
			7 cm 2.756 inch	AMB140207	AMB110207		
			8 cm 3.150 inch	AMB140208	AMB110208		
9 cm 3.543 inch	AMB140209	AMB110209					
10 cm 3.937 inch	AMB1402	AMB1102					

Note: If you plan to use multiple sensors side-by-side, or you wish to keep the current consumption small, inquire for details about external trigger type, which is suitable for such applications.

# MA Motion Sensor (AMA1, AMB1, 2, 3)

## 3. Middle type (H type)

Mounting direction	Type (shape)	Rated operating voltage	Rated detection distance	Part No.		Packing quantity	
				Built-in oscillation circuit type	External triggering type	Inner	Outer
H type	Middle type	4.5 to 6.5 V DC	20 cm 7.874 inch	AMB240902	AMB210902	20 pcs.	200 pcs.
			30 cm 11.811 inch	AMB240903	AMB210903		
			40 cm 15.748 inch	AMB240904	AMB210904		
			50 cm 19.685 inch	AMB240905	AMB210905		
			60 cm 23.622 inch	AMB240906	AMB210906		
			70 cm 27.559 inch	AMB240907	AMB210907		
			80 cm 31.496 inch	AMB2409	AMB2109		
		6.5 to 27 V DC	20 cm 7.874 inch	AMB240202	AMB210202		
			30 cm 11.811 inch	AMB240203	AMB210203		
			40 cm 15.748 inch	AMB240204	AMB210204		
			50 cm 19.685 inch	AMB240205	AMB210205		
			60 cm 23.622 inch	AMB240206	AMB210206		
			70 cm 27.559 inch	AMB240207	AMB210207		
			80 cm 31.496 inch	AMB2402	AMB2102		

Note: If you plan to use multiple sensors side-by-side, or you wish to keep the current consumption small, inquire for details about external trigger type, which is suitable for such applications.

## 4. Long type (H type)

Mounting direction	Type (shape)	Rated operating voltage	Rated detection distance	Part No.		Packing quantity	
				Built-in oscillation circuit type	External triggering type	Inner	Outer
H type	Long type	4.5 to 6.5 V DC	30 cm 11.811 inch	AMB340903	AMB310903	20 pcs.	200 pcs.
			40 cm 15.748 inch	AMB340904	AMB310904		
			50 cm 19.685 inch	AMB340905	AMB310905		
			60 cm 23.622 inch	AMB340906	AMB310906		
			70 cm 27.559 inch	AMB340907	AMB310907		
			80 cm 31.496 inch	AMB340908	AMB310908		
			90 cm 35.433 inch	AMB340909	AMB310909		
			100 cm 39.370 inch	AMB340910	AMB310910		
			110 cm 43.307 inch	AMB340911	AMB310911		
			120 cm 47.244 inch	AMB340912	AMB310912		
			130 cm 51.181 inch	AMB340913	AMB310913		
			140 cm 55.118 inch	AMB340914	AMB310914		
			150 cm 59.055 inch	AMB340915	AMB310915		
			160 cm 62.992 inch	AMB340916	AMB310916		
			170 cm 66.929 inch	AMB340917	AMB310917		
			180 cm 70.866 inch	AMB340918	AMB310918		
			190 cm 74.803 inch	AMB340919	AMB310919		
		200 cm 78.740 inch	AMB3409	AMB3109			
		6.5 to 27 V DC	30 cm 11.811 inch	AMB340203	AMB310203	20 pcs.	200 pcs.
			40 cm 15.748 inch	AMB340204	AMB310204		
			50 cm 19.685 inch	AMB340205	AMB310205		
			60 cm 23.622 inch	AMB340206	AMB310206		
			70 cm 27.559 inch	AMB340207	AMB310207		
			80 cm 31.496 inch	AMB340208	AMB310208		
			90 cm 35.433 inch	AMB340209	AMB310209		
			100 cm 39.370 inch	AMB340210	AMB310210		
			110 cm 43.307 inch	AMB340211	AMB310211		
			120 cm 47.244 inch	AMB340212	AMB310212		
			130 cm 51.181 inch	AMB340213	AMB310213		
			140 cm 55.118 inch	AMB340214	AMB310214		
			150 cm 59.055 inch	AMB340215	AMB310215		
			160 cm 62.992 inch	AMB340216	AMB310216		
			170 cm 66.929 inch	AMB340217	AMB310217		
			180 cm 70.866 inch	AMB340218	AMB310218		
190 cm 74.803 inch	AMB340219		AMB310219				
200 cm 78.740 inch	AMB3402	AMB3102					

Note: If you plan to use multiple sensors side-by-side, or you wish to keep the current consumption small, inquire for details about external trigger type, which is suitable for such applications.

# MA Motion Sensor (AMA1, AMB1, 2, 3)

## 5. Long type (V type)

Mounting direction	Type (shape)	Rated operating voltage	Rated detection distance	Part No.		Packing quantity	
				Built-in oscillation circuit type	External triggering type	Inner	Outer
V type	Long type	4.5 to 6.5 V DC	30 cm 11.811 inch	AMB345903	AMB315903	20 pcs.	200 pcs.
			40 cm 15.748 inch	AMB345904	AMB315904		
			50 cm 19.685 inch	AMB345905	AMB315905		
			60 cm 23.622 inch	AMB345906	AMB315906		
			70 cm 27.559 inch	AMB345907	AMB315907		
			80 cm 31.496 inch	AMB345908	AMB315908		
			90 cm 35.433 inch	AMB345909	AMB315909		
			100 cm 39.370 inch	AMB345910	AMB315910		
			110 cm 43.307 inch	AMB345911	AMB315911		
			120 cm 47.244 inch	AMB345912	AMB315912		
			130 cm 51.181 inch	AMB345913	AMB315913		
			140 cm 55.118 inch	AMB345914	AMB315914		
			150 cm 59.055 inch	AMB345915	AMB315915		
			160 cm 62.992 inch	AMB345916	AMB315916		
			170 cm 66.929 inch	AMB345917	AMB315917		
			180 cm 70.866 inch	AMB345918	AMB315918		
			190 cm 74.803 inch	AMB345919	AMB315919		
			200 cm 78.740 inch	AMB3459	AMB3159		
		6.5 to 27 V DC	30 cm 11.811 inch	AMB345203	AMB315203	20 pcs.	200 pcs.
			40 cm 15.748 inch	AMB345204	AMB315204		
			50 cm 19.685 inch	AMB345205	AMB315205		
			60 cm 23.622 inch	AMB345206	AMB315206		
			70 cm 27.559 inch	AMB345207	AMB315207		
			80 cm 31.496 inch	AMB345208	AMB315208		
			90 cm 35.433 inch	AMB345209	AMB315209		
			100 cm 39.370 inch	AMB345210	AMB315210		
			110 cm 43.307 inch	AMB345211	AMB315211		
			120 cm 47.244 inch	AMB345212	AMB315212		
			130 cm 51.181 inch	AMB345213	AMB315213		
			140 cm 55.118 inch	AMB345214	AMB315214		
			150 cm 59.055 inch	AMB345215	AMB315215		
			160 cm 62.992 inch	AMB345216	AMB315216		
			170 cm 66.929 inch	AMB345217	AMB315217		
			180 cm 70.866 inch	AMB345218	AMB315218		
190 cm 74.803 inch	AMB345219	AMB315219					
200 cm 78.740 inch	AMB3452	AMB3152					

Note: If you plan to use multiple sensors side-by-side, or you wish to keep the current consumption small, inquire for details about external trigger type, which is suitable for such applications.

## PERFORMANCE

### 1. Detection performance (Measuring conditions: ambient temp.: 25°C 77°F; operating voltage: 5 V DC)

#### 1) Thin short type

Items		Thin short type			Measured conditions
		5 cm 1.969 inch	10 cm 3.937 inch	15 cm 3.937 inch	
Rated detection distance	Minimum	45 mm	90 mm	135 mm	with a standard reflection board*1
	Typical	1.772 inch 50 mm	3.543 inch 100 mm	5.315 inch 150 mm	
	Maximum	1.969 inch 55 mm 2.165 inch	3.937 inch 110 mm 4.331 inch	5.906 inch 165 mm 6.496 inch	
Measuring tolerance	Typical	10%	25%	35%	Reflection rate: 90 to 18%
Usable ambient brightness (Resistance to ambient light)*2	Brightness of sensor surface	30,000 lx			See the drawing (Fig. 1) on the next page.
	Brightness of reflection surface	30,000 lx			

Notes: \*1. Ambient brightness: 500 lx

\*2. Install so that light from direct light sources does not enter the sensor (within 30° of the sensor light beam).

Indicates brightness detectable enough for sensor operation. (Measuring conditions: ambient temp.: 25°C 77°F; operating voltage: 5 V DC type 5V, Free-ranging power type 24V DC)

# MA Motion Sensor (AMA1, AMB1, 2, 3)

## 2) Short type

Items		Short type*1						Measured conditions
		5 cm 1.969 inch	6 cm 2.362 inch	7 cm 2.756 inch	8 cm 3.150 inch	9 cm 3.543 inch	10 cm 3.937 inch	
Rated detection distance	Minimum	45 mm 1.772 inch	54 mm 2.126 inch	63 mm 2.480 inch	72 mm 2.835 inch	81 mm 3.189 inch	90 mm 3.543 inch	with a standard reflection board
	Typical	50 mm 1.969 inch	60 mm 3.362 inch	70 mm 2.756 inch	80 mm 3.150 inch	90 mm 3.543 inch	100 mm 3.937 inch	
	Maximum	55 mm 2.165 inch	66 mm 2.598 inch	77 mm 3.031 inch	88 mm 3.465 inch	99 mm 3.898 inch	110 mm 4.331 inch	
Measuring tolerance	Typical	10%		15%	20%		25%	Reflection rate: 90 to 18%
Usable ambient brightness (Resistance to ambient light)*2	Brightness of sensor surface	Maximum 30,000 lx						See the drawing (Fig. 1) on the next page.
	Brightness of reflection surface	Maximum 30,000 lx						

Notes: \*1. After receipt of order, average rated detection distance to 15 cm 5.906 inch is possible. Please inquire.

\*2. Install so that light from direct light sources does not enter the sensor (within 30° of the sensor light beam).

## 3) Middle type (Measuring conditions: ambient temp.: 25°C 77°F; operating voltage: 5 V DC type 5V, Free-ranging power type 24V DC)

Items		Middle type*1						Measured conditions	
		20 cm 7.874 inch	30 cm 11.811 inch	40 cm 15.748 inch	50 cm 19.685 inch	60 cm 23.622 inch	70 cm 27.559 inch		80 cm 31.496 inch
Rated detection distance	Minimum	190 mm 7.480 inch	285 mm 11.220 inch	380 mm 14.961 inch	475 mm 18.701 inch	570 mm 22.441 inch	665 mm 26.181 inch	760 mm 29.921 inch	with a standard reflection board
	Typical	200 mm 7.874 inch	300 mm 11.811 inch	400 mm 15.748 inch	500 mm 19.685 inch	600 mm 23.622 inch	700 mm 27.559 inch	800 mm 31.496 inch	
	Maximum	210 mm 8.268 inch	315 mm 12.402 inch	420 mm 16.535 inch	525 mm 20.669 inch	630 mm 24.803 inch	735 mm 28.937 inch	840 mm 33.071 inch	
Measuring tolerance	Typical	3%			5%		10%		Reflection rate: 90 to 18%
Usable ambient brightness (Resistance to ambient light)*2	Brightness of sensor surface	Maximum 30,000 lx						See the drawing (Fig. 1) on the next page.	
	Brightness of reflection surface	Maximum 30,000 lx							

Notes: \*1. After receipt of order, average rated detection distance to 110 cm 43.307 inch is possible. Please inquire.

\*2. Install so that light from direct light sources does not enter the sensor (within 30° of the sensor light beam).

## 4) Long type (Measuring conditions: ambient temp.: 25°C 77°F; operating voltage: 5 V DC type 5V, Free-ranging power type 24V DC)

Items		Long type									Measured conditions
		30 cm 11.811 inch	40 cm 15.748 inch	50 cm 19.685 inch	60 cm 23.622 inch	70 cm 27.559 inch	80 cm 31.496 inch	90 cm 35.433 inch	100 cm 39.37 inch	110 cm 43.307 inch	
Rated detection distance	Minimum	285 mm 11.220 inch	380 mm 14.961 inch	475 mm 18.701 inch	570 mm 22.441 inch	665 mm 26.181 inch	760 mm 29.921 inch	855 mm 33.661 inch	950 mm 37.402 inch	1045 mm 41.142 inch	with a standard reflection board
	Typical	300 mm 11.811 inch	400 mm 15.748 inch	500 mm 19.685 inch	600 mm 23.622 inch	700 mm 27.559 inch	800 mm 31.496 inch	900 mm 34.433 inch	1000 mm 39.37 inch	1100 mm 43.307 inch	
	Maximum	315 mm 12.402 inch	420 mm 16.535 inch	525 mm 20.669 inch	630 mm 24.803 inch	735 mm 28.937 inch	840 mm 33.071 inch	945 mm 37.205 inch	1050 mm 41.339 inch	1155 mm 45.472 inch	
Measuring tolerance	Typical	3%					5%				Reflection rate: 90 to 18%
Usable ambient brightness (Resistance to ambient light)*	Brightness of sensor surface	Maximum 30,000 lx									See the drawing (Fig. 1) on the next page.
	Brightness of reflection surface	Maximum 30,000 lx									

Items		Long type									Measured conditions
		120 cm 47.244 inch	130 cm 51.181 inch	140 cm 55.118 inch	150 cm 59.055 inch	160 cm 62.992 inch	170 cm 66.929 inch	180 cm 70.866 inch	190 cm 74.803 inch	200 cm 78.74 inch	
Rated detection distance	Minimum	1140 mm 44.882 inch	1235 mm 48.622 inch	1330 mm 52.362 inch	1425 mm 56.102 inch	1520 mm 59.842 inch	1615 mm 63.583 inch	1710 mm 67.323 inch	1805 mm 71.063 inch	1900 mm 74.803 inch	with a standard reflection board
	Typical	1200 mm 47.244 inch	1300 mm 51.181 inch	1400 mm 55.118 inch	1500 mm 59.055 inch	1600 mm 62.992 inch	1700 mm 66.929 inch	1800 mm 70.866 inch	1900 mm 74.803 inch	2000 mm 78.74 inch	
	Maximum	1260 mm 49.606 inch	1365 mm 53.740 inch	1470 mm 57.874 inch	1575 mm 62.008 inch	1680 mm 66.142 inch	1785 mm 70.275 inch	1890 mm 74.409 inch	1995 mm 78.543 inch	2100 mm 82.677 inch	
Measuring tolerance	Typical	5%	10%				15%				Reflection rate: 90 to 18%
Usable ambient brightness (Resistance to ambient light)*	Brightness of sensor surface	Maximum 30,000 lx									See the drawing (Fig. 1) on the next page.
	Brightness of reflection surface	Maximum 30,000 lx									

Note: \* Install so that light from direct light sources does not enter the sensor (within 30° of the sensor light beam).

# MA Motion Sensor (AMA1, AMB1, 2, 3)

- For thin short type:  
Standard reflection board: 100 mm 3.937 inch square area,  
90% reflection rate.
- For short type:  
Standard reflection board: 100 mm 3.937 inch square area,  
90% reflection rate.
- For middle type:  
Standard reflection board: 200 mm 7.874 inch square area,  
90% reflection rate.
- For long type:  
Standard reflection board: 500 mm 19.685 inch square area,  
90% reflection rate.

Notes: 1. Detecting an object within the maximum preset detection distance.

$$2. \text{Distance deviation} = \frac{a-b}{a} \times 100 (\%)$$

a: detection distance of detection target with reflectance of 90%.

b: detection distance of standard detection target with reflectance of 18%.

<Fig. 1>

[Brightness of sensor surface]

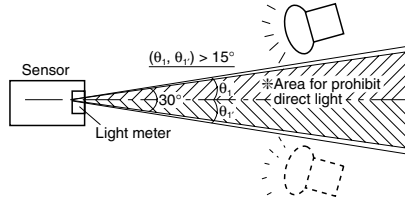

Note: Light from direct light sources (sunlight, strobe light, inverter illumination, reflected light from glass or mirrors etc.) that enters the sensor from within the prohibited range can cause the sensor to operate erroneously.

[Brightness of reflection surface]

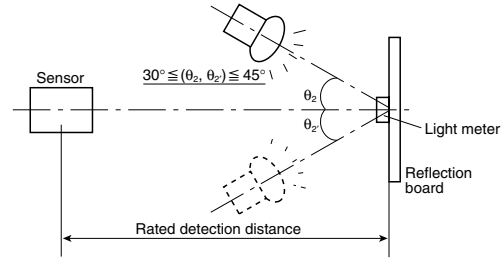

## 2. Absolute maximum rating (Measuring condition: ambient temp.: 25°C 77°F)

Items	Type	Built-in oscillation circuit type		External triggering type	
		5 V DC type	Free-ranging power type	5 V DC type	Free-ranging power type
Power supply voltage		-0.3 to 8 V DC	-0.3 to 30 V DC	-0.3 to 8 V DC	-0.3 to 30 V DC
Output dielectric strength		30 V		30 V	
Output flow current		100 mA		10 mA*	
Usable ambient temperature		-25 to +75°C +5 to +131°F (No freezing)		-25 to +75°C +5 to +131°F (No freezing)	
Storage temperature		-30 to +85°C -4 to +176°F		-30 to +85°C -4 to +176°F	

Note: \* Thin short type is only: 100 mA

## 3. Electrical characteristics

(Measuring conditions: ambient temp.: 25°C 77°F; operating voltage: 5 V DC type =5V DC, free-ranging power type =24V DC)

### 1) Built-in oscillation circuit type

Items	Symbol	Thin short type*		Short type	Middle type	Long type	Measured conditions	
		NPN output type	PNP output type					
Rated operating voltage	Minimum	5V DC type: 4.5V/Free-ranging power type: 6.5V						
	Typical	—						
	Maximum	5V DC type: 6.5V/Free-ranging power type: 27V						
Average current consumption (I <sub>out</sub> = 0 mA)	No detection	Minimum	—					
		Typical	4.5mA		5V DC type: 4.5mA/Free-ranging power type: 5.6mA			
		Maximum	6.2mA		5V DC type: 6.2mA/Free-ranging power type: 7.8mA			
	Detection	Minimum	—					
		Typical	7.0mA	11.0mA	5V DC type: 7.0mA/Free-ranging power type: 9.1mA			
		Maximum	11.2mA	15.2mA	5V DC type: 11.2mA/Free-ranging power type: 14.2mA			
Measuring cycle	Minimum	T		8ms/cycle				
Output characteristics	Remain voltage	Maximum	V <sub>r</sub>	1 V DC	1.2 V DC	1 V DC	I <sub>t</sub> = 100 mA	
	Leakage current	Maximum	I <sub>l</sub>	5μA		3μA	V = 30V	

Note: \* The thin short type is only available for 5V DC.

# MA Motion Sensor (AMA1, AMB1, 2, 3)

2) External triggering type (trigger conditions: trigger pulse width = 20μs and trigger synchronization = 5ms)

Items		Symbol	Thin short type Note 1		Short type	Middle type	Long type	Measured conditions			
			NPN output type	PNP output type							
Rated operating voltage		Minimum	5V DC type: 4.5V/Free-ranging type: 6.5V								
		Typical	—								
		Maximum	5V DC type: 6.5V/Free-ranging type: 27V								
Average current consumption		Output OFF		Minimum	—			Note 2: *b			
				Typical	0.1m	5V DC type: 0.1mA/Free-ranging type: 1.0mA					
				Maximum	0.3m	5V DC type: 0.3mA/Free-ranging type: 1.8mA					
		Output ON		Minimum	—			Note 2: *d			
				Typical	2.6mA	6.7mA	5V DC type: 0.5mA/Free-ranging type: 1.4mA				
				Maximum	6.6mA	9.6mA	5V DC type: 3.4mA/Free-ranging type: 4.5mA				
		With trigger input		Output OFF		Minimum	—			Note 2: *a	
						Typical	2.2mA	5V DC type: 2.2mA/Free-ranging type: 3.1mA			
						Maximum	6.2mA	5V DC type: 6.2mA/Free-ranging type: 7.2mA			
				Output ON		Minimum	—			Note 2: *c	
						Typical	4.2mA	6.2mA	5V DC type: 2.4mA/Free-ranging type: 3.3mA		
						Maximum	8.2mA	12.5mA	5V DC type: 8.2mA/Free-ranging type: 9.3mA		
Measuring cycle (Trigger interval)		Minimum	Tt	5ms/cycle							
External trigger		Pulse width		Minimum	20μs						
				Maximum	1/2Tt						
		Level		Maximum	V <sub>TL</sub>	0.8V			Half off the distance period		
				Minimum	V <sub>TH</sub>	3V					
Response performance: time from trigger pulse fall to detection output		Maximum	Tr	5ms			Note 3				
Output characteristics		Remain voltage	Maximum	Vr	1 V DC	1.2 V DC	1 V	I = 10 mA			
		Leakage current	Maximum	II	5μA		3μA	V = 30 mA			

Notes: 1. The thin short type is only available for 5V DC.

2. The ratio between the 4 operating modes (\*a to \*d) depends on the external trigger period and detector time, and the current consumption corresponds with this varying ratio.

4. The output transistor is open collector.

The output transistor is turned ON by the sensor detection status and turned OFF by its non-detection status.

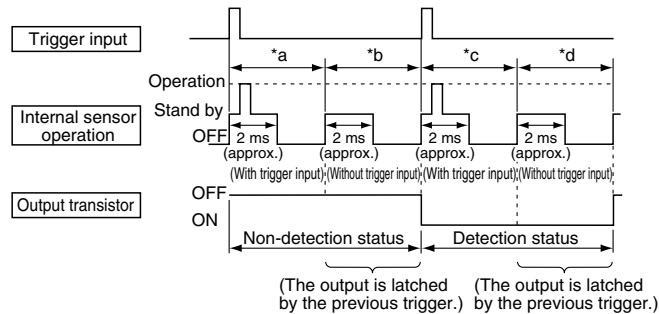

3. A high level is established in the open state due to pull-up by the internal circuit. (Refer to the connector wiring diagram.)

Detection status: output transistor ON  
Non-detection status: output transistor OFF

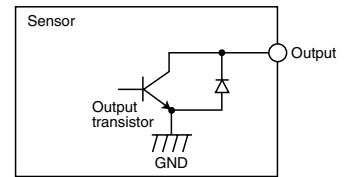

(NPN output types of the AMA series and all of AMB series)

Detection status: output transistor ON  
Non-detection status: output transistor OFF

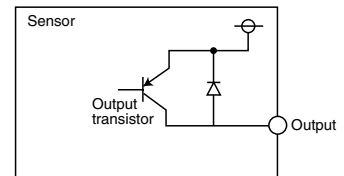

(PNP output types of the AMA series)

## TIMING CHART

### 1. Built-in oscillation circuit type

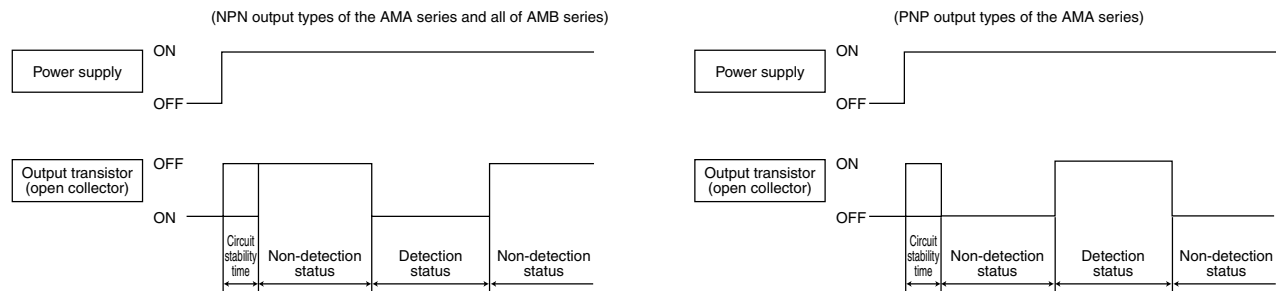

Notes: 1. Circuit stability time : Max. 12 ms

2. During the time taken for the circuit to stabilize after the power is turned on, the ON/OFF status of the output transistor is not determined by whether the sensor is in the detection status or non-detection status.



# MA Motion Sensor (AMA1, AMB1, 2, 3)

## 2. External triggering type

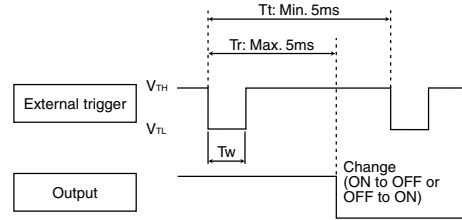
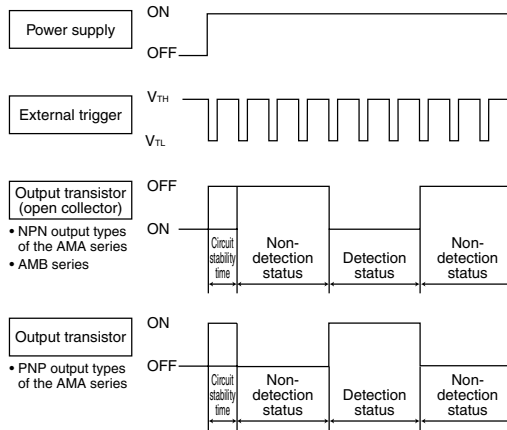

Notes: 1. Circuit stability time : Max. 12 ms

2. During the time taken for the circuit to stabilize after the power is turned on, the ON/OFF status of the output transistor is not determined by whether the sensor is in the detection status or non-detection status.

Note: The sensor recognizes at the  $V_{TH} \rightarrow V_{TL}$  edge of an external trigger that the external trigger has been input.

## HOW TO USE

### • Wiring diagram of connector

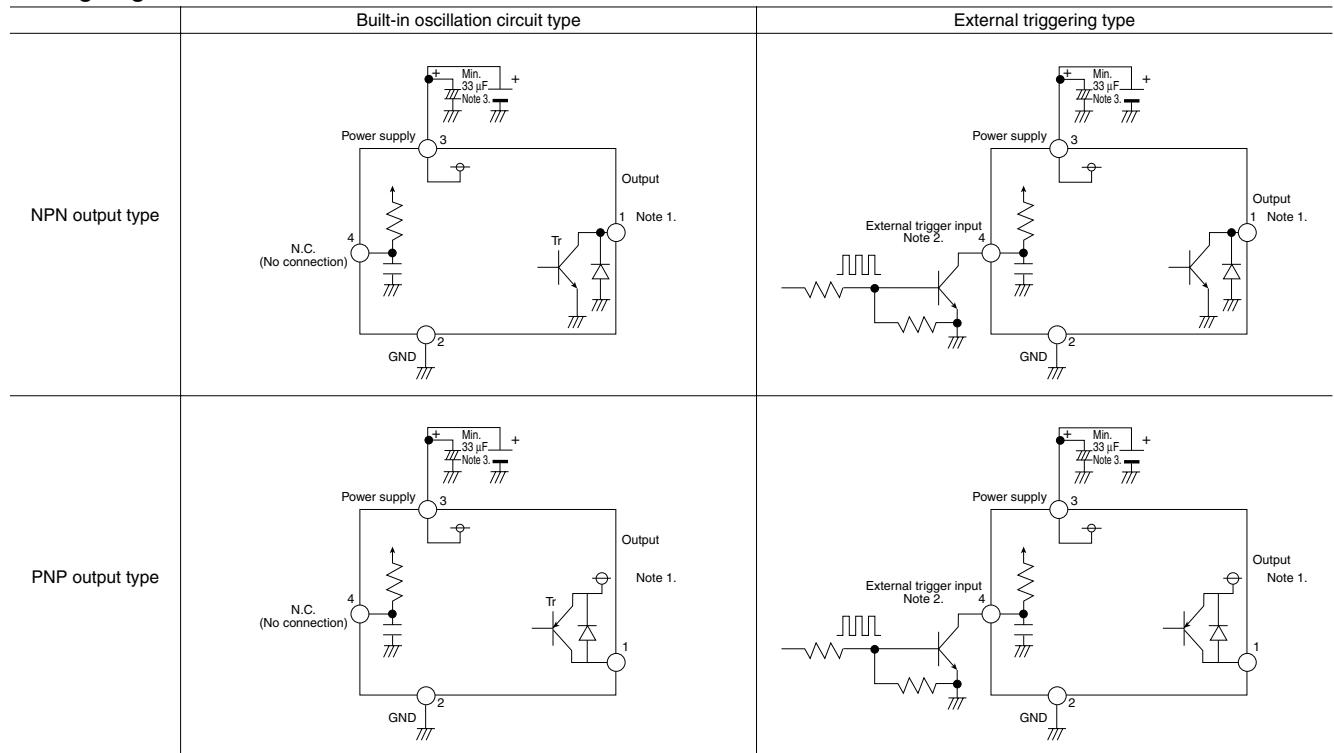

Notes: 1. The output transistor has an open collector structure.

- Detection status: Output transistor ON (connected to GND)
- Non-detection status: Output transistor OFF (open state)

2. The status of the external trigger input is as follows:

- Open at the high level
  - GND (less than 0.8V) at the low level
- Under no circumstances must a high-level voltage be applied.

3. To maintain the power supply noise performance, be certain to connect a capacitor (33µF or more) to the sensor power supply input terminal in order to stabilize the power supply voltage.



# MA Motion Sensor (AMA1, AMB1, 2, 3)

## REFERENCE DATA

### Operating region characteristics

- How to interpret the graph

Example: Operating area of the Short Type with rated detection distance of 8 cm 3.150 inch.

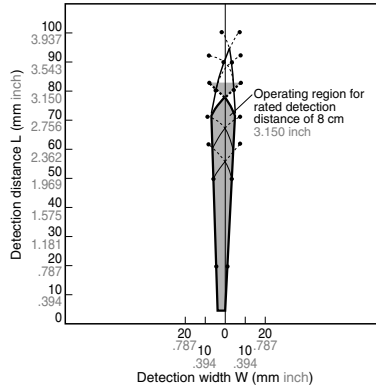

Operating area within the dotted lines

Objects that enter the entire area are detected.

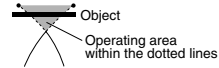

Note: If only part of the object is in the detection area, it is not detected.

Operating area within the solid lines

Objects that even partially enter the area are detected.

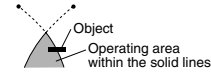

### (1) Thin short type (AMA14□□□□□) Short type (AMB14□□□□□)

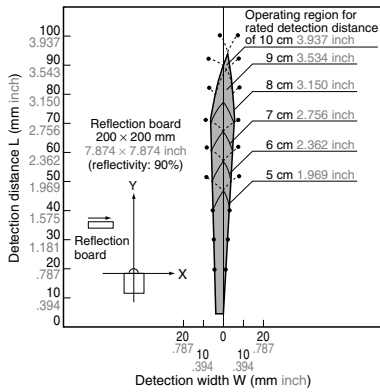

### (2) Middle type (AMB24□□□□□)

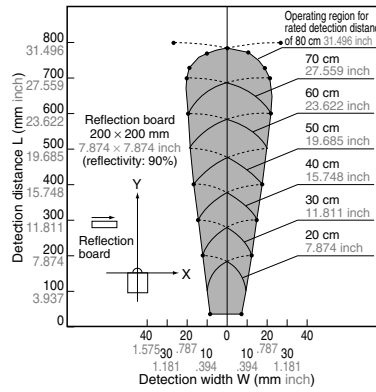

### (3) Long type (AMB34□□□□□)

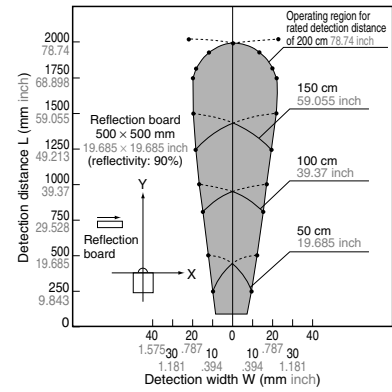

## DIMENSIONS (Common to the Built-in oscillation circuit type and External triggering type)

mm inch

### 1) Thin short type (V)

### 2) Short type (H)

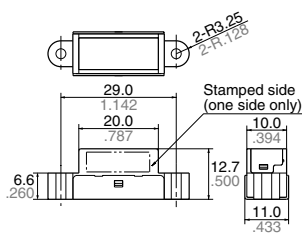

\*Rear side connector protrusion: Max. 0.4mm

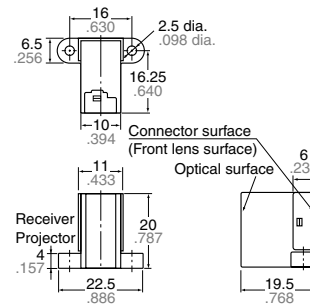

### 3) Middle type (H)

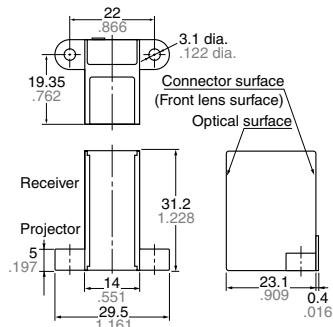

# MA Motion Sensor (AMA1, AMB1, 2, 3)

## 4) Long type (H)

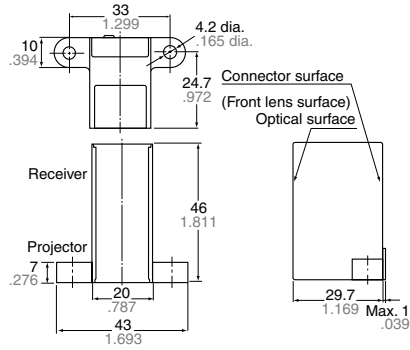

## Long type (V)

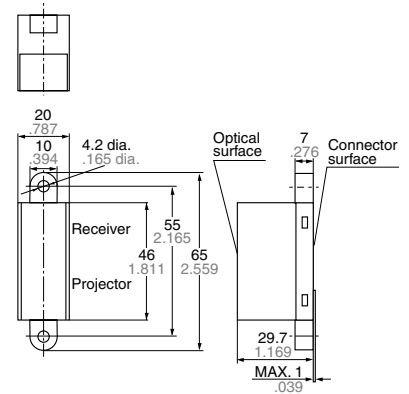

## WIRING DIAGRAM (Connector surface view)

### 1) Thin short type (V)

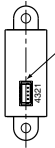

BM04B-SRSS  
(J.S.T. Mfg. Co., Ltd.)

- 1: Output
  - 2: GND
  - 3: Power source
  - 4: Built-in oscillation circuit type: N.C.
- External triggering type:  
external trigger input

### 2) Short type (H)

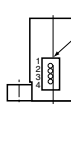

IL-Z-4P-S125L3-E  
(Japan Aviation Electronics Industry, Limited)

- 1: Output
  - 2: GND
  - 3: Power source
  - 4: Built-in oscillation circuit type: N.C.
- External triggering type:  
external trigger input

### 3) Middle type (H)

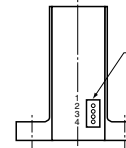

IL-Z-4P-S125T3-E  
(Japan Aviation Electronics Industry, Limited)

- 1: Output
  - 2: GND
  - 3: Power source
  - 4: Built-in oscillation circuit type: N.C.
- External triggering type:  
external trigger input

## 4) Long type (H)

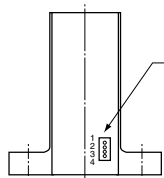

IL-Z-4P-S125T3-E  
(Japan Aviation Electronics Industry, Limited)

- 1: Output
  - 2: GND
  - 3: Power source
  - 4: Built-in oscillation circuit type: N.C.
- External triggering type:  
external trigger input

## Long type (V)

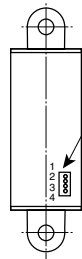

IL-Z-4P-S125T3-E  
(Japan Aviation Electronics Industry, Limited)

- 1: Output
  - 2: GND
  - 3: Power source
  - 4: Built-in oscillation circuit type: N.C.
- External triggering type:  
external trigger input

Notes: Purchase the following connections:

1. Socket housing IL-Z-4S-S125C3  
(Japan Aviation Electronic Industry, Ltd.)
2. Lead wire (with metal connector at one end)

## OPTIONAL

mm inch

### 1. Connector with cable (for AMB series)

AMV9001

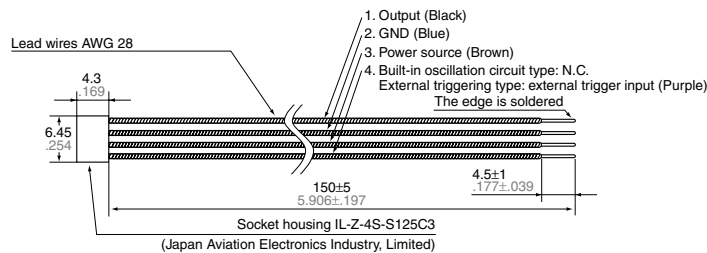

Note: Mistaken cable assembly can cause damage to the internal circuits, so please check the power cord before switching ON. (Particular care must be taken as to avoid reverse connection of the power.)

\*Connectors with cable for thin short type are handled as "U orders".

# MA Motion Sensor (AMA1, AMB1, 2, 3)

## NOTES

### 1. Environment

- 1) Avoid using the sensor in environments containing excessive amounts of steam, dust, corrosive gas, or where organic solvents are present.
- 2) When the sensor is used in noisy environments, connect a capacitor (minimum 33  $\mu$ F) across its power input terminals.

### 2. Wiring

- 1) Check all wiring before applying power. Incorrect wiring may damage the internal circuit (in particular, check that the connection to the power supply is not reversed.)
- 2) Avoid excessive removing and replacing of the connector.

### 3. Detector surface (Optical surface)

- 1) Keep the detector surface clean. Excessive dust or dirt on the detector surface will deteriorate the sensing performance.
- 2) Do not allow condensation or freezing to occur on the surface of the sensor. If condensation or freezing does occur at low temperatures, the sensor may not detect objects correctly.

3) This product is designed to detect the existence of human body. The sensor will not detect objects consisting of a low reflective material (e.g., an object coated with black rubber, etc.) or of a highly reflective material (e.g., mirror, glass, coated paper, etc.)

4) The front surface of the lens and case are made of polycarbonate resin and can withstand water, alcohol, oils, salts and weak acids. Other fluids such as alkalines, aromatic hydrocarbons and halogenated hydrocarbons may melt or swell the lens and case, please do not have such fluids touch the lens and case.

5) If you use the sensor with a cover or filter connected to the front of the sensor, the sensor may detect the cover itself, the detection distance can change, and unstable operation can result.

6) When multiple sensors are to be used side by side, please verify that there will be no mutual interference by installing them with the proper spacing, depending on the type as shown below.

Model number	Sensor spacing
AMB1 series	5 cm 1.969 inch
AMA1 series	8 cm 3.150 inch
AMB2 series	10 cm 3.937 inch
AMB3 series	20 cm 7.874 inch

7) To protect the inner circuit, wiring should be max. 3 m 9.843 ft..

### 4. Recommended installation procedure

Install the photoelectric sensor so that it is orientated correctly in relation to the pass directions of the target objects as shown in the figure below.

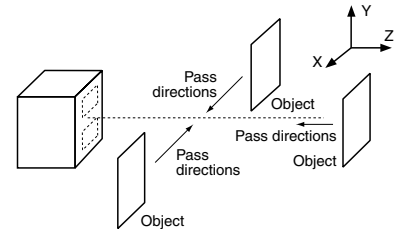

\* → stands for pass direction of the target object.

For the general precautions, refer to the Notes for Motion Sensors on next page.