

A-Series

CIRCUIT BREAKER

Well known for their proven reliability, Carling Technologies' A-Series hydraulic magnetic circuit breakers are compact, temperature stable and designed for precision operation in OEM markets requiring general purpose as well as full load amp applications. When front panel operation and aesthetics demand a clean, contemporary design, the visi-rocker or paddle actuators are ideally suitable. A sealed toggle actuator style is also available and ideal for harsh environment applications requiring additional sealing protection. Optional rocker-guard and push-to-reset bezels, which help prevent inadvertent actuation, are also available.

1-6 poles; ratings from 0.02 to 50 amps, up to 277VAC or 80VDC; UL Recognized, UL Listed, UL1500, UL1077, TUV, VDE & CSA

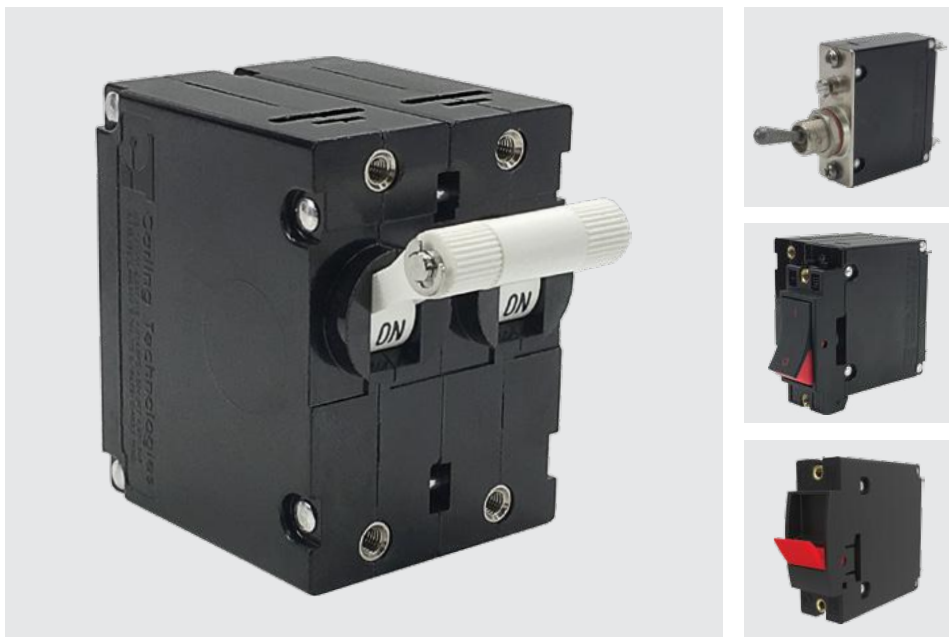

Product Highlights:

- ♦ Up to 50 amps in a compact size
- ♦ Various actuator styles
- ♦ Sealed metal toggle option tested to MIL-PRF-55629C. Meets IP68 Requirements

Typical Applications:

- ♦ Telecom/Datacom
- ♦ Marine
- ♦ Military
- ♦ Renewable Energy
- ♦ Generators & Welder



Electrical

Maximum Voltage 277VAC 50/60 Hz, 80VDC
 Current Ratings Standard current coils: 0.100, 0.250, 0.500, 0.750, 1.00, 2.50, 5.00, 7.50, 10.0, 15.0, 20.0, 25.0, 30.0, 35.0, 40.0, 50.0. Other ratings available - consult ordering scheme.
 Standard Voltage Coils DC-6V, 12V; AC-120V, Other ratings available, consult ordering scheme.
 Auxiliary Switch Rating SPDT; 10.1 A - 250VAC, 1.0 A-65VDC/0.5 A - 80 VDC, 0.1A - 125VAC (with gold contacts).
 Insulation Resistance Minimum: 100 Megohms at 500 VDC
 Dielectric Strength UL, CSA - 1500V 60 Hz for one minute between all electrically isolated terminals. A-Series rocker circuit breakers comply with the 8mm spacing & 3750V dielectric requirements from hazardous voltage to operator accessible surfaces per EN 60950 and VDE 0805.
 Resistance, Impedance Values from Line to Load Terminal - based on Series Trip Circuit Breaker.

Mechanical

Endurance 10,000 ON-OFF operations @ 6 per minute; with rated Current & Voltage.
 Trip Free All A-Series Circuit Breakers will trip on overload, even when the actuator is forcibly held in the ON position.
 Trip Indication The operating actuator moves positively to the OFF position when an overload causes the circuit breaker to trip. When mid-trip handle is specified, the handle moves to the mid position on electrical trip of the circuit breaker. When mid-trip handle with alarm switch is specified, the handle moves to the mid position & the alarm switch actuates when the circuit breaker is electrically tripped.

Physical

Number of Poles 1 - 6 Poles (handle) and 1-3 poles (rocker) at 30 Amps or less. 1 and 2 poles at 31 Amps thru 50 Amps.
 Internal Circuit Config. Series, (with or without auxiliary switch), Shunt and Relay with current or voltage trip coils, Dual Coil, Switch Only with or without auxiliary switch.
 Weight Approximately 65 grams/pole. (Approximately 2.32 ounces/pole)
 Standard Colors Housing - Black; Actuator- See Ordering Scheme.

Environmental

Designed and tested in accordance with requirements of specification MIL-PRF-55629 & MIL-STD-202 as follows:
 Shock Withstands 100 Gs, 6ms, sawtooth while carrying rated current per Method 213, Test Condition "I". Instantaneous and ultra-short curves tested @ 90% of rated current.
 Vibration Withstands 0.060" excursion from 10-55 Hz, and 10 Gs 55-500 Hz, at rated current per Method 204C, Test Condition A. Instantaneous and ultrashort curves tested at 90% of rated current.
 Moisture Resistance Method 106D; ten 24-hour cycles @ + 25°C to +65°C, 80-98% RH.56 days @ +85°C, 85% RH.
 Salt Spray Method 101, Condition A (90-95% RH @ 5% NaCl Solution, 96 hrs).
 Thermal Shock Method 107D, Condition A (Five cycles @ -55°C to +25°C to +85°C to +25°C).
 Operating Temperature -40° C to +85° C

RESISTANCE PER POLE VALUES from Line to Load Terminals (Values Based on Series Trip Circuit Breaker)

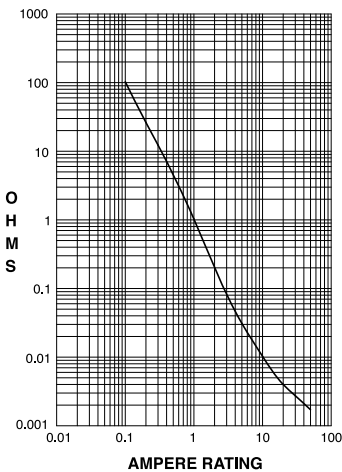

| CURRENT (AMPS) | TOLERANCE (%) |
|----------------|---------------|
| 0.10 - 5.0 | 15 |
| 5.1 - 20.0 | 25 |
| 20.1 - 50.0 | 35 |

Pulse Tolerance Curves

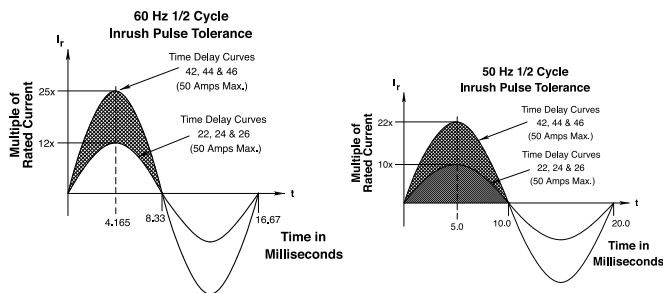

*Manufacturer reserves the right to change product specification without prior notice.

Electrical Tables

Table A: Lists UL Recognized & CSA Accepted configurations and performance capabilities as a Component Supplementary Protector.

| A-SERIES TABLE A: COMPONENT SUPPLEMENTARY PROTECTORS | | | | | | | | | | | |
|--|------------|-----------|----------------|----------------|----------------------|-------------------------------|---------------------|-------------------|-----------------|--------------------|-----------------|
| Circuit Configuration | Voltage | | | Current Rating | | Short Circuit Capacity (Amps) | | Application Codes | | Construction Notes | |
| | Max Rating | Frequency | Phase | Full Load Amps | General Purpose Amps | UL / CSA | | UL | CSA | | |
| | | | | | | With Backup Fuse | Without Backup Fuse | | | | |
| Series | 32 | DC | --- | 0.02 - 15 | --- | --- | 5000 | TC1, OL1, U2 | TC1, OL1, U2 | | |
| | 65 | DC | --- | 31 - 50 | --- | --- | 7500 | TC1, 2, OL1, U1 | TC1, 2, OL1, U1 | | |
| | 80 | DC | --- | 0.02 - 30 | --- | --- | 7500 | TC1, 2, OL1, U1 | TC1, 2, OL1, U1 | | |
| | | | | --- | 31 - 50 | --- | 7500 | TC1, 2, OL0, U1 | TC1, 2, OL0, U1 | | |
| | 125 | 50 / 60 | 1 | 0.02 - 30 | --- | --- | 3000 | TC1, OL1, U2 | TC1, OL1, U2 | Rocker Version | |
| | 125 | 50 / 60 | 1 | 1 - 50 | --- | --- | 2000 | TC1, OL1, U2 | TC1, OL1, U2 | | |
| | 125 | 50 / 60 | 1 ⁴ | 1 - 50 | --- | --- | 1000 | TC1, OL1, U2 | TC3, OL1, U3 | | |
| | 125 / 250 | 50 / 60 | 1 ³ | 0.02 - 30 | --- | --- | 3000 | TC1, 2, OL1, U2 | TC1, 2, OL1, U2 | Rocker Version | |
| | 125 / 250 | 50 / 60 | 1 ³ | 0.02 - 50 | --- | --- | 3000 | TC1, 2, OL1, U2 | TC1, 2, OL1, U2 | Handle | |
| | 250 | 50 / 60 | 1 | 0.02 - 30 | --- | --- | 1500 | TC1, 2, OL0, U2 | TC1, 2, OL0, U2 | Single Pole Break | |
| | | | | 0.02 - 30 | --- | --- | 3000 | TC1, OL1, U2 | TC1, OL1, U2 | Two Pole Break | |
| | | | | --- | --- | --- | 3000 | TC1, 2, OL0, U1 | TC1, 2, OL0, U1 | | |
| | | | | 1 ⁴ | 1 - 50 | --- | 1000 | TC1, OL1, U2 | TC3, OL1, U3 | | |
| | | | | 3 | 0.02 - 30 | --- | 5000 ² | --- | --- | TC1, 2, OL1, C1 | TC1, 2, OL1, C1 |
| | | | 31 - 50 | --- | --- | 2000 ¹ | --- | TC1, 2, OL1, C1 | TC1, 2, OL1, C1 | | |
| 277 | 50 / 60 | 1 | 0.02 - 30 | --- | --- | 5000 ¹ | --- | TC1, 2, OL1, C1 | TC1, 2, OL1, C1 | | |
| Dual Coil | 32 | DC | --- | 0.02 - 50 | --- | --- | 5000 | TC1, OL1, U2 | TC1, OL1, U2 | | |
| | 65 | DC | --- | 0.02 - 50 | --- | --- | 7500 | TC1, 2, OL1, U1 | TC1, 2, OL1, U1 | | |
| | 80 | DC | --- | 0.02 - 30 | --- | --- | 7500 | TC1, 2, OL1, U1 | TC1, 2, OL1, U1 | | |
| | | | | --- | 31 - 50 | --- | 7500 | TC1, 2, OL0, U1 | TC1, 2, OL0, U1 | | |
| | 125 | 50 / 60 | 1 | 0.02 - 30 | --- | --- | 3000 | TC1, OL1, U2 | TC1, OL1, U2 | Rocker Version | |
| | | | | 1 - 50 | --- | --- | 2000 | TC1, OL1, U2 | TC1, OL1, U2 | | |
| | 125 | 50 / 60 | 1 ⁴ | 0.02 - 30 | --- | --- | 1000 | TC1, OL1, U2 | TC3, OL1, U3 | | |
| | 125 / 250 | 50 / 60 | 1 ³ | 0.02 - 30 | --- | --- | 3000 | TC1, 2, OL1, U1 | TC1, 2, OL1, U1 | Rocker Version | |
| | 125 / 250 | 50 / 60 | 1 ³ | 0.02 - 50 | --- | --- | 3000 | TC1, 2, OL1, U2 | TC1, 2, OL1, U2 | | |
| | 250 | 50 / 60 | 1 | 0.02 - 30 | --- | --- | 1500 | TC1, OL0, U2 | TC1, OL0, U2 | Single Pole Break | |
| | | | | 0.02 - 30 | --- | --- | 3000 | TC1, OL1, U2 | TC1, OL1, U2 | Two Pole Break | |
| | | | | --- | 31 - 50 | --- | 3000 | TC1, 2, OL0, U1 | TC1, 2, OL0, U1 | | |
| | | | | 1 ⁴ | 1 - 50 | --- | 1000 | TC1, OL1, U2 | TC3, OL1, U3 | | |
| | | | | 3 | 0.02 - 30 | --- | 5000 ² | --- | --- | TC1, 2, OL1, C1 | TC1, 2, OL1, C1 |
| | | | 31 - 50 | --- | --- | 2000 ¹ | --- | TC1, 2, OL1, C1 | TC1, 2, OL1, C1 | | |
| 277 | 50 / 60 | 1 | 0.02 - 30 | --- | --- | 5000 ¹ | --- | TC1, 2, OL1, U1 | TC1, 2, OL1, U1 | | |
| Shunt | 80 | DC | --- | 0.02 - 30 | --- | --- | 7500 | TC1, 2, OL1, U1 | TC1, 2, OL1, U1 | | |
| | 125 / 250 | 50 / 60 | 1 | 0.02 - 30 | --- | --- | 3000 | TC1, 2, OL1, U1 | TC1, 2, OL1, U1 | | |
| | | | | 0.02 - 30 | --- | --- | 3000 | TC1, 2, OL1, U1 | TC1, 2, OL1, U1 | | |
| | 250 | 50 / 60 | 3 | 0.02 - 30 | --- | --- | 5000 ² | --- | TC1, 2, OL1, C1 | TC1, 2, OL1, C1 | |
| | | | | 0.02 - 30 | --- | --- | 5000 ² | --- | --- | --- | TC1, 2, OL1, C1 |
| 277 | 50 / 60 | 1 | 0.02 - 30 | --- | --- | 5000 ¹ | --- | TC1, 2, OL1, C1 | TC1, 2, OL1, C1 | | |
| Relay | 80 | DC | --- | 0.02 - 30 | --- | --- | 7500 | TC1, 2, OL1, U1 | TC1, 2, OL1, U1 | | |
| | 125 / 250 | 50 / 60 | 1 ³ | 0.02 - 30 | --- | --- | 3000 | TC1, 2, OL1, U1 | TC1, 2, OL1, U1 | | |
| | | | | 0.02 - 30 | --- | --- | 3000 | TC1, 2, OL1, U1 | TC1, 2, OL1, U1 | | |
| | 250 | 50 / 60 | 3 | 0.02 - 30 | --- | --- | 5000 ² | --- | TC1, 2, OL1, C1 | TC1, 2, OL1, C1 | |
| | | | | 0.02 - 30 | --- | --- | 5000 ² | --- | --- | --- | TC1, 2, OL1, C1 |
| 277 | 50 / 60 | 1 | 0.02 - 30 | --- | --- | 5000 ¹ | --- | TC1, 2, OL1, C1 | TC1, 2, OL1, C1 | | |
| Switch Only | 65 | DC | --- | 0.02 - 50 | --- | not applicable | | | | | |
| | 80 | DC | --- | 0.02 - 30 | --- | | | | | | |
| | 250 | 50 / 60 | 1 | --- | 31 - 50 | | | | | | |
| | | | 3 | 0.02 - 50 | --- | | | | | | |
| | 277 | 50 / 60 | 1 | 0.02 - 30 | 31 - 50 | | | | | | |

Notes:
 1 Requires branch circuit backup with a UL LISTED Type K5 or RK5 fuse (15A minimum) at no more than 4 times the rating of the protector.
 2 Same as note 1, except that backup fuse is limited to 80 A maximum.
 3 2 pole protector required (with one pole per power line) for: 125/250 VAC, 1 pole protector required for: 125 VAC, 1Ø Power System.
 4 Satisfies the requirements of clause 11.2.8.2.5 of CSA STD C22.2 No 100 for the use of supplementary protectors with portable generators.

Electrical Tables

Table B: Lists UL Recognized, CSA Accepted, VDE & TUV Certified configurations & performance capabilities as a Component Supplementary Protector.

| A-SERIES TABLE B: COMPONENT SUPPLEMENTARY PROTECTORS | | | | | | | | | | | | | | | | |
|--|-------------|-----------|-------------------|----------------|-----------------------------------|-------------------------------|---------------------|------------------------|----------------------|------------------------|----------------------------|-------------------|---------------|-------------------------------|----------------------------|----------------------------|
| CIRCUIT CONFIGURATION | VOLTAGE | | | CURRENT RATING | | SHORT CIRCUIT CAPACITY (AMPS) | | | | | | APPLICATION CODES | | VDE CONSTRUCTION NOTES | | |
| | MAX. RATING | FREQUENCY | PHASE | FULL LOAD AMPS | GENERAL PURPOSE AMPS ¹ | UL/CSA | | VDE | | TUV | | UL | CSA | | | |
| | | | | | | WITH BACKUP FUSE | WITHOUT BACKUP FUSE | (Inc) WITH BACKUP FUSE | (Inc) WITHOUT BACKUP | (Inc) WITH BACKUP FUSE | (Inc) WITHOUT BACKUP | | | | | |
| SERIES | 65 | DC | — | 0.10 - 50 | — | — | 7500 | — | — | 5000 | 3000 | TC1,2, OL1,U1 | TC1,2, OL1,U1 | World Market Breaker TUV Only | | |
| | 80 | DC | — | 0.10 - 30 | — | — | 7500 | 3000 | 1500 | 3000 | 1500 | TC1,2, OL1,U1 | TC1,2, OL1,U1 | Handle Version 1 Pole Only | | |
| | | | | 31 - 50 | 31 - 50 | — | 7500 | 3000 | 1500 | 3000 | 1500 | TC1,2, OL0,U1 | TC1,2, OL0,U1 | Handle Version 1 Pole Only | | |
| | | | | 0.10 - 30 | — | — | 7500 | 3000 | 1500 | 3000 | 1500 | TC1,2, OL1,U1 | TC1,2, OL1,U1 | Rocker Version 1 - 3 Poles | | |
| | | | | 31 - 32 | — | — | 7500 | 3000 | 1500 | 3000 | 1500 | TC1,2, OL1,U1 | TC1,2, OL1,U1 | Rocker Version 2 Pole Only | | |
| | | | | 31 - 50 | 31 - 50 | — | 7500 | 3000 | 1500 | 3000 | 1500 | TC1,2, OL0,U1 | TC1,2, OL0,U1 | Rocker Version 1 Pole Only | | |
| | 250 | 50 / 60 | 1 | 0.10 - 30 | — | — | 3000 | 3000 | 1500 | 5000 | 1500 | TC1,2, OL1,U1 | TC1,2, OL1,U1 | Rocker Version 1 - 3 Poles | | |
| | | | | 31 - 50 | 31 - 50 | — | 3000 | — | — | 5000 | 1500 | TC1,2, OL0,U1 | TC1,2, OL0,U1 | Rocker Version 1 - 3 Poles | | |
| | | | | 31 - 32 | — | — | 3000 | 6000 | 1500 | 5000 | 1500 | TC1,2, OL1,U1 | TC1,2, OL1,U1 | Rocker Version 2 Pole Only | | |
| | | | | 1 | 0.10 - 30 | — | — | 3000 | 6000 | 1500 | 5000 | 1500 | TC1, OL1,U2 | TC1, OL1,U2 | Rocker Version 2 Pole Only | |
| | | | | 1 ⁴ | 1 - 50 | — | — | 1000 | — | — | 5000 | 1500 | TC1, OL1,U2 | TC3, OL1,U3 | Rocker Version 1 - 3 Poles | |
| | | | | 3 | 0.10 - 30 | — | — | 5000 ³ | — | 3000 | 1500 | 3000 | 1500 | TC1,2, OL1,C1 | TC1,2, OL1,C1 | Rocker Version 1 - 3 Poles |
| | | | | 31 - 50 | — | — | 2000 ² | — | 3000 | 1500 | 3000 | 1500 | TC1,2, OL1,C1 | TC1,2, OL1,C1 | Rocker Version 1 - 3 Poles | |
| | DUAL COIL | 80 | DC | — | 0.10 - 30 | — | — | 7500 | 3000 | 1500 | 3000 | 1500 | TC1,2, OL1,U1 | TC1,2, OL1,U1 | Rocker Version 1 - 3 Poles | |
| 250 | | 50 / 60 | 1 | 0.10 - 30 | — | — | 3000 | 3000 | 1500 | 5000 | 1500 | TC1,2, OL1,U1 | TC1,2, OL1,U1 | Rocker Version 1 - 3 Poles | | |
| | | | | 30 - 50 | 31 - 50 | — | 3000 | — | — | 5000 | 1500 | TC1,2, OL0,U1 | TC1,2, OL0,U1 | Rocker Version 1 - 3 Poles | | |
| | | | | 3 | 0.10 - 30 | — | — | 5000 ³ | — | 3000 | 1500 | 3000 | 1500 | TC1,2, OL1,C1 | TC1,2, OL1,C1 | Rocker Version 1 - 3 Poles |
| 31 - 50 | — | — | 2000 ² | — | — | — | 3000 | 1500 | TC1,2, OL1,C1 | TC1,2, OL1,C1 | Rocker Version 1 - 3 Poles | | | | | |
| SHUNT | 80 | DC | — | 0.10 - 30 | — | — | 7500 | 3000 | 1500 | 3000 | 1500 | TC1,2, OL1,U1 | TC1,2, OL1,U1 | Handle Version 1 Pole Only | | |
| | | | | 0.10 - 30 | — | — | 7500 | 3000 | 1500 | 3000 | 1500 | TC1,2, OL1,U1 | TC1,2, OL1,U1 | Rocker Version 1 - 3 Poles | | |
| | 250 | 50 / 60 | 1 | 0.10 - 30 | — | — | 3000 | 3000 | 1500 | 5000 | 1500 | TC1,2, OL1,U1 | TC1,2, OL1,U1 | Rocker Version 1 - 3 Poles | | |
| | | | | 30 - 50 | 31 - 50 | — | 3000 | — | — | 5000 | 1500 | TC1,2, OL0,U1 | TC1,2, OL0,U1 | Rocker Version 1 - 3 Poles | | |
| | | | | 3 | 0.10 - 30 | — | — | 5000 ³ | — | 3000 | 1500 | 3000 | 1500 | TC1,2, OL1,C1 | TC1,2, OL1,C1 | Rocker Version 1 - 3 Poles |
| | | | | 31 - 50 | — | — | 2000 ² | — | — | — | 3000 | 1500 | TC1,2, OL1,C1 | TC1,2, OL1,C1 | Rocker Version 1 - 3 Poles | |

Notes:

- 1 General Purpose Ratings for UL/CSA Only.
- 2 Requires branch circuit backup with a UL LISTED Type K5 or RK5 fuse (15A minimum) at no more than 4 times the rating of the protector.
- 3 Same as note 2, except that backup fuse is limited to 80 A maximum.
- 4 Satisfies the requirements of clause 11.2.8.2.5 of CSA STD C22.2 No 100 for the use of supplementary protectors with portable generators.

Electrical Tables

Table C: Lists UL Recognized, CSA Accepted configurations and performance capabilities as Protectors, Supplementary for Marine Electrical and Fuel Systems (Guide PEQZ2, File E75596). Ignition Protected per UL 1500. UL Classified Small Craft Electrical Devices, Marine in accordance with ISO 8846 (Guide UZMK, File MQ1515) as Marine Supplementary Protectors.

| A-SERIES TABLE C: UL1500 (Marine Ignition Protected) | | | | | | | |
|--|-----------------|-----------|----------------|----------------|-------------------------------|-------------------|------------|
| CIRCUIT CONFIGURATION | VOLTAGE | | | CURRENT RATING | SHORT CIRCUIT CAPACITY (AMPS) | APPLICATION CODES | |
| | MAX. RATING | FREQUENCY | PHASE | FULL LOAD AMPS | WITHOUT BACKUP FUSE | UL | CSA |
| SERIES | 14 ¹ | DC | --- | 0.02 - 50 | 5000 | TC1,OL1,U1 | TC1,OL1,U1 |
| | 32 ¹ | DC | --- | 0.02 - 50 | 5000 | TC1,OL1,U2 | TC1,OL1,U2 |
| | 65 | DC | --- | 0.02 - 50 | 3000 | TC1,OL1,U1 | TC1,OL1,U1 |
| | 125 | 50 / 60 | 1 | 0.02 - 50 | 3000 | TC1,OL1,U2 | TC1,OL1,U2 |
| | 125 / 250 | 50 / 60 | 1 ² | 0.02 - 50 | 3000 | TC1,OL1,U2 | TC1,OL1,U2 |
| | 250 | 50 / 60 | 1 | 0.02 - 30 | 1500 | TC1,OL1,U1 | TC1,OL1,U1 |

Notes:

1 Available with special catalog number only (consult factory).

2 2 pole protector required (with one per power line) for 125 / 250 VAC. 1 pole protector required for 125 VAC 1 phase power system

Table D: Lists UL Listed configurations and performance capabilities as Circuit Breakers for use in Communications Equipment (Guide DITT, File E189195), under UL489A.

| A-SERIES TABLE D: UL489A (COMMUNICATIONS EQUIPMENT) | | | | |
|---|-------------|-----------|----------------------|------------------------------|
| CIRCUIT CONFIGURATION | VOLTAGE | | CURRENT RATING | INTERRUPTING CAPACITY (AMPS) |
| | MAX. RATING | FREQUENCY | GENERAL PURPOSE AMPS | WITHOUT BACKUP FUSE |
| SERIES | 80 | DC | 0.10 - 50 | 5000 |
| | 80 | DC | 60 - 90 ¹ | 5000 |

Notes:

1 Parallel Pole Construction

Agency Certifications

UL Recognized

UL Standard 1077



Component Recognition Program as Protectors Supplementary (Guide CCN/QVNU2, File E75596)

UL Standard 508



Switches, Industrial Control (Guide CCN/NRNT2, File E148683)

UL Standard 1500



Protectors, Supplementary for Marine Electrical & Fuel Systems (Guide PEQZ2, File E75596) Ignition Protection

UL Listed

UL Standard 489A



Communications Equipment (Guide CCN/DITT, File E189195)

CSA Accepted



Component Supplementary Protector under Class 3215 30, File 047848 0 000 CSA Standard C22.2 No. 235

TUV Certified



EN60934, under License No. R72103448

VDE Certified



EN60934, VDE 0642 under File No. 10537

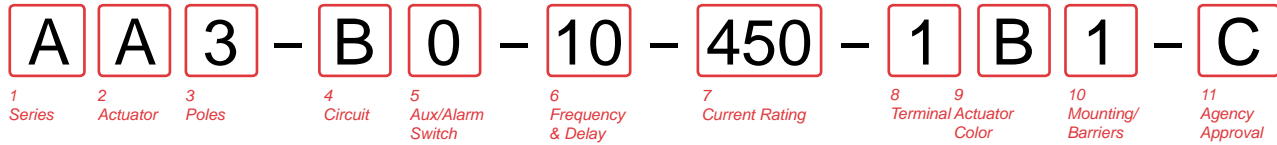

1 SERIES

A

2 ACTUATOR 1

- A** Handle, one per pole
- B** Handle, one per multipole unit
- S** Mid-Trip Handle, one per pole
- T** Mid-Trip Handle, one per pole & Alarm Switch

3 POLES

- | | | |
|--------------|----------------|---------------|
| 1 One | 3 Three | 5 Five |
| 2 Two | 4 Four | 6 Six |

4 CIRCUIT

- | | |
|---|--|
| A ² Switch Only (No Coil) | F ³ Relay Trip (Current) |
| B Series Trip (Current) | G ³ Relay Trip (Voltage) |
| C Series Trip (Voltage) | H ^{3,4} Dual Coil with Shunt Trip Voltage Coil |
| D ³ Shunt Trip (Current) | K ^{3,4} Dual Coil with Relay Trip Voltage Coil |
| E ³ Shunt Trip (Voltage) | |

5 AUXILIARY / ALARM SWITCH 5

- | | |
|---|---|
| 0 without Aux Switch | 5 S.P.S.T., 0.093 Q.C. Term. (Gold Contacts) |
| 1 S.P.D.T., 0.093 Q.C. Term. | 7 S.P.S.T., 0.110 Q.C. Term. (Gold Contacts) |
| 2 S.P.D.T., 0.110 Q.C. Term. | 8 S.P.S.T., 0.187 Q.C. Term. (Gold Contacts) |
| 4 S.P.D.T., 0.110 Q.C. Term. (Gold Contacts) | 9 S.P.D.T., 0.187 Q.C. Term. |

6 FREQUENCY & DELAY

- | | |
|-----------------------------------|--|
| 03 DC 50/60Hz, Switch Only | 30 DC, 50/60Hz Instantaneous |
| 10 DC Instantaneous | 31 DC, 50/60Hz Ultra Short |
| 11 DC Ultra Short | 32 DC, 50/60Hz Short |
| 12 DC Short | 34 DC, 50/60Hz Medium |
| 14 DC Medium | 36 DC, 50/60Hz Long |
| 16 DC Long | 42 ⁷ 50/60Hz Short, Hi-Inrush |
| 20 50/60Hz Instantaneous | 44 ⁷ 50/60Hz Medium, Hi-Inrush |
| 21 50/60Hz Ultra Short | 46 ⁷ 50/60Hz Long, Hi-Inrush |
| 22 50/60Hz Short | 52 ⁷ DC, Short, Hi-Inrush |
| 24 50/60Hz Medium | 54 ⁷ DC, Medium, Hi-Inrush |
| 26 50/60Hz Long | 56 ⁷ DC, Long, Hi-Inrush |

7 CURRENT RATING (AMPERES)

| CODE | AMPERES | | | | | | |
|------------|---------|------------|-------|------------|--------|-------------------------|--------|
| 020 | 0.020 | 225 | 0.250 | 420 | 2.000 | 611 | 11.000 |
| 025 | 0.025 | 230 | 0.300 | 522 | 2.250 | 711 | 11.500 |
| 030 | 0.030 | 235 | 0.350 | 527 | 2.750 | 612 | 12.000 |
| 035 | 0.035 | 240 | 0.400 | 430 | 3.000 | 712 | 12.500 |
| 040 | 0.040 | 245 | 0.450 | 435 | 3.500 | 613 | 13.000 |
| 045 | 0.045 | 250 | 0.500 | 440 | 4.000 | 614 | 14.000 |
| 050 | 0.050 | 255 | 0.550 | 445 | 4.500 | 615 | 15.000 |
| 055 | 0.055 | 260 | 0.600 | 450 | 5.000 | 616 | 16.000 |
| 060 | 0.060 | 265 | 0.650 | 455 | 5.500 | 617 | 17.000 |
| 065 | 0.065 | 270 | 0.700 | 460 | 6.000 | 618 | 18.000 |
| 070 | 0.070 | 275 | 0.750 | 465 | 6.500 | 620 | 20.000 |
| 075 | 0.075 | 280 | 0.800 | 470 | 7.000 | 622 | 22.000 |
| 080 | 0.080 | 285 | 0.850 | 475 | 7.500 | 624 | 24.000 |
| 085 | 0.085 | 290 | 0.900 | 480 | 8.000 | 625 | 25.000 |
| 090 | 0.090 | 295 | 0.950 | 485 | 8.500 | 630 | 30.000 |
| 095 | 0.095 | 410 | 1.000 | 490 | 9.000 | 635 ⁸ | 35.000 |
| 210 | 0.100 | 512 | 1.250 | 495 | 9.500 | 640 ⁸ | 40.000 |
| 215 | 0.150 | 415 | 1.500 | 610 | 10.000 | 645 ⁸ | 45.000 |
| 220 | 0.200 | 517 | 1.750 | 710 | 10.500 | 650 ⁸ | 50.000 |

OR VOLTAGE COIL (NORMAL RATED VOLTAGE) 6

| CODE | AMPERES | | | | |
|------------|---------|------------|-------|------------|--------|
| A06 | 6 DC | A32 | 32 DC | J12 | 12 AC |
| A12 | 12 DC | A48 | 48 DC | J18 | 18 AC |
| A18 | 18 DC | A65 | 65 DC | J24 | 24 AC |
| A24 | 24 DC | J06 | 6 AC | J48 | 48 AC |
| | | | | J65 | 65 AC |
| | | | | K20 | 120 AC |
| | | | | L40 | 240 AC |

8 TERMINAL 9

- | | |
|--|--|
| 1 ¹⁰ Push-On 0.250 Tab (Q.C.) | E ¹¹ Screw M4 (Bus Type) |
| 2 Screw 8-32 with upturned lugs | F Screw M5 with upturned lugs & 30° bend |
| 3 ¹¹ Screw 8-32 (Bus Type) | G Screw M5 (Bus Type) & 30° bend |
| 4 Screw 10-32 with upturned lugs | H ¹¹ Screw M5 (Bus Type) |
| 5 ¹¹ Screw 10-32 (Bus Type) | L ¹² 0.250 Q.C./ Solder Lug |
| 6 Screw 8-32 with upturned lugs & 30° bend | M ¹¹ M6 Threaded Stud |
| 7 Screw 8-32 (Bus Type) & 30° bend | Q ¹⁴ Push-In Stud |
| 8 Screw 10-32 with upturned lugs & 30° bend | R Screw M4 with upturned lugs & 30° bend |
| 9 Screw 10-32 (Bus Type) & 30° bend | T ¹¹ Screw M4 (Bus Type) & 30° bend |
| B Screw M5 with upturned lugs | P ¹³ Printed Circuit Board Terminals |
| C Screw M4 with upturned lugs | S ¹³ Push-On 0.110 Tab (Q.C.) |

9 ACTUATOR COLOR & LEGEND

| Actuator Color | I-O | ON-OFF | Dual | Legend Color |
|------------------------------------|----------|----------|----------|--------------|
| White | A | B | 1 | Black |
| Black | C | D | 2 | White |
| Red | F | G | 3 | White |
| Green | H | J | 4 | White |
| Blue | K | L | 5 | White |
| Yellow | M | N | 6 | Black |
| Gray | P | Q | 7 | Black |
| Orange | R | S | 8 | Black |
| Black (short handle) ¹⁵ | T | U | 9 | White |

10 MOUNTING / BARRIERS

| MOUNTING STYLE | BARRIERS |
|---|----------|
| Threaded Insert, 2 per pole | |
| 1 6-32 x 0.195 inches | no |
| A 6-32 x 0.195 inches | yes |
| 2 ISO M3 x 5mm | no |
| B ISO M3 x 5mm (multipole only) | yes |
| Front panel Snap-In, 0.75" wide bezel | |
| 5 without Handleguard | no |
| 6 without Handleguard (multipole only) | yes |
| Front panel Snap-In, 0.96" wide bezel | |
| 7 without Handleguard, 1-pole 0.96" wide; multipole units have .105" bezel overhang on all sides | no |
| 8 without Handleguard, 1-pole 0.96" wide; (multipole only) .105" bezel overhang on all sides | yes |

11 AGENCY APPROVAL

- C** UL Recognized & CSA Accepted
- D** VDE Certified, UL Recognized & CSA Accepted
- E** TUV Certified, UL Recognized & CSA Accepted
- I** UL Recognized STD 1077, UL Recognized 1500 (ignition protected), & CSA Accepted

Notes:

- 1 Actuator Code:
 - A: Handle tie pin spacer(s) and retainers provided un-assembled with multi-pole units.
 - B: Handle location as viewed from front of breaker:
 - 2 pole - left pole 3 pole - center pole 4 pole - two handles at center poles
 - 5 pole - three handles at center poles 6 pole - four handles at center poles
 - S: Handle moves to mid-position only upon electrical trip of the breaker. Available with circuit codes B, C, D, E, F, G, H and K.
 - T: Handle moves to mid-position and alarm switch activates only upon electrical trip of the breaker. Available with circuit codes B & C.
- 2 Switch Only circuits, rated up to 50 amps and 6 poles, and only available when tied to a protected pole (Circuit Code B, C, D or H). For .02 to 30 amps, select Current Code 630. For 35 - 50 amps, select Current Code 650.
- 3 Available with terminal Codes 1, 2 and 3. Current Rating limited to 50A amps maximum. Consult factory for available Dual Coil options, as special catalog number is required.
- 4 With Shunt construction, Dual Coils will trip instantaneously on line voltage. Dual coils require 30VA minimum power to trip and are rated for intermittent duty only.
- 5 Auxiliary Switch breakers with Series Trip & Switch Only circuits: ≤ 30A - supplied with standard half shells. 35-50A - supplied with extended boat (B-Style) half shells. On multi-pole breakers, one auxiliary switch is supplied, mounted in the extreme right pole.
- 6 Separate pole type voltage coils not rated for continuous duty. Available only with delay codes 10 and 20.
- 7 Available with Circuit Codes B & D only. VDE Certified to 30 amps. UL Recognized, CSA Accepted & TUV Certified to 50 amps.
- 8 VDE Certification available with single pole breakers with DC Delay only. UL Recognition and CSA Accepted available in one and two pole breakers.
- 9 Screw Terminals are recommended on ratings greater than 20 amps. Ratings over 30 amps are only available with Terminal Codes 5, 9, G, H, M and Q.
- 10 Terminal Code 1: VDE Certification up to 25 amps and UL Recognition and CSA Certification up to 30 amps, but not recommended over 20 amps.
- 11 Terminal Codes 3, 5, E and H (Bus Type) with VDE, are supplied with Lock Washers, and Terminal Code M (M6 Threaded Stud) with VDE is supplied with Lock and Flat Washers. These breakers are only VDE Certified when the washers are used.
- 12 Terminal Code L: VDE Certified available up to 12A. UL Recognized & CSA Accepted available up to 30A.
- 13 Single pole breakers with Terminal Code P (Printed Circuit Board) are available up to 30 amps with VDE Certification and 50 amps with UL Recognition and CSA Accepted, with Circuit Codes A, B and C. Two pole breakers with Terminal Code P (Printed Circuit Board) are available up to 40 amps with UL Recognition and CSA Accepted with Circuit Codes A, B and C.
- 14 Terminal Code Q not available with VDE certification.
- 15 Single pole only.

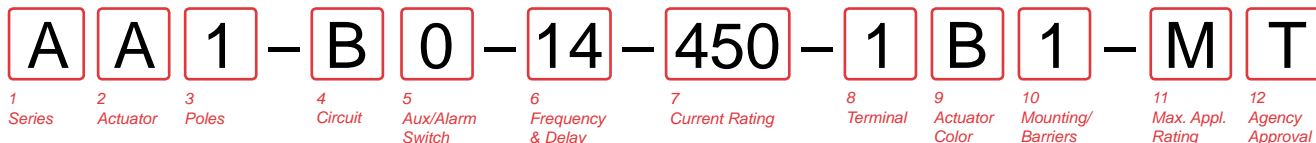

1 SERIES
A

2 ACTUATOR ¹
A Handle, one per pole
S Mid-Trip Handle, one per pole
T Mid-Trip Handle, one per pole & Alarm Switch

3 POLES ²
1 One
2 Two
3 Three
4 Four

4 CIRCUIT
B Series Trip (Current)

5 AUXILIARY/ALARM SWITCH ²
0 without Aux Switch
1 S.P.D.T., 0.093 Q.C. Term.
2 S.P.D.T., 0.110 Q.C. Term.

7 S.P.S.T., 0.110 Q.C. Term. (Gold Contacts)
8 S.P.S.T., 0.187 Q.C. Term.
9 S.P.D.T., 0.187 Q.C. Term.

6 FREQUENCY & DELAY
11 DC Ultra Short
12 DC Short
14 DC Medium
16 DC Long

52³ DC, Short, Hi-Inrush
54³ DC, Medium, Hi-Inrush
56³ DC, Long, Hi-Inrush

7 CURRENT RATING (AMPERES)

| CODE | AMPERES | | | | |
|------|---------|-----|-------|------------------|--------|
| 210 | 0.100 | 285 | 0.850 | 455 | 5.500 |
| 215 | 0.150 | 290 | 0.900 | 460 | 6.000 |
| 220 | 0.200 | 295 | 0.950 | 465 | 6.500 |
| 225 | 0.250 | 410 | 1.000 | 470 | 7.000 |
| 230 | 0.300 | 512 | 1.250 | 475 | 7.500 |
| 235 | 0.350 | 415 | 1.500 | 480 | 8.000 |
| 240 | 0.400 | 517 | 1.750 | 485 | 8.500 |
| 245 | 0.450 | 420 | 2.000 | 490 | 9.000 |
| 250 | 0.500 | 522 | 2.250 | 495 | 9.500 |
| 255 | 0.550 | 527 | 2.750 | 610 | 10.000 |
| 260 | 0.600 | 430 | 3.000 | 710 | 10.500 |
| 265 | 0.650 | 435 | 3.500 | 611 | 11.000 |
| 270 | 0.700 | 440 | 4.000 | 711 | 11.500 |
| 275 | 0.750 | 445 | 4.500 | 612 | 12.000 |
| 280 | 0.800 | 450 | 5.000 | 712 | 12.500 |
| | | | | 613 | 13.000 |
| | | | | 614 | 14.000 |
| | | | | 615 | 15.000 |
| | | | | 616 | 16.000 |
| | | | | 617 | 17.000 |
| | | | | 618 | 18.000 |
| | | | | 620 | 20.000 |
| | | | | 622 | 22.000 |
| | | | | 624 | 24.000 |
| | | | | 625 | 25.000 |
| | | | | 630 | 30.000 |
| | | | | 635 ³ | 35.000 |
| | | | | 640 ³ | 40.000 |
| | | | | 645 ³ | 45.000 |
| | | | | 650 ³ | 50.000 |

8 TERMINAL ⁵
1⁶ Push-On 0.250 Tab (Q.C.)
2 Screw 8-32 with upturned lugs
3⁷ Screw 8-32 (Bus Type)
4 Screw 10-32 with upturned lugs
5⁷ Screw 10-32 (Bus Type)
6 Screw 8-32 with upturned lugs & 30° bend
7 Screw 8-32 (Bus Type) & 30° bend
8 Screw 10-32 with upturned lugs & 30° bend

9 Screw 10-32 (Bus Type) & 30° bend
B Screw M5 with upturned lugs
F Screw M5 with upturned lugs & 30° bend
G Screw M5 (Bus Type) & 30° bend
H Screw M5 (Bus Type)
M⁷ M6 Threaded Stud
P⁸ Printed Circuit Board Terminals
Q⁹ Push-In Stud

9 ACTUATOR COLOR & LEGEND

| Actuator Color | ON-OFF | Dual | Legend Color |
|------------------------------------|--------|------|--------------|
| White | B | 1 | Black |
| Black | D | 2 | White |
| Red | G | 3 | White |
| Green | J | 4 | White |
| Blue | L | 5 | White |
| Yellow | N | 6 | Black |
| Gray | Q | 7 | Black |
| Orange | S | 8 | Black |
| Black (short handle) ¹⁰ | U | 9 | White |

10 MOUNTING / BARRIERS

| MOUNTING STYLE | BARRIERS |
|--|----------|
| Threaded Insert, 2 per pole | |
| 1 6-32 x 0.195 inches | no |
| A 6-32 x 0.195 inches | yes |
| 2 ISO M3 x 5mm | no |
| B ISO M3 x 5mm (multipole only) | yes |
| Front panel Snap-In, 0.75" wide bezel | |
| 5 without Handguard | no |
| 6 without Handguard (multipole only) | yes |
| Front panel Snap-In, 0.96" wide bezel | |
| 7 without Handguard, 1-pole 0.96" wide; | no |
| multipole units have .105" bezel overhang on all sides | |
| 8 without Handguard, 1-pole 0.96" wide; | yes |
| (multipole only) .105" bezel overhang on all sides | |

11 MAXIMUM APPLICATION RATING
M 80 DC

12 AGENCY APPROVAL
T UL489A Listed
K UL489A Listed, VDE Certified
J UL489A Listed, TUV Certified

- Notes:
- Actuator Code:
A: Handle tie pin spacer(s) and retainers provided un-assembled with multi-pole units.
S: Handle moves to mid-position only upon electrical trip of the breaker.
T: Handle moves to mid-position and alarm switch activates only upon electrical trip of the breaker.
 - On multi-pole breakers, one auxiliary switch is supplied, mounted in the extreme right pole.
 - VDE Certified to 30 amps. UL489A Listed to 50 amps.
 - VDE Certification available with single pole breakers only. UL489A Listing available with one and two pole breakers.
 - Screw Terminals are recommended on ratings greater than 20 amps. Ratings over 30 amps are only available with Terminal Codes 5, 9 G, H, M and Q.
 - Terminal Code 1 (Push-On) available up to 25 amps with VDE Certification and 30 amps with UL489A Listing, but is not recommended over 20 amps.
 - Terminal Codes 3, 5 and H (Bus Type) with VDE, are supplied with Lock Washers, and Terminal Code M (M6 Threaded Stud) with VDE is supplied with Lock and Flat Washers. These breakers are only VDE Certified when the washers are used.
 - Single pole breakers with Terminal Code P (Printed Circuit Board) are available up to 30 amps with VDE Certification and 50 amps with UL489A Listing.
 - Terminal Code Q not available with VDE certification.
 - Single pole only.

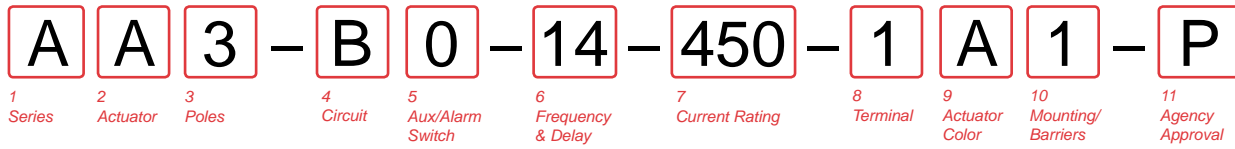

1 SERIES
A

2 ACTUATOR ¹
A Handle, one per pole
B Handle, one per multipole unit
S Mid-Trip Handle, one per pole
T Mid-Trip Handle, one per pole & Alarm Switch

3 POLES
1 One **3** Three **5** Five
2 Two **4** Four **6** Six

4 CIRCUIT
A² Switch Only (No Coil) **D**³ Shunt Trip (Current)
B Series Trip (Current) **E**³ Shunt Trip (Voltage)
C Series Trip (Voltage) **H**^{3,4} Dual Coil with Shunt Trip Voltage Coil

5 AUXILIARY / ALARM SWITCH ⁵
0 without Aux Switch
2 S.P.D.T., 0.110 Q.C. Term.
4 S.P.D.T., 0.110 Q.C. Term. (Gold Contacts)

6 FREQUENCY & DELAY
03 DC 50/60Hz, Switch Only **30** DC, 50/60Hz Instantaneous
10 DC Instantaneous **31** DC, 50/60Hz Ultra Short
11 DC Ultra Short **32** DC, 50/60Hz Short
12 DC Short **34** DC, 50/60Hz Medium
14 DC Medium **36** DC, 50/60Hz Long
16 DC Long **42**⁷ 50/60Hz Short, Hi-Inrush
20 50/60Hz Instantaneous **44**⁷ 50/60Hz Medium, Hi-Inrush
21 50/60Hz Ultra Short **46**⁷ 50/60Hz Long, Hi-Inrush
22 50/60Hz Short **52**⁷ DC, Short, Hi-Inrush
24 50/60Hz Medium **54**⁷ DC, Medium, Hi-Inrush
26 50/60Hz Long **56**⁷ DC, Long, Hi-Inrush

7 CURRENT RATING (AMPERES)

| CODE | AMPERES | CODE | AMPERES | CODE | AMPERES | | |
|------|---------|------|---------|------|---------|-----|--------|
| 210 | 0.100 | 285 | 0.850 | 455 | 5.500 | 613 | 13.000 |
| 215 | 0.150 | 290 | 0.900 | 460 | 6.000 | 614 | 14.000 |
| 220 | 0.200 | 295 | 0.950 | 465 | 6.500 | 615 | 15.000 |
| 225 | 0.250 | 410 | 1.000 | 470 | 7.000 | 616 | 16.000 |
| 230 | 0.300 | 512 | 1.250 | 475 | 7.500 | 617 | 17.000 |
| 235 | 0.350 | 415 | 1.500 | 480 | 8.000 | 618 | 18.000 |
| 240 | 0.400 | 517 | 1.750 | 485 | 8.500 | 620 | 20.000 |
| 245 | 0.450 | 420 | 2.000 | 490 | 9.000 | 622 | 22.000 |
| 250 | 0.500 | 522 | 2.250 | 495 | 9.500 | 624 | 24.000 |
| 255 | 0.550 | 527 | 2.750 | 610 | 10.000 | 625 | 25.000 |
| 260 | 0.600 | 430 | 3.000 | 710 | 10.500 | 630 | 30.000 |
| 265 | 0.650 | 435 | 3.500 | 611 | 11.000 | 635 | 35.000 |
| 270 | 0.700 | 440 | 4.000 | 711 | 11.500 | 640 | 40.000 |
| 275 | 0.750 | 445 | 4.500 | 612 | 12.000 | 645 | 45.000 |
| 280 | 0.800 | 450 | 5.000 | 712 | 12.500 | 650 | 50.000 |

OR VOLTAGE COIL (NORMAL RATED VOLTAGE) ⁶

| CODE | AMPERES | CODE | AMPERES | CODE | AMPERES | | |
|------|---------|------|---------|------|---------|-----|--------|
| A06 | 6 DC | A32 | 32 DC | J12 | 12 AC | J65 | 65 AC |
| A12 | 12 DC | A48 | 48 DC | J18 | 18 AC | K20 | 120 AC |
| A18 | 18 DC | A65 | 65 DC | J24 | 24 AC | L40 | 240 AC |
| A24 | 24 DC | J06 | 6 AC | J48 | 48 AC | | |

8 TERMINAL ⁹

| | |
|--|---|
| 1 ¹⁰ Push-On 0.250 Tab (Q.C.) | B Screw M5 with upturned lugs |
| 2 Screw 8-32 with upturned lugs | C Screw M4 with upturned lugs |
| 3 ¹¹ Screw 8-32 (Bus Type) | E ¹¹ Screw M4 (Bus Type) |
| 4 Screw 10-32 with upturned lugs | F Screw M5 with upturned lugs & 30° bend |
| 5 ¹¹ Screw 10-32 (Bus Type) | G Screw M5 (Bus Type) & 30° bend |
| 6 Screw 8-32 with upturned lugs & 30° bend | H ¹¹ Screw M5 (Bus Type) & 30° bend |
| 7 Screw 8-32 (Bus Type) & 30° bend | R Screw M4 with upturned lugs & 30° bend |
| 8 Screw 10-32 with upturned lugs & 30° bend | T ¹¹ Screw M4 (Bus Type) & 30° bend |
| 9 Screw 10-32 (Bus Type) & 30° bend | |

9 ACTUATOR COLOR & LEGEND

| Actuator Color | I-O | Dual | Legend Color |
|------------------------------------|-----|------|--------------|
| White | A | 1 | Black |
| Black | C | 2 | White |
| Red | F | 3 | White |
| Green | H | 4 | White |
| Blue | K | 5 | White |
| Yellow | M | 6 | Black |
| Gray | P | 7 | Black |
| Orange | R | 8 | Black |
| Black (short handle) ¹⁵ | T | 9 | White |

10 MOUNTING / BARRIERS

| MOUNTING STYLE | BARRIERS |
|---|----------|
| Threaded Insert, 2 per pole | |
| 1 6-32 x 0.195 inches | no |
| A 6-32 x 0.195 inches | yes |
| 2 ISO M3 x 5mm | no |
| B ISO M3 x 5mm (multipole only) | yes |
| Front panel Snap-In, 0.75" wide bezel | |
| 5 without Handleguard | no |
| 6 without Handleguard (multipole only) | yes |
| Front panel Snap-In, 0.96" wide bezel | |
| 7 without Handleguard, 1-pole 0.96" wide; multipole units have .105" bezel overhang on all sides | no |
| 8 without Handleguard, 1-pole 0.96" wide; (multipole only) .105" bezel overhang on all sides | yes |

11 AGENCY APPROVAL
P TUV Certified, UL Recognized & CSA Accepted
Q UL Recognized STD 1077, UL Recognized 1500 (ignition protected), & CSA Accepted

Notes:
1 Actuator Code:
A: Handle tie pin spacer(s) and retainers provided unassembled with multi-pole units.
S: Handle moves to mid-position only upon electrical trip of the breaker. Available with circuit codes B, C, D, E, and H.
T: Handle moves to mid-position and alarm switch activates only upon electrical trip of the breaker. Available with circuit codes B & C.
2 Switch Only circuits, rated up to 50 amps and 6 poles, and only available when tied to a protected pole (Circuit Code B, C, D or H), For .01 to 30 amps, select Current Code 630. For 35 - 50 amps, select Current Code 650.
3 Available with terminal Codes 1, 2 and 3. Current Rating limited to 30 amps maximum. Consult factory for available Dual Coil options, as special catalog number is required. With Shunt construction, Dual Coils will trip instantaneously on line voltage. Dual coils require 30VA minimum power to trip and are rated for intermittent duty only.
5 On multi-pole breakers, one auxiliary switch is supplied, mounted in the extreme right pole.
6 Separate pole type voltage coils not rated for continuous duty. Available only with delay codes 10, 20 & 30.
7 Available with Circuit Codes B & D only. VDE Certified to 30 amps. UL Recognized, CSA Accepted & TUV Certified to 50 amps.
8 Available up to two poles with AC or DC delays.
9 Screw Terminals are recommended on ratings greater than 20 amps. Ratings over 30 amps are only available with Terminal Codes 5, 9, G and H.
10 Terminal Code 1: TUV Certification up to 30 amps, but not recommended over 20 amps.
11 Terminal Codes 3, 5, 7, 9, E, G and H (Bus Type) are supplied with Lock Washers. These breakers are only TUV Certified when the washers are used.
12 Single pole only.

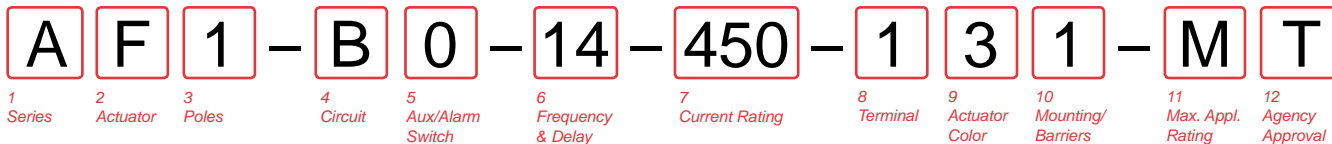

1 SERIES
A

2 ACTUATOR 1
Two Color Visi-Rocker
C Indicate ON, vertical legend
D Indicate ON, horizontal legend
F Indicate OFF, vertical legend
G Indicate OFF, horizontal legend
Single color
J Vertical legend
K Horizontal legend
Push-To-Reset, Visi-Rocker
N Indicate OFF, vertical legend
O Indicate OFF, horizontal legend
Push-To-Reset, Single color
R Vertical legend
U Horizontal legend

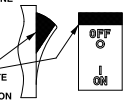
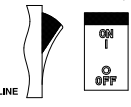
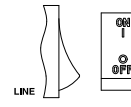
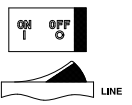
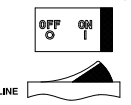
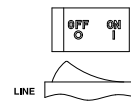
| ROCKER STYLE DESCRIPTIONS | | | |
|---------------------------|---|---|---|
| | INDICATE "ON" | INDICATE "OFF" | SINGLE COLOR |
| VERTICAL STYLE |  LINE CODE "C" INDICATE COLOR LOCATION |  LINE CODE "F", "N" |  LINE CODE "J", "R" |
| |  CODE "D" |  CODE "G", "O" |  LINE CODE "K", "U" |

3 POLES 2
1 One
2 Two
3 Three

4 CIRCUIT
B Series Trip (Current)

5 AUXILIARY / ALARM SWITCH 2
0 without Aux Switch
1 S.P.D.T., 0.093 Q.C. Term.
2 S.P.D.T., 0.110 Q.C. Term.
7 S.P.S.T., 0.110 Q.C. Term. (Gold Contacts)
8 S.P.S.T., 0.187 Q.C. Term.
9 S.P.D.T., 0.187 Q.C. Term.

6 FREQUENCY & DELAY
11 DC Ultra Short
12 DC Short
14 DC Medium
16 DC Long
52 DC, Short, Hi-Inrush
54 DC, Medium, Hi-Inrush
56 DC, Long, Hi-Inrush

7 CURRENT RATING (AMPERES)

| CODE | AMPERES | 285 | 0.850 | 455 | 5.500 | 613 | 13.000 |
|------|---------|-----|-------|-----|--------|-----|--------|
| 210 | 0.100 | 285 | 0.850 | 455 | 5.500 | 613 | 13.000 |
| 215 | 0.150 | 290 | 0.900 | 460 | 6.000 | 614 | 14.000 |
| 220 | 0.200 | 295 | 0.950 | 465 | 6.500 | 615 | 15.000 |
| 225 | 0.250 | 410 | 1.000 | 470 | 7.000 | 616 | 16.000 |
| 230 | 0.300 | 512 | 1.250 | 475 | 7.500 | 617 | 17.000 |
| 235 | 0.350 | 415 | 1.500 | 480 | 8.000 | 618 | 18.000 |
| 240 | 0.400 | 517 | 1.750 | 485 | 8.500 | 620 | 20.000 |
| 245 | 0.450 | 420 | 2.000 | 490 | 9.000 | 622 | 22.000 |
| 250 | 0.500 | 522 | 2.250 | 495 | 9.500 | 624 | 24.000 |
| 255 | 0.550 | 527 | 2.750 | 610 | 10.000 | 625 | 25.000 |
| 260 | 0.600 | 430 | 3.000 | 710 | 10.500 | 630 | 30.000 |
| 265 | 0.650 | 435 | 3.500 | 611 | 11.000 | 635 | 35.000 |
| 270 | 0.700 | 440 | 4.000 | 711 | 11.500 | 640 | 40.000 |
| 275 | 0.750 | 445 | 4.500 | 612 | 12.000 | 645 | 45.000 |
| 280 | 0.800 | 450 | 5.000 | 712 | 12.500 | 650 | 50.000 |

8 TERMINAL 5
1 Push-On 0.250 Tab (Q.C.)
2 Screw 8-32 with upturned lugs
3 Screw 8-32 (Bus Type)
4 Screw 10-32 with upturned lugs
5 Screw 10-32 (Bus Type)
6 Screw 8-32 with upturned lugs & 30° bend
7 Screw 8-32 (Bus Type)
8 Screw 10-32 with upturned lugs & 30° bend
9 Screw 10-32 (Bus Type) & 30° bend
B Screw M5 with upturned lugs
F Screw M5 with upturned lugs & 30° bend
G Screw M5 (Bus Type) & 30° bend
H Screw M5 (Bus Type)
M M6 Threaded Stud
P Printed Circuit Board Terminals
Q Push-In Stud

9 ACTUATOR COLOR & LEGEND

| Actuator or Visi-Color 10 | Marking: | | Marking Color | |
|---------------------------|----------|---------|---------------|-------------|
| | ON-OFF | Dual 10 | Single Color | Visi-Rocker |
| White | B | 1 | Black | White |
| Black | D | 2 | White | n/a |
| Red | G | 3 | White | Red |
| Green | J | 4 | White | Green |
| Blue | L | 5 | White | Blue |
| Yellow | N | 6 | Black | Yellow |
| Gray | Q | 7 | Black | Gray |
| Orange | S | 8 | Black | Orange |

10 MOUNTING / BARRIERS 11
STANDARD ROCKER BEZEL
Threaded Insert, 2 per pole
1 6-32 x 0.195 inches
A 6-32 X 0.195 inches (multi-pole units only)
2 ISO M3 x 5mm
B ISO M3 x 5mm (multi-pole units only)
ROCKERGUARD & PUSH-TO-RESET BEZEL
Threaded Insert, 2 per pole
3 6-32 x 0.195 inches
C 6-32 x 0.195 inches (multi-pole units only)
4 ISO M3 x 5mm
D ISO M3 x 5mm (multi-pole units only)
FRONT PANEL SNAP-IN BRACKET, 0.744" [18.90mm] wide bezel
8 without Rockerguard (single pole units only)
H with Rockerguard (single pole units only)
FRONT PANEL SNAP-IN BRACKET, 0.96" [24.48mm] wide bezel
9 without Rockerguard (single pole units only)
J with Rockerguard (single pole units only)

11 MAXIMUM APPLICATION RATING
M 80 DC

12 AGENCY APPROVAL
T UL489A Listed
K UL489A Listed, VDE Certified
J UL489A Listed, TUV Certified

- Notes:
- 1 Push-To-Reset actuators have OFF portion of rocker shrouded.
 - 2 Multi-pole breakers have all breakers identical except when specifying Auxiliary switch and/or mixed poles, and have one rocker per breaker.
 - 3 Auxiliary Switch breakers with Series Trip circuits: ≤ 30A, are supplied with standard half shells. 30-50A are supplied with extended boat (B-Style) half shells.
 - 4 VDE Certification available with single pole breakers only. UL489A Listing available with one and two pole breakers.
 - 5 Screw Terminals are recommended on ratings greater than 20 amps. Ratings over 30 amps are only available with Terminal Codes 5, 9, G, H, M and Q.
 - 6 Terminal Code 1 (Push-On) available up to 25 amps with TUV or VDE Certification and 30 amps with UL489A Listing, but is not recommended over 20 amps.
 - 7 Terminal Codes 3, 5 and H (Bus Type) with TUV or VDE, are supplied with Lock Washers, and Terminal Code M (M6 Threaded Stud) with VDE is supplied with Lock and Flat Washers. These breakers are only TUV or VDE Certified when the washers are used.
 - 8 Single pole breakers with Terminal Code P (Printed Circuit Board) are available up to 30 amps with VDE Certification and 50 amps with UL489A Listing.
 - 9 Terminal Code Q not available with VDE certification.
 - 10 Color shown is Visi and Legend with remainder of rocker black. Dual = ON-OFF/I-O legend.
 - 11 Legend on Push-to-reset bezel/shroud is white with single color actuator codes R & U. Legend on Push-To-Reset bezel/shroud matches Visi-Color of rocker with actuator codes N & O. Rockerguard available with actuator codes C through K

Circuit & Terminal Diagrams: in. [mm]

| CIRCUIT BREAKER PROFILE | CIRCUIT SCHEMATIC | | CIRCUIT SCHEMATIC | | | |
|-------------------------|--|--------------|-------------------|---|----|------------------|
| | ANSI | CIRCUIT CODE | ANSI | CIRCUIT CODE | | |
| 2 TERMINALS | SWITCH ONLY (NO COIL) | A | 0 | SERIES TRIP | BC | 0 |
| 5 TERMINALS | SWITCH ONLY (NO COIL) WITH AUXILIARY SWITCH | A | 1 2 3 4 | SERIES TRIP WITH (3) AUXILIARY/ALARM SWITCH | BC | 1 2 3 4 |
| 3 TERMINALS | SHUNT TRIP | DE | 0 | DUAL COIL; SERIES TRIP CURRENT COIL, SHUNT TRIP VOLTAGE COIL | H | 0 |
| 4 TERMINALS | RELAY TRIP | FG | 0 | DUAL COIL; SERIES TRIP CURRENT COIL, RELAY TRIP VOLTAGE COIL | K | 0 |

AUXILIARY/ALARM SWITCH TERMINAL DETAIL

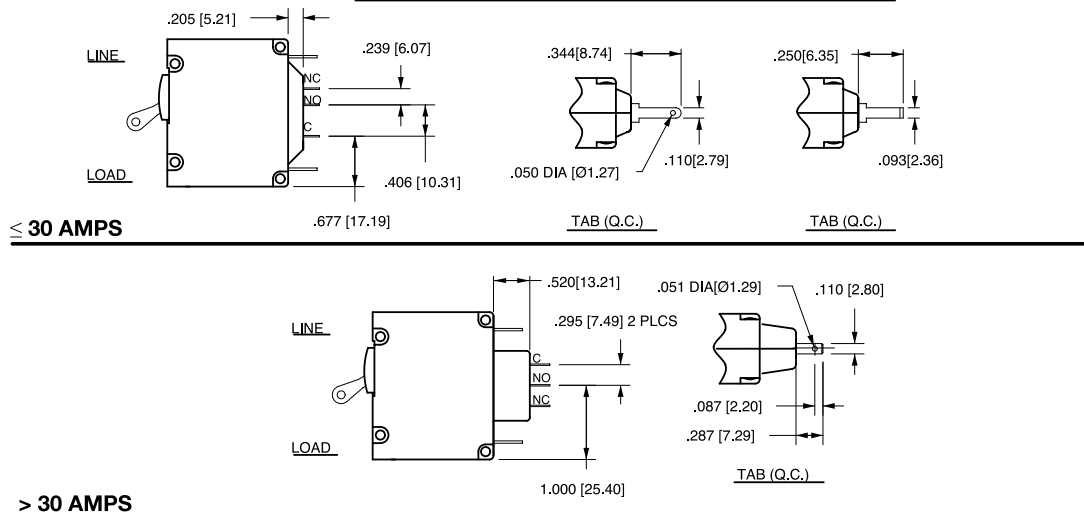

- Notes:
- All dimensions are in inches [millimeters].
 - Tolerance $\pm .020$ [.51] unless otherwise specified.
 - Alarm Switch available with .110 x .020 Q.C. & Solder Lug Terminals Only.

Circuit & Terminal Diagrams: in. [mm]

| HANDLE POSITION VS. AUX/ALARM SWITCH MODE | | | | | | |
|---|-----------------|------------------|-----------------|-------------------|-----------------|-------------------------------------|
| CIRCUIT BREAKER MODE | STANDARD C/B | | MID TRIP C/B | | MID TRIP C/B | |
| | HANDLE POSITION | AUX. SWITCH MODE | HANDLE POSITION | ALARM SWITCH MODE | HANDLE POSITION | AUX. SWITCH MODE (w/o ALARM SWITCH) |
| OFF | | | | | | |
| ON | | | | | | |
| ELECTRICAL TRIP | | | | | | |

| TERMINAL DIMENSIONAL DETAIL & RATING | | | | | | |
|--------------------------------------|---|--------------------------------------|-------------------------|-------------------------------|-------------------|------------------------|
| | | | | | | |
| TAB (Q.C.) 30 AMP | UPTURN LUG #8-32 30 AMP #10-32 30 AMP M5 30 AMP M4 30 AMP | BUS #8-32 30 AMP #10-32 50 AMP | QC SOLDER LUG 30 AMP | .110 QC VOLTAGE COILS ONLY | M6 STUD 50 AMP | PUSH-IN STUD 50 AMP |

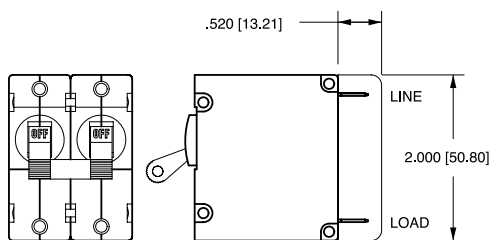
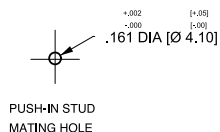

BARRIER FOR UL-RECOGNIZED MULTI-POLE BREAKERS

| TABLE A TIGHTENING TORQUE SPECIFICATIONS | |
|---|---------------------------|
| THREAD SIZE | TORQUE |
| #6-32 & M3 MOUNTING HARDWARE | 7-9 IN-LBS [0.8-1.0 NM] |
| #8-32 & M4 THREAD TERMINAL SCREW | 12-15 IN-LBS [1.4-1.7 NM] |
| #10-32 & M5 THREAD TERMINAL SCREW | 15-20 IN-LBS [1.7-2.3 NM] |

| TABLE B | | |
|--------------------------|-----------------------------|--------------------|
| TERMINAL DESCRIPTION | | DEPTH BEHIND PANEL |
| MAIN | TAB (Q.C.) | 2.000 [50.80] |
| | SCREW TYPE | 2.032 [51.60] |
| SHUNT, RELAY & DUAL COIL | TAB (Q.C.) | 2.207 [56.10] |
| | SCREW #8-32 W/UPTURNED LUGS | 2.364 [60.05] |
| AUX. SWITCH* | .093 TAB (Q.C.) | 2.095 [53.20] |
| | .110 TAB (Q.C.) | 2.189 [55.60] |
| | SOLDER TYPE | 1.970 [50.00] |

* AVAILABLE ON SERIES TRIP AND SWITCH ONLY CIRCUITS. WHEN CALLED FOR ON MULTI-POLE UNITS, ONLY ONE AUX. SWITCH IS NORMALLY SUPPLIED, AS SHOWN IN MULTI-POLE IDENTIFICATION SCHEME.

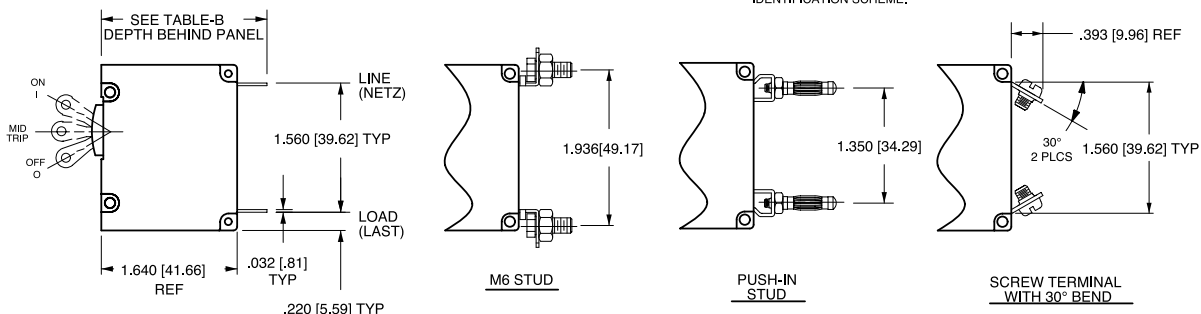

- Notes:
- All dimensions are in inches [millimeters].
 - Tolerance ± 0.02 [51] unless otherwise specified.
 - Alarm Switch available with .110 x .020 QC & solder lug terminals only.

Dimensional Specifications: in. [mm]

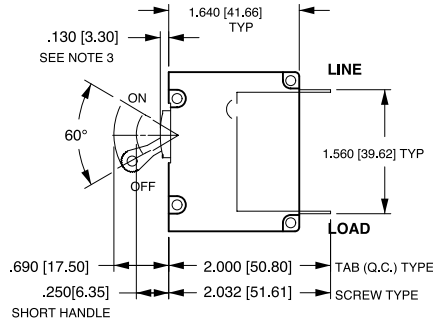
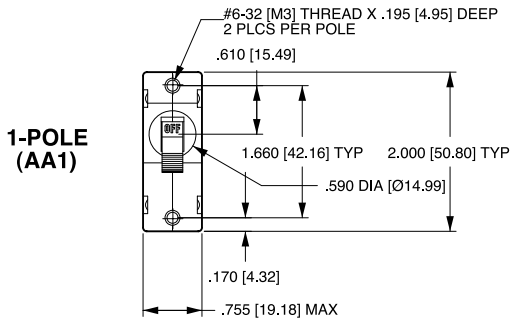

TAB (Q.C.) TYPE TERMINALS IN SERIES TRIP CIRCUIT CONFIGURATION SHOWN. FOR OTHER CONFIGURATIONS, SEE CIRCUIT AND TERMINAL DIAGRAMS.

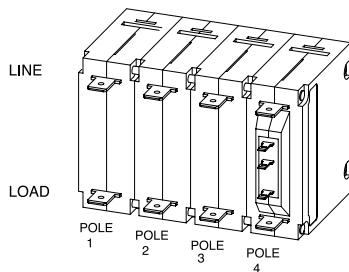
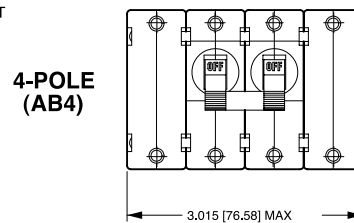
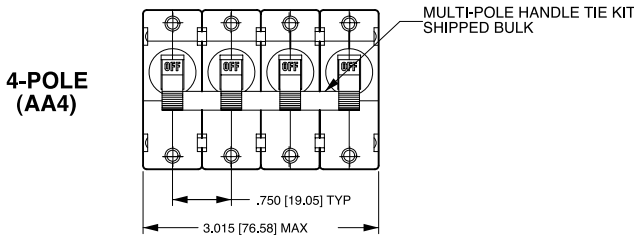
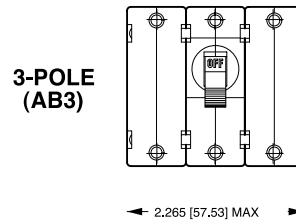
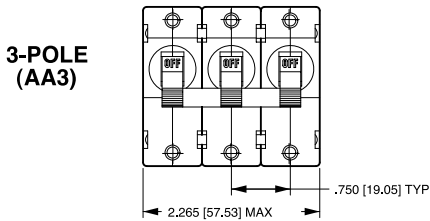
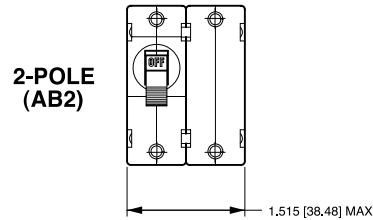
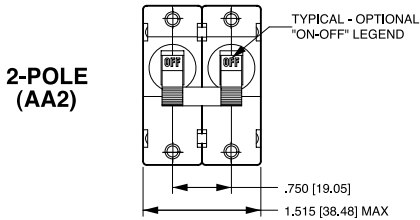

MULTI-POLE IDENTIFICATION SCHEME AS VIEWED FROM TERMINAL END OF BREAKER.

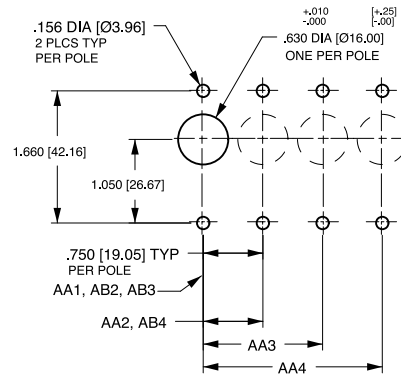

TOLERANCES ±.005 [±.12] UNLESS OTHERWISE SPECIFIED

Notes:

- 1 All dimensions are in inches [millimeters].
- 2 Tolerance ± 0.20 [.51] unless otherwise specified.
- 3 For agency code P = .150 [3.81].

Dimensional Specifications: in. [mm]

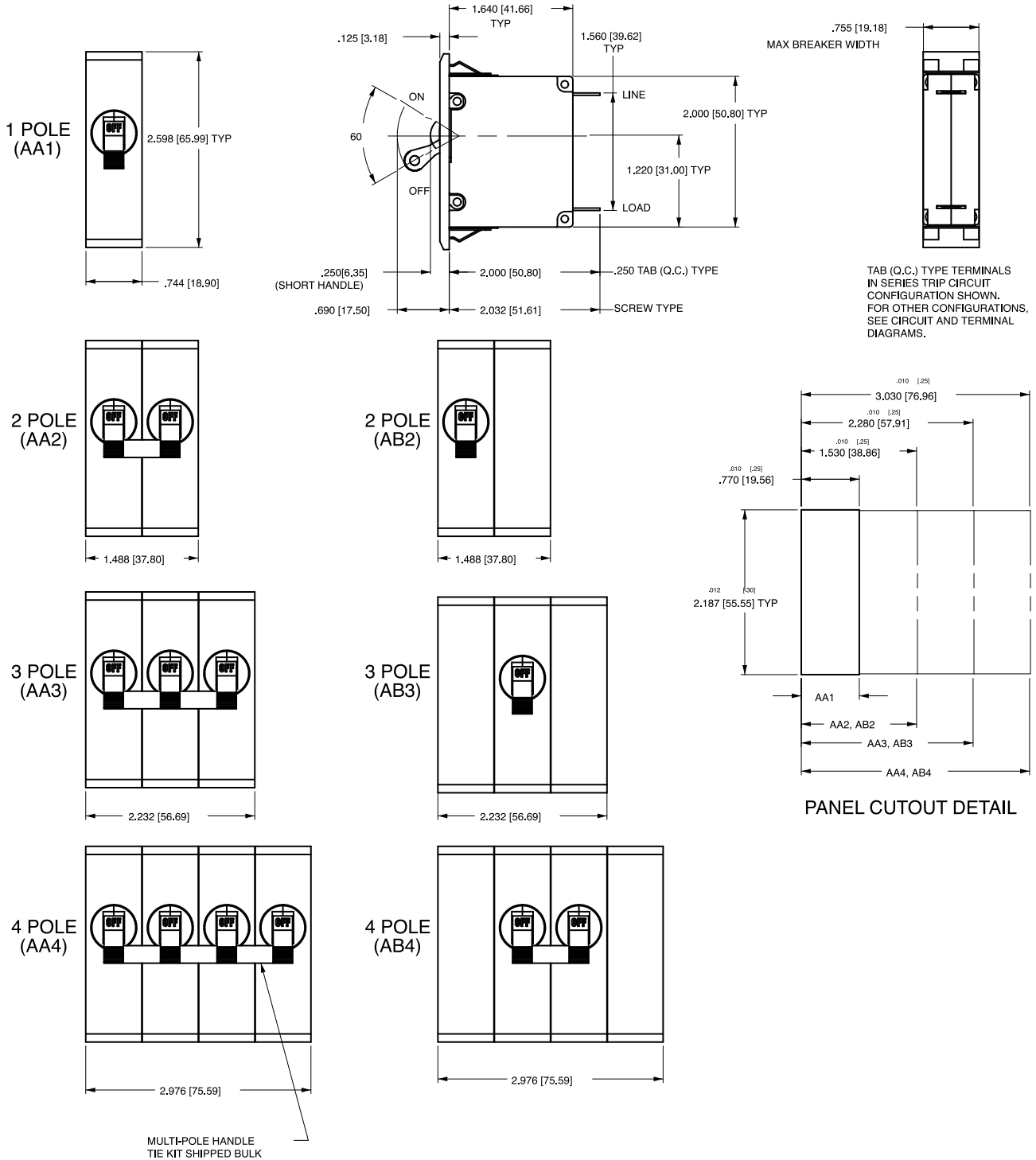

- Notes:
- 1 All dimensions are in inches [millimeters].
 - 2 Recommended panel thickness: .040 [1.02] to .100 [2.54].
 - 3 Tolerance $\pm .020$ [.51] unless otherwise specified.

Dimensional Specifications: in. [mm]

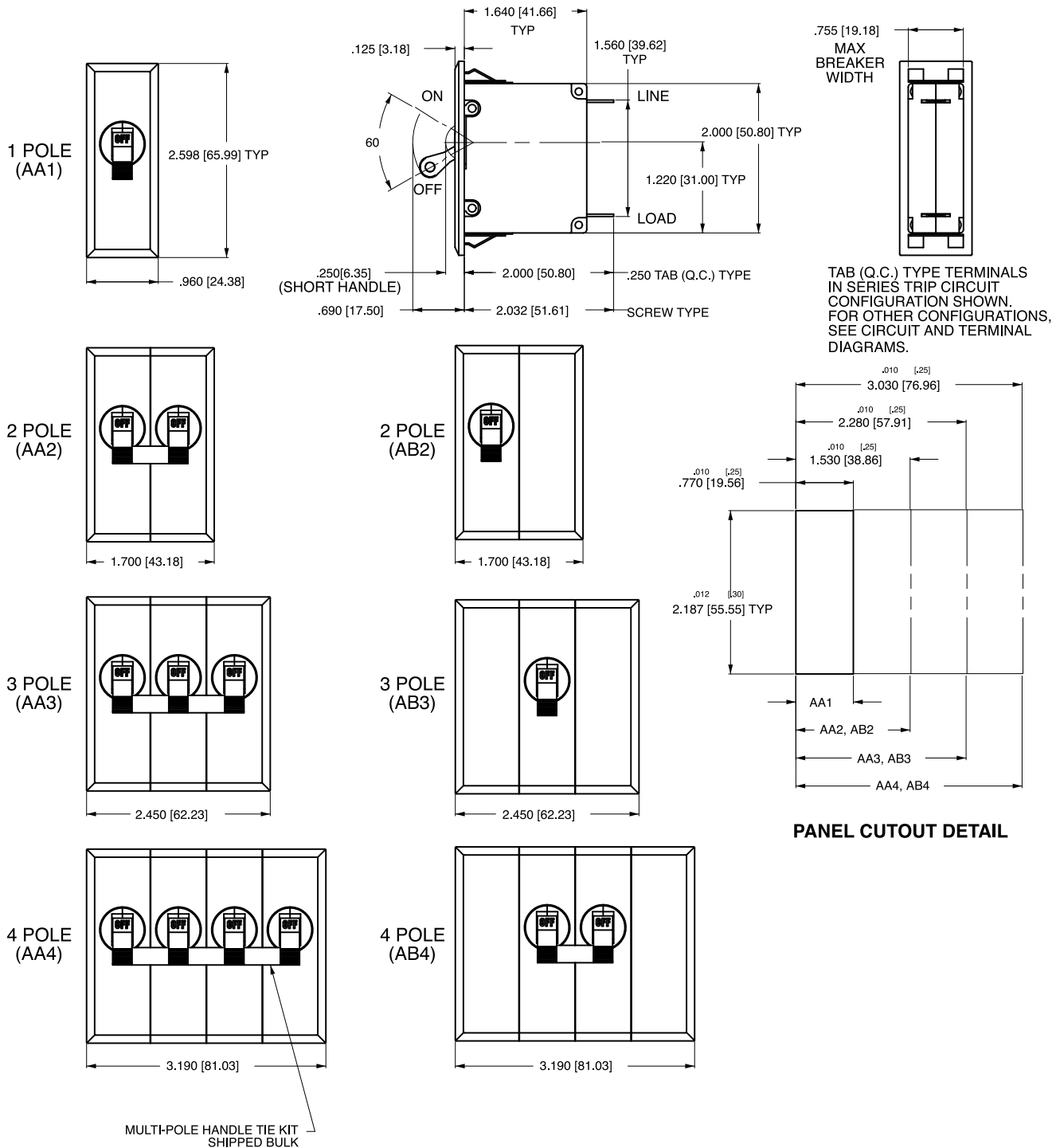

- Notes:
- 1 All dimensions are in inches [millimeters].
 - 2 Recommended panel thickness: .040 [1.02] to .100 [2.54].
 - 3 Tolerance ± 0.020 [.51] unless otherwise specified.

A M 1 - B 0 - 10 - 450 - 1 0 1 - C

1 Series 2 Actuator 3 Poles 4 Circuit 5 Aux/Alarm Switch 6 Frequency & Delay 7 Current Rating 8 Terminal 9 Actuator Color 10 Mounting/Barriers 11 Agency Approval

1 SERIES
A

2 ACTUATOR ¹

M Sealed Toggle, one per unit

3 POLES

1 One
2 Two
3 Three

4 CIRCUIT

| | |
|--------------------------------------|---|
| A ² Switch Only (No Coil) | F ³ Relay Trip (Current) |
| B Series Trip (Current) | G ³ Relay Trip (Voltage) |
| C Series Trip (Voltage) | H ^{3,4} Dual Coil with Shunt Trip Voltage Coil |
| D ³ Shunt Trip (Current) | K ^{3,4} Dual Coil with Relay Trip Voltage Coil |
| E ³ Shunt Trip (Voltage) | |

5 AUXILIARY / ALARM SWITCH ⁵

| | |
|--|--|
| 0 without Aux Switch | 5 S.P.S.T., 0.093 Q.C. Term. (Gold Contacts) |
| 1 S.P.D.T., 0.093 Q.C. Term. | 7 S.P.S.T., 0.110 Q.C. Term. (Gold Contacts) |
| 2 S.P.D.T., 0.110 Q.C. Term. | 8 S.P.S.T., 0.187 Q.C. Term. |
| 4 S.P.D.T., 0.110 Q.C. Term. (Gold Contacts) | 9 S.P.D.T., 0.187 Q.C. Term. |

6 FREQUENCY & DELAY

| | |
|----------------------------|---|
| 03 DC 50/60Hz, Switch Only | 30 DC, 50/60Hz Instantaneous |
| 10 DC Instantaneous | 31 DC, 50/60Hz Ultra Short |
| 11 DC Ultra Short | 32 DC, 50/60Hz Short |
| 12 DC Short | 34 DC, 50/60Hz Medium |
| 14 DC Medium | 36 DC, 50/60Hz Long |
| 16 DC Long | 42 ⁷ 50/60Hz Short, Hi-Inrush |
| 20 50/60Hz Instantaneous | 44 ⁷ 50/60Hz Medium, Hi-Inrush |
| 21 50/60Hz Ultra Short | 46 ⁷ 50/60Hz Long, Hi-Inrush |
| 22 50/60Hz Short | 52 ⁷ DC, Short, Hi-Inrush |
| 24 50/60Hz Medium | 54 ⁷ DC, Medium, Hi-Inrush |
| 26 50/60Hz Long | 56 ⁷ DC, Long, Hi-Inrush |

7 CURRENT RATING (AMPERES)

| CODE | AMPERES | | | | |
|------|---------|-----|-------|-----|--------|
| 020 | 0.020 | 230 | 0.300 | 425 | 2.500 |
| 025 | 0.025 | 235 | 0.350 | 527 | 2.750 |
| 030 | 0.030 | 240 | 0.400 | 430 | 3.000 |
| 035 | 0.035 | 245 | 0.450 | 435 | 3.500 |
| 040 | 0.040 | 250 | 0.500 | 440 | 4.000 |
| 045 | 0.045 | 255 | 0.550 | 445 | 4.500 |
| 050 | 0.050 | 260 | 0.600 | 450 | 5.000 |
| 055 | 0.055 | 265 | 0.650 | 455 | 5.500 |
| 060 | 0.060 | 270 | 0.700 | 460 | 6.000 |
| 065 | 0.065 | 275 | 0.750 | 465 | 6.500 |
| 070 | 0.070 | 280 | 0.800 | 470 | 7.000 |
| 075 | 0.075 | 285 | 0.850 | 475 | 7.500 |
| 080 | 0.080 | 290 | 0.900 | 480 | 8.000 |
| 085 | 0.085 | 295 | 0.950 | 485 | 8.500 |
| 090 | 0.090 | 410 | 1.000 | 490 | 9.000 |
| 095 | 0.095 | 512 | 1.250 | 495 | 9.500 |
| 210 | 0.100 | 415 | 1.500 | 610 | 10.000 |
| 215 | 0.150 | 517 | 1.750 | 710 | 10.500 |
| 220 | 0.200 | 420 | 2.000 | 611 | 11.000 |
| 225 | 0.250 | 522 | 2.250 | 711 | 11.500 |

OR VOLTAGE COIL (NORMAL RATED VOLTAGE) ⁶

| CODE | AMPERES | | | | |
|------|---------|-----|-------|-----|--------|
| A06 | 6 DC | A32 | 32 DC | J12 | 12 AC |
| A12 | 12 DC | A48 | 48 DC | J18 | 18 AC |
| A18 | 18 DC | A65 | 65 DC | J24 | 24 AC |
| A24 | 24 DC | J06 | 6 AC | J48 | 48 AC |
| | | | | J65 | 65 AC |
| | | | | K20 | 120 AC |
| | | | | L40 | 240 AC |

8 TERMINAL ⁹

| | |
|---|---|
| 1 ¹⁰ Push-On 0.250 Tab (Q.C.) | E Screw M4 (Bus Type) |
| 2 Screw 8-32 with upturned lugs | F Screw M5 with upturned lugs & 30° bend |
| 3 Screw 8-32 (Bus Type) | G Screw M5 (Bus Type) & 30° bend |
| 4 Screw 10-32 with upturned lugs | H Screw M5 (Bus Type) |
| 5 Screw 10-32 (Bus Type) | L ¹² 0.250 Q.C./ Solder Lug |
| 6 Screw 8-32 with upturned lugs & 30° bend | M M6 Threaded Stud |
| 7 Screw 8-32 (Bus Type) & 30° bend | Q Push-In Stud |
| 8 Screw 10-32 with upturned lugs & 30° bend | R Screw M4 with upturned lugs & 30° bend |
| 9 Screw 10-32 (Bus Type) & 30° bend | T Screw M4 (Bus Type) & 30° bend |
| B Screw M5 with upturned lugs | P ¹² Printed Circuit Board Terminals |
| C Screw M4 with upturned lugs | S Push-On 0.110 Tab (Q.C.) |

9 LEGEND PLATE

0 No legend plate

10 MOUNTING / BARRIERS

| MOUNTING STYLE | BARRIERS |
|-------------------------------------|----------|
| 1 Standard Hex Nut | no |
| A Standard Hex Nut (multipole only) | yes |

11 AGENCY APPROVAL

C UL Recognized & CSA Accepted
I UL Recognized STD 1077, UL Recognized 1500 (ignition protected), & CSA Accepted

Notes:

- Actuator Code M: Handle location as viewed from front of panel:
2 pole - right pole 3 pole - center pole
- Switch Only circuits, rated up to 50 amps and 3 poles. Only available when tied to a protected pole. For .02 to 30 amps, select Current Code 630. For 35 - 50 amps, select Current Code 650.
- Available with terminal Codes 1, 2 and 3. Current Rating limited to 30 amps maximum.
- Consult factory for available Dual Coil options, as special catalog number is required. With Shunt construction, Dual Coils will trip instantaneously on line voltage. Dual coils require 30VA minimum power to trip and are rated for intermittent duty only.
- Auxiliary Switch available on Series Trip & Switch Only circuits, limited to 30 amps. On multi-pole breakers, one auxiliary switch is supplied, mounted in the extreme right pole.
- Voltage coils not rated for continuous duty. Available only with delay codes 10 and 20.
- Available with Circuit Codes B & D only. VDE Certified to 30 amps. UL Recognized, CSA Accepted & TUV Certified to 50 amps.
- UL Recognition and CSA Certification available on one and two pole breakers.
- Screw Terminals are recommended on ratings greater than 20 amps. Ratings over 30 amps are only available with Terminal Codes 5, 9, B, F, G, H, M and Q.
- Terminal Code 1: UL Recognition and CSA Certification up to 30 amps, but not recommended over 20 amps.
- Terminal Code L: available up to 30A.
- Single pole breakers with Terminal Code P (Printed Circuit Board) are available up to 50 amps, with Circuit Codes A, B and C. Two pole breakers with Terminal Code P (Printed Circuit Board) are available up to 40 amps with Circuit Codes A, B and C.

Dimensional Specifications: in. [mm]

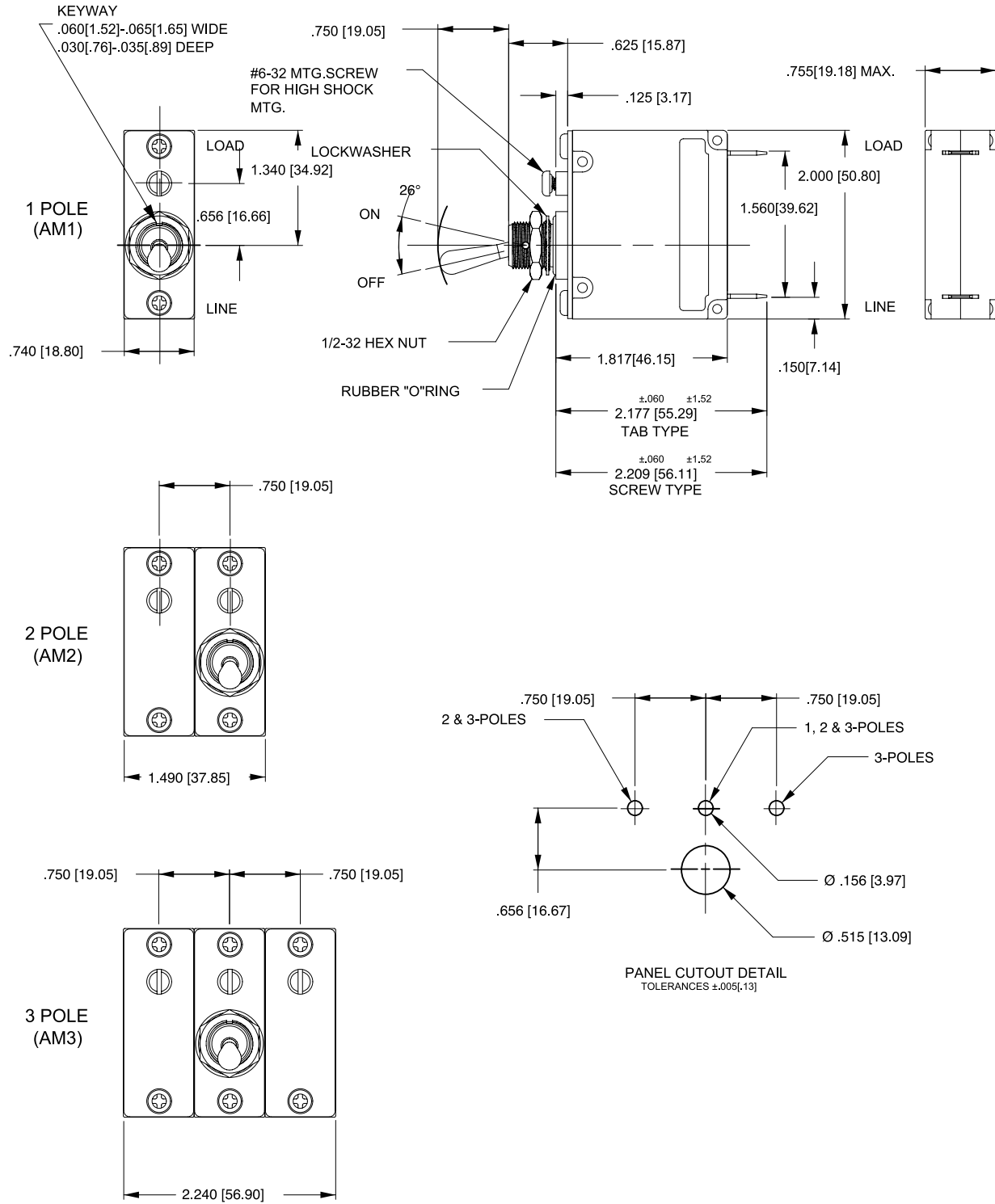

Notes:

- 1 All dimensions are in inches [millimeters].
- 2 Tolerance ±.020 [.51] unless otherwise specified.

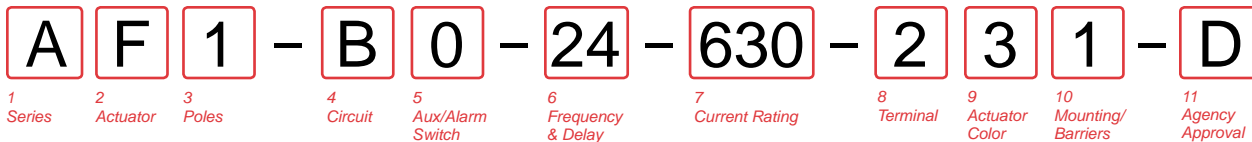

1 SERIES

A

2 ACTUATOR 1

Two Color Visi-Rocker

- C Indicate ON, vertical legend
- D Indicate ON, horizontal legend
- F Indicate OFF, vertical legend
- G Indicate OFF, horizontal legend
- H Indicate OFF, no legend

Push-To-Reset, Visi-Rocker

- N Indicate OFF, vertical legend
- O Indicate OFF, horizontal legend
- P Indicate OFF, no legend

Single color

- J Vertical legend
- K Horizontal legend
- L No legend

Push-To-Reset, Single color

- R Vertical legend
- U Horizontal legend
- V No legend

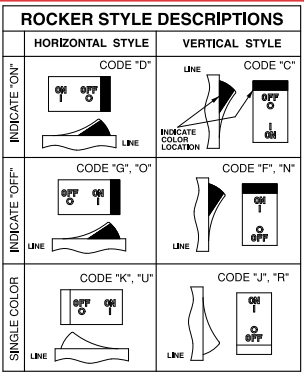

3 POLES

- 1 One
- 2 Two
- 3 Three

4 CIRCUIT

- A³ Switch Only (No Coil)
- B Series Trip (Current)
- C Series Trip (Voltage)
- D⁴ Shunt Trip (Current)
- E⁴ Shunt Trip (Voltage)
- F⁴ Relay Trip (Current)
- G⁴ Relay Trip (Voltage)
- H^{4,5} Dual Coil with Shunt Trip Voltage Coil
- K^{4,5} Dual Coil with Relay Trip Voltage Coil

5 AUXILIARY / ALARM SWITCH 6,7

- 0 without Aux Switch
- 1 S.P.D.T., 0.093 Q.C. Term.
- 2 S.P.D.T., 0.110 Q.C. Term.
- 4 S.P.D.T., 0.110 Q.C. Term. (Gold Contacts)
- 5 S.P.S.T., 0.093 Q.C. Term. (Gold Contacts)
- 7 S.P.S.T., 0.110 Q.C. Term. (Gold Contacts)
- 8 S.P.S.T., 0.187 Q.C. Term.
- 9 S.P.D.T., 0.187 Q.C. Term.

6 FREQUENCY & DELAY

- 03 DC 50/60Hz, Switch Only
- 10 DC Instantaneous
- 11 DC Ultra Short
- 12 DC Short
- 14 DC Medium
- 16 DC Long
- 20 50/60Hz Instantaneous
- 21 50/60Hz Ultra Short
- 22 50/60Hz Short
- 24 50/60Hz Medium
- 26 50/60Hz Long
- 30 DC, 50/60Hz Instantaneous
- 31 DC, 50/60Hz Ultra Short
- 32 DC, 50/60Hz Short
- 34 DC, 50/60Hz Medium
- 36 DC, 50/60Hz Long
- 42⁹ 50/60Hz Short, Hi-Inrush
- 44⁹ 50/60Hz Medium, Hi-Inrush
- 46⁹ 50/60Hz Long, Hi-Inrush
- 52⁹ DC, Short, Hi-Inrush
- 54⁹ DC, Medium, Hi-Inrush
- 56⁹ DC, Long, Hi-Inrush

Notes:

- 1 Push-To-Reset actuators have OFF portion of rocker shrouded.
- 2 Multi-pole breakers have all breakers identical except when specifying Auxiliary switch and/or mixed poles, and have one rocker per breaker.
- 3 Switch Only circuits, rated up to 50 amps & 3 poles, are available only when tied to a protected pole (Circuit Code B, C, D or H). For .02 to 30 amps, select Current Code 630. For 35 - 50 amps, select Current Code 650.
- 4 Available with terminal Codes 1, 2 and 3. Current Rating limited to 30 amps maximum.
- 5 Consult factory for Dual Coil options, as special catalog number is required. With Shunt construction, Dual Coils will trip instantaneously on line voltage. Dual coils require 30VA minimum power to trip and are rated for intermittent duty only.
- 6 Auxiliary Switch breakers with Series Trip & Switch Only circuits: ≤ 30A, are supplied with standard half shells. 30-50A are supplied with extended boat (B-Style) half shells.
- 7 On multi-pole breakers, one auxiliary switch is supplied, mounted in the extreme right pole.
- 8 Separate pole type voltage coils not rated for continuous duty. Available only with delay codes 10 & 20.
- 9 Available with Circuit Codes B & D only. VDE Certified to 30 amps. UL Recognized, CSA Accepted & TUV Certified to 50 amps.
- 10 Series Trip current ratings: VDE Certification available with single pole breakers with DC Delay only. UL Recognition & CSA Accepted available in one and two pole breakers.
- 11 Screw Terminals are recommended on ratings greater than 20 amps. Ratings over 30 amps are only available with Terminal Codes 5, 9, G, H, M and Q.
- 12 Terminal Code 1: VDE Certification up to 25 amps and UL Recognition and CSA Accepted up to 30 amps, but not recommended over 20 amps.
- 13 Terminal Codes 3, 5 E & H (Bus Type) with VDE, are supplied with Lock Washers; Terminal Code M (M6 Threaded Stud) with VDE is supplied with Lock and Flat Washers. These breakers are only VDE Certified when the washers are used.
- 14 VDE Cert. available up to 12 amps. UL Rec. & CSA Accepted available up to 30 amps.
- 15 Single pole breakers with Terminal Code P (Printed Circuit Board) are available up to 30 amps with VDE Certification and 50 amps with UL Recognition and CSA Accepted, with Circuit Codes A, B & C. Two pole breakers with Terminal Code P (Printed Circuit Board) are available up to 40 amps with UL Recognition and CSA Certification with Circuit Codes A, B and C.
- 16 Terminal Code Q not available with VDE.
- 17 Terminal Code S used on voltage coil circuit constructions only.
- 18 Color shown is visi and legend with remainder of rocker black.
- 19 Dual = ON-OFF/I-O legend with actuator. None = no legend on actuator
- 20 Legend on Push-to-reset bezel/shroud is white with single color actuator codes R, & U. Legend on Push-to-reset bezel/shroud matches Visi-color of rocker with actuator codes N & O. Rockerguard available with actuator codes C through L.

7 CURRENT RATING (AMPERES)

| CODE | AMPERES | 225 | 230 | 240 | 245 | 250 | 255 | 260 | 265 | 270 | 275 | 280 | 285 | 290 | 295 | 410 | 512 | 515 | 517 | 420 | 430 | 435 | 440 | 445 | 450 | 455 | 460 | 465 | 470 | 475 | 480 | 485 | 490 | 495 | 610 | 611 | 612 | 613 | 614 | 615 | 616 | 617 | 618 | 620 | 622 | 624 | 625 | 630 | 635 ⁸ | 640 ⁸ | 645 ⁸ | 650 ⁸ | | | | | | | |
|------|---------|-------|-------|-------|-------|-------|-------|-------|-------|-------|-------|-------|-------|-------|-------|-------|-------|-------|-------|-------|-------|-------|-------|-------|-------|-------|-------|-------|-------|-------|-------|-------|-------|-------|-------|-------|-------|--------|--------|--------|--------|--------|--------|--------|--------|--------|--------|--------|------------------|------------------|------------------|------------------|--------|--------|--------|--------|--------|--------|--------|
| 020 | 0.020 | 0.250 | 0.300 | 0.400 | 0.450 | 0.500 | 0.550 | 0.600 | 0.650 | 0.700 | 0.750 | 0.800 | 0.850 | 0.900 | 0.950 | 1.000 | 1.250 | 1.500 | 1.750 | 2.000 | 2.250 | 2.500 | 2.750 | 3.000 | 3.500 | 4.000 | 4.500 | 5.000 | 5.500 | 6.000 | 6.500 | 7.000 | 7.500 | 8.000 | 8.500 | 9.000 | 9.500 | 10.000 | 10.500 | 11.000 | 11.500 | 12.000 | 12.500 | 13.000 | 13.500 | 14.000 | 15.000 | 16.000 | 17.000 | 18.000 | 20.000 | 22.000 | 24.000 | 25.000 | 30.000 | 35.000 | 40.000 | 45.000 | 50.000 |

OR VOLTAGE COIL (NORMAL RATED VOLTAGE)⁸

| CODE | AMPERES | A06 | A12 | A18 | A24 | A32 | A48 | A65 | J06 | J12 | J18 | J24 | J48 | K65 | L40 |
|------|---------|------|-------|-------|-------|-------|-------|-------|------|-------|-------|-------|-------|-------|--------|
| | | 6 DC | 12 DC | 18 DC | 24 DC | 32 DC | 48 DC | 65 DC | 6 AC | 12 AC | 18 AC | 24 AC | 48 AC | 65 AC | 120 AC |

8 TERMINAL¹¹

- 1¹² Push-On 0.250 Tab (Q.C.)
- 2 Screw 8-32 with upturned lugs
- 3¹³ Screw 8-32 (Bus Type)
- 4 Screw 10-32 with upturned lugs
- 5¹³ Screw 10-32 (Bus Type)
- 6 Screw 8-32 with upturned lugs & 30° bend
- 7 Screw 8-32 (Bus Type) & 30° bend
- 8 Screw 10-32 with upturned lugs & 30° bend
- 9 Screw 10-32 (Bus Type) & 30° bend
- B Screw M5 with upturned lugs
- C Screw M4 with upturned lugs
- E¹³ Screw M4 (Bus Type)
- F Screw M5 with upturned lugs & 30° bend
- G Screw M5 (Bus Type) & 30° bend
- H¹³ Screw M5 (Bus Type)
- L¹⁴ 0.250 Q.C./ Solder Lug
- M¹³ M6 Threaded Stud
- P¹⁵ Printed Circuit Board Terminals
- Q¹⁶ Push-In Stud
- R Screw M4 with upturned lugs & 30° bend
- S¹⁷ Push-On 0.110 Tab (Q.C.) & 30° bend
- T Screw M4 (Bus Type) & 30° bend

9 ACTUATOR COLOR & LEGEND

| Actuator or Visi-Color ¹² | Marking: | | Marking Color | |
|--------------------------------------|----------|--------------------|---------------|-------------|
| | ON-OFF | Dual ¹² | Single Color | Visi-Rocker |
| White | B | 1 | Black | White |
| Black | D | 2 | White | n/a |
| Red | G | 3 | White | Red |
| Green | J | 4 | White | Green |
| Blue | L | 5 | White | Blue |
| Yellow | N | 6 | Black | Yellow |
| Gray | Q | 7 | Black | Gray |
| Orange | S | 8 | Black | Orange |

10 MOUNTING / BARRIERS²⁰

| | STANDARD ROCKER BEZEL | BARRIERS |
|---|---|----------|
| | Threaded Insert, 2 per pole | |
| 1 | 6-32 x 0.195 inches | no |
| A | 6-32 X 0.195 inches (multi-pole units only) | yes |
| 2 | ISO M3 x 5mm | no |
| B | ISO M3 x 5mm (multi-pole units only) | yes |
| | ROCKERGUARD & PUSH-TO-RESET BEZEL | |
| | Threaded Insert, 2 per pole | |
| 3 | 6-32 x 0.195 inches | no |
| C | 6-32 x 0.195 inches (multi-pole units only) | yes |
| 4 | ISO M3 x 5mm | no |
| D | ISO M3 x 5mm (multi-pole units only) | yes |
| | FRONT PANEL SNAP-IN BRACKET, 0.744" [18.90mm] wide bezel | |
| 8 | without Rockerguard (single pole units only) | no |
| H | with Rockerguard (single pole units only) | no |
| | FRONT PANEL SNAP-IN BRACKET, 0.96" [24.48mm] wide bezel | |
| 9 | without Rockerguard (single pole units only) | no |
| J | with Rockerguard (single pole units only) | no |

11 AGENCY APPROVAL

- C UL Recognized & CSA Accepted
- D VDE Certified, UL Recognized & CSA Accepted
- E TUV Certified, UL Recognized & CSA Accepted
- I UL Recognized STD 1077, UL Recognized 1500 (ignition protected), & CSA Accepted

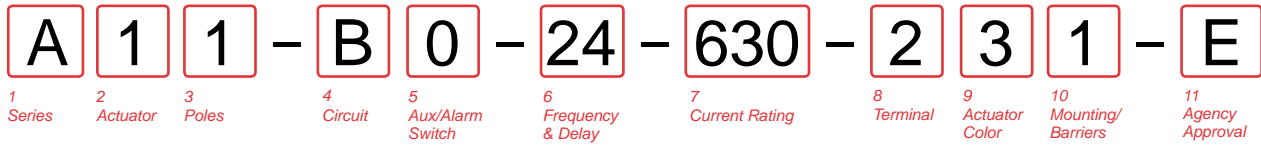

1 SERIES
A

2 ACTUATOR 1

- Two Color Visi-Rocker**
- 1 Indicate OFF, vertical legend
- 2 Indicate OFF, horizontal legend
- Single color**
- 3 Vertical legend
- 4 Horizontal legend
- Push-To-Reset, Visi-Rocker**
- 5 Indicate OFF, vertical legend
- 6 Indicate OFF, horizontal legend
- Push-To-Reset, Single color**
- 7 Vertical legend
- 8 Horizontal legend

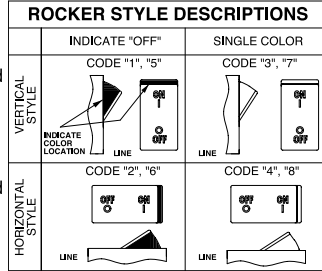

3 POLES 2

- 1 One
- 2 Two
- 3 Three

4 CIRCUIT

- A³ Switch Only (No Coil)
- B Series Trip (Current)
- C Series Trip (Voltage)
- D⁴ Shunt Trip (Current)
- E⁴ Shunt Trip (Voltage)
- F⁴ Relay Trip (Current)
- G⁴ Relay Trip (Voltage)
- H^{4,5} Dual Coil with Shunt Trip Voltage Coil
- K^{4,5} Dual Coil with Relay Trip Voltage Coil

5 AUXILIARY / ALARM SWITCH 6,7

- 0 without Aux Switch
- 1 S.P.D.T., 0.093 Q.C. Term.
- 2 S.P.D.T., 0.110 Q.C. Term.
- 4 S.P.D.T., 0.110 Q.C. Term. (Gold Contacts)
- 5 S.P.S.T., 0.093 Q.C. Term. (Gold Contacts)
- 7 S.P.S.T., 0.110 Q.C. Term. (Gold Contacts)
- 8 S.P.S.T., 0.187 Q.C. Term.
- 9 S.P.D.T., 0.187 Q.C. Term.

6 FREQUENCY & DELAY

- 03 DC 50/60Hz, Switch Only
- 10⁶ DC Instantaneous
- 11 DC Ultra Short
- 12 DC Short
- 14 DC Medium
- 16 DC Long
- 20⁶ 50/60Hz Instantaneous
- 21 50/60Hz Ultra Short
- 22 50/60Hz Short
- 24 50/60Hz Medium
- 26 50/60Hz Long
- 30 DC, 50/60Hz Instantaneous
- 31 DC, 50/60Hz Ultra Short
- 32 DC, 50/60Hz Short
- 34 DC, 50/60Hz Medium
- 36 DC, 50/60Hz Long
- 42⁹ 50/60Hz Short, Hi-Inrush
- 44⁹ 50/60Hz Medium, Hi-Inrush
- 46⁹ 50/60Hz Long, Hi-Inrush
- 52⁹ DC, Short, Hi-Inrush
- 54⁹ DC, Medium, Hi-Inrush
- 56 DC, Long, Hi-Inrush

7 CURRENT RATING (AMPERES)

| CODE | AMPERES | | | | | | |
|------|---------|-----|-------|-----|--------|-----|--------|
| 020 | 0.020 | 225 | 0.250 | 420 | 2.000 | 611 | 11.000 |
| 025 | 0.025 | 230 | 0.300 | 522 | 2.250 | 711 | 11.500 |
| 030 | 0.030 | 235 | 0.350 | 527 | 2.750 | 612 | 12.000 |
| 035 | 0.035 | 240 | 0.400 | 430 | 3.000 | 712 | 12.500 |
| 040 | 0.040 | 245 | 0.450 | 435 | 3.500 | 613 | 13.000 |
| 045 | 0.045 | 250 | 0.500 | 440 | 4.000 | 614 | 14.000 |
| 050 | 0.050 | 255 | 0.550 | 445 | 4.500 | 615 | 15.000 |
| 055 | 0.055 | 260 | 0.600 | 450 | 5.000 | 616 | 16.000 |
| 060 | 0.060 | 265 | 0.650 | 455 | 5.500 | 617 | 17.000 |
| 065 | 0.065 | 270 | 0.700 | 460 | 6.000 | 618 | 18.000 |
| 070 | 0.070 | 275 | 0.750 | 465 | 6.500 | 620 | 20.000 |
| 075 | 0.075 | 280 | 0.800 | 470 | 7.000 | 622 | 22.000 |
| 080 | 0.080 | 285 | 0.850 | 475 | 7.500 | 624 | 24.000 |
| 085 | 0.085 | 290 | 0.900 | 480 | 8.000 | 625 | 25.000 |
| 090 | 0.090 | 295 | 0.950 | 485 | 8.500 | 630 | 30.000 |
| 095 | 0.095 | 410 | 1.000 | 490 | 9.000 | 635 | 35.000 |
| 210 | 0.100 | 512 | 1.250 | 495 | 9.500 | 640 | 40.000 |
| 215 | 0.150 | 415 | 1.500 | 610 | 10.000 | 645 | 45.000 |
| 220 | 0.200 | 517 | 1.750 | 710 | 10.500 | 650 | 50.000 |

OR VOLTAGE COIL (NORMAL RATED VOLTAGE) 8

| CODE | AMPERES | | | | |
|------|---------|-----|-------|-----|--------|
| A06 | 6 DC | A32 | 32 DC | J12 | 12 AC |
| A12 | 12 DC | A48 | 48 DC | J18 | 18 AC |
| A18 | 18 DC | A65 | 65 DC | J24 | 24 AC |
| A24 | 24 DC | J06 | 6 AC | J48 | 48 AC |
| | | | | J65 | 65 AC |
| | | | | K20 | 120 AC |
| | | | | L40 | 240 AC |

8 TERMINAL 11

- 1¹² Push-On 0.250 Tab (Q.C.)
- 2 Screw 8-32 with upturned lugs
- 3¹³ Screw 8-32 (Bus Type)
- 4 Screw 10-32 with upturned lugs
- 5¹³ Screw 10-32 (Bus Type)
- 6 Screw 8-32 with upturned lugs & 30° bend
- 7 Screw 8-32 (Bus Type) & 30° bend
- 8 Screw 10-32 with upturned lugs & 30° bend
- 9 Screw 10-32 (Bus Type) & 30° bend
- B Screw M5 with upturned lugs
- C Screw M4 with upturned lugs
- E¹³ Screw M4 (Bus Type)
- F Screw M5 with upturned lugs & 30° bend
- G Screw M5 (Bus Type) & 30° bend
- H¹³ Screw M5 (Bus Type)
- L¹⁴ 0.250 Q.C./ Solder Lug
- M¹³ M6 Threaded Stud
- P¹⁵ Printed Circuit Board Terminals
- Q Push-In Stud
- R Screw M4 with upturned lugs & 30° bend
- S¹⁶ Push-On 0.110 Tab (Q.C.) & 30° bend
- T Screw M4 (Bus Type) & 30° bend

9 ACTUATOR COLOR & LEGEND

| Actuator or Visi-Color 17 | Marking: | | Marking Color | |
|---------------------------|----------|---------|---------------|-------------|
| | ON-OFF | Dual 17 | Single Color | Visi-Rocker |
| White | B | 1 | Black | White |
| Black | D | 2 | White | n/a |
| Red | G | 3 | White | Red |
| Green | J | 4 | White | Green |
| Blue | L | 5 | White | Blue |
| Yellow | N | 6 | Black | Yellow |
| Gray | Q | 7 | Black | Gray |
| Orange | S | 8 | Black | Orange |

10 MOUNTING / BARRIERS 18

| | STANDARD ROCKER BEZEL Threaded Insert, 2 per pole | FLAT ROCKER ACTUATOR | BARRIERS |
|---|---|----------------------|----------|
| A | 6-32 x 0.195 inches | | no |
| 1 | 6-32 X 0.195 inches (multi-pole units only) | | yes |
| 2 | ISO M3 x 5mm | | no |
| B | ISO M3 x 5mm (multi-pole units only) | | yes |
| | RECESSED OFF SIDE ROCKER ACTUATOR 19 | | |
| E | 6-32 x 0.195 inches | | no |
| 5 | 6-32 x 0.195 inches (multi-pole units only) | | yes |
| 6 | ISO M3 x 5mm | | no |
| F | ISO M3 x 5mm (multi-pole units only) | | yes |
| | PUSH-TO-RESET BEZEL, Threaded Insert, 2 per pole | | |
| 3 | 6-32 x 0.195 inches | | no |
| C | 6-32 x 0.195 inches (multi-pole units only) | | yes |
| 4 | ISO M3 x 5mm | | no |
| D | ISO M3 x 5mm (multi-pole units only) | | yes |

11 AGENCY APPROVAL

- C UL Recognized & CSA Accepted
- E TUV Certified, UL Recognized & CSA Accepted
- I UL Recognized STD 1077, UL Recognized 1500 (ignition protected), & CSA Accepted

Notes:

- 1 Push-To-Reset actuators have OFF portion of rocker shrouded.
- 2 Multi-pole breakers have all breakers identical except when specifying Auxiliary switch and/or mixed poles, and have one rocker per breaker.
- 3 Switch Only circuits, rated up to 50 amps & 3 poles. Only available when tied to a protected pole. For .02 to 30 amps, select Current Code 630. For 35 - 50 amps, select Current Code 650.
- 4 Available with terminal Codes 1, 2 and 3. Current Rating limited to 30 amps maximum.
- 5 Consult factory for Dual Coil options, as special catalog number is required. With Shunt construction, Dual Coils will trip instantaneously on line voltage. Dual coils require 30VA minimum power to trip and are rated for intermittent duty only.
- 6 Auxiliary Switch breakers with Series Trip & Switch Only circuits: ≤30A, are supplied with standard half shells. 30-50A are supplied with extended boat (B-Style) half shells.
- 7 On multi-pole breakers, one auxiliary switch is supplied, mounted in the extreme right pole.
- 8 Separate pole type voltage coils not rated for continuous duty. Available only with delay codes 10 & 20.
- 9 Available with Circuit Codes B & D only. UL Recognized, CSA Accepted & TUV Certified to 50 amps.
- 10 UL Recognition, CSA Acceptance & TUV Certification available in one and two pole breakers.
- 11 Screw Terminals are recommended on ratings greater than 20 amps. Ratings over 30 amps are only available with Terminal Codes 5, 9, G, H, M and Q.
- 12 Terminal Code 1: Available up to 30 amps, but not recommended over 20 amps.
- 13 Terminal Codes 3, 5 E & H (Bus Type) with TUV, are supplied with Lock Washers; Terminal Code M (M6 Threaded Stud) with TUV is supplied with Lock and Flat Washers. These breakers are only TUV Certified when the washers are used.
- 14 TUV Cert. available up to 12 amps. UL Rec. & CSA Accepted available up to 30 amps.
- 15 Single pole breakers with Terminal Code P (Printed Circuit Board) are available up to 50 amps with UL Recognition, CSA Accepted & TUV Certification, with Circuit Codes A, B and C. Two pole breakers with Terminal Code P (Printed Circuit Board) are available up to 40 amps with UL Recognition and CSA Accepted with Circuit Codes A, B and C.
- 16 Terminal Code S used on voltage coil circuit constructions only.
- 17 Color shown is visi and legend with remainder of rocker black, Dual = ON-OFF/I-O legend.
- 18 Legend on Push-to-reset bezel/shroud is white with single color actuator codes 7 & 8. Legend on Push-To-Reset bezel/shroud matches Visi-Color of rocker with actuator codes 5 & 6.
- 19 Recessed "off-side" available with actuator codes 1, 2, 3 & 4. Legends on rocker are available in ink stamping only.

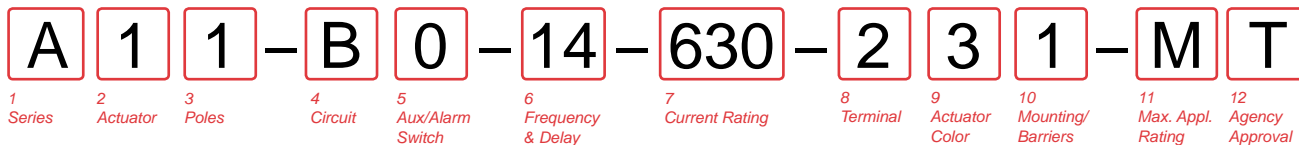

1 SERIES
A

2 ACTUATOR 1
Two Color Visi-Rocker
 1 Indicate OFF, vertical legend
 2 Indicate OFF, horizontal legend
Single color
 3 Vertical legend
 4 Horizontal legend
Push-To-Reset, Visi-Rocker
 5 Indicate OFF, vertical legend
 6 Indicate OFF, horizontal legend
Push-To-Reset, Single color
 7 Vertical legend
 8 Horizontal legend

| | INDICATE "OFF" | | SINGLE COLOR | |
|------------------|----------------|---------------|---------------|---------------|
| | CODE "1", "5" | CODE "3", "7" | CODE "1", "5" | CODE "3", "7" |
| VERTICAL STYLE | | | | |
| HORIZONTAL STYLE | | | | |

3 POLES 2
 1 One 2 Two 3 Three

4 CIRCUIT
 B Series Trip (Current)

5 AUXILIARY / ALARM SWITCH 3
 0 without Aux Switch 7 S.P.S.T., 0.110 Q.C. Term.
 1 S.P.D.T., 0.093 Q.C. Term. 8 S.P.S.T., 0.187 Q.C. Term.
 2 S.P.D.T., 0.110 Q.C. Term. 9 S.P.D.T., 0.187 Q.C. Term.

6 FREQUENCY & DELAY
 11 DC Ultra Short 52 DC, Short, Hi-Inrush
 12 DC Short 54 DC, Medium, Hi-Inrush
 14 DC Medium 56 DC, Long, Hi-Inrush
 16 DC Long

7 CURRENT RATING (AMPERES)

| CODE | AMPERES | CODE | AMPERES | CODE | AMPERES | CODE | AMPERES |
|------|---------|------|---------|------|---------|------|---------|
| 020 | 0.020 | 225 | 0.250 | 420 | 2.000 | 611 | 11.000 |
| 025 | 0.025 | 230 | 0.300 | 522 | 2.250 | 711 | 11.500 |
| 030 | 0.030 | 235 | 0.350 | 527 | 2.750 | 612 | 12.000 |
| 035 | 0.035 | 240 | 0.400 | 430 | 3.000 | 712 | 12.500 |
| 040 | 0.040 | 245 | 0.450 | 435 | 3.500 | 613 | 13.000 |
| 045 | 0.045 | 250 | 0.500 | 440 | 4.000 | 614 | 14.000 |
| 050 | 0.050 | 255 | 0.550 | 445 | 4.500 | 615 | 15.000 |
| 055 | 0.055 | 260 | 0.600 | 450 | 5.000 | 616 | 16.000 |
| 060 | 0.060 | 265 | 0.650 | 455 | 5.500 | 617 | 17.000 |
| 065 | 0.065 | 270 | 0.700 | 460 | 6.000 | 618 | 18.000 |
| 070 | 0.070 | 275 | 0.750 | 465 | 6.500 | 620 | 20.000 |
| 075 | 0.075 | 280 | 0.800 | 470 | 7.000 | 622 | 22.000 |
| 080 | 0.080 | 285 | 0.850 | 475 | 7.500 | 624 | 24.000 |
| 085 | 0.085 | 290 | 0.900 | 480 | 8.000 | 625 | 25.000 |
| 090 | 0.090 | 295 | 0.950 | 485 | 8.500 | 630 | 30.000 |
| 095 | 0.095 | 410 | 1.000 | 490 | 9.000 | 635 | 35.000 |
| 210 | 0.100 | 512 | 1.250 | 495 | 9.500 | 640 | 40.000 |
| 215 | 0.150 | 415 | 1.500 | 610 | 10.000 | 645 | 45.000 |
| 220 | 0.200 | 517 | 1.750 | 710 | 10.500 | 650 | 50.000 |

8 TERMINAL 5
 1 6 Push-On 0.250 Tab (Q.C.) 9 Screw 10-32 (Bus Type) & 30° bend
 2 Screw 8-32 with upturned lugs B Screw M5 with upturned lugs
 3 7 Screw 8-32 (Bus Type) F Screw M5 with upturned lugs & 30° bend
 4 Screw 10-32 with upturned lugs G Screw M5 (Bus Type) & 30° bend
 5 7 Screw 10-32 (Bus Type) H Screw M5 (Bus Type)
 6 Screw 8-32 with upturned lugs & 30° bend M 7 M6 Threaded Stud
 7 Screw 8-32 (Bus Type) & 30° bend P 8 Printed Circuit Board Terminals
 8 Screw 10-32 with upturned lugs & 30° bend Q 9 Push-In Stud

9 ACTUATOR COLOR & LEGEND

| Actuator or Visi-Color 11 | Marking: | | Marking Color | |
|---------------------------|----------|---------|---------------|-------------|
| | ON-OFF | Dual 11 | Single Color | Visi-Rocker |
| White | B | 1 | Black | White |
| Black | D | 2 | White | n/a |
| Red | G | 3 | White | Red |
| Green | J | 4 | White | Green |
| Blue | L | 5 | White | Blue |
| Yellow | N | 6 | Black | Yellow |
| Gray | Q | 7 | Black | Gray |
| Orange | S | 8 | Black | Orange |

10 MOUNTING / BARRIERS 12

| | STANDARD ROCKER BEZEL | BARRIERS |
|---|--|----------|
| | Threaded Insert, 2 per pole | |
| | FLAT ROCKER ACTUATOR | |
| 1 | 6-32 x 0.195 inches | no |
| A | 6-32 X 0.195 inches (multi-pole units only) | yes |
| 2 | ISO M3 x 5mm | no |
| B | ISO M3 x 5mm (multi-pole units only) | yes |
| | RECESSED OFF SIDE ROCKER ACTUATOR | |
| 5 | 6-32 x 0.195 inches | no |
| E | 6-32 x 0.195 inches (multi-pole units only) | yes |
| 6 | ISO M3 x 5mm | no |
| F | ISO M3 x 5mm (multi-pole units only) | yes |
| | PUSH-TO-RESET BEZEL, Threaded Insert, 2 per pole | |
| 3 | 6-32 x 0.195 inches | no |
| C | 6-32 x 0.195 inches (multi-pole units only) | yes |
| 4 | ISO M3 x 5mm | no |
| D | ISO M3 x 5mm (multi-pole units only) | yes |

11 MAXIMUM APPLICATION RATING
 M 80 DC

12 AGENCY APPROVAL
 T UL489A Listed
 J UL489A Listed, TUV Certified

- Notes:
- 1 Push-To-Reset actuators have OFF portion of rocker shrouded.
 - 2 Multi-pole breakers have all breakers identical except when specifying Auxiliary switch and/or mixed poles, and have one rocker per breaker.
 - 3 Auxiliary Switch breakers with Series Trip circuits: ≤ 30A, are supplied with standard half shells. 30-50A are supplied with extended boat (B-Style) half shells.
 - 4 VDE Certification available with single pole breakers only. UL489A Listing available with one and two pole breakers.
 - 5 Screw Terminals are recommended on ratings greater than 20 amps. Ratings over 30 amps are only available with Terminal Codes 5, 9, G, H, M and Q.
 - 6 Terminal Code 1 (Push-On) available up to 25 amps with TUV or VDE Certification and 30 amps with UL489A Listing, but is not recommended over 20 amps.
 - 7 Terminal Codes 3, 5 and H (Bus Type) with TUV or VDE, are supplied with Lock Washers, and Terminal Code M (M6 Threaded Stud) with VDE is supplied with Lock and Flat Washers. These breakers are only TUV or VDE Certified when the washers are used.
 - 8 Single pole breakers with Terminal Code P (Printed Circuit Board) are available up to 30 amps with VDE Certification and 50 amps with UL489A Listing.
 - 9 Terminal Code Q not available with VDE certification.
 - 10 Color shown is Visi and Legend with remainder of rocker black. Dual = ON-OFF/I-O legend.
 - 11 Legend on Push-to-reset bezel/shroud is white with single color actuator codes R & U.
 - 12 Legend on Push-To-Reset bezel/shroud matches Visi-Color of rocker with actuator codes N & O. Rockerguard available with actuator codes C through K

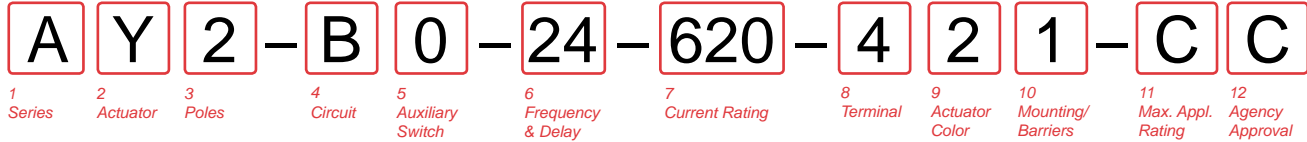
**1 SERIES****A****2 ACTUATOR¹****Y** Single Color Recessed Paddle Actuator with Vertical Legends**3 POLES²****1** One **2** Two **3** Three**4 CIRCUIT**

| | |
|--------------------------------|---|
| A Switch-Only (No Coil) | F Relay Trip (Current) |
| B Series Trip (Current) | G Relay Trip (Voltage) |
| C Series Trip (Voltage) | H Dual Coil with Shunt Trip Voltage Coil |
| D Shunt Trip (Current) | K Dual Coil with Shunt Trip Current Coil |
| E Shunt Trip (Voltage) | |

5 AUXILIARY SWITCH

| |
|--|
| 0 without Aux Switch |
| 1 S.P.D.T. with 0.093 Q.C. Terminals |
| 2 S.P.D.T. with 0.110 Q.C. Terminals |
| 3 S.P.D.T. with 0.139 Solder Lug Terminals |
| 4 S.P.D.T. with 0.110 Q.C. Terminals (Gold Contacts) |
| 5 S.P.D.T. with 0.093 Q.C. Terminals (Gold Contacts) |
| 6 S.P.S.T.-N.O. with 0.139 Solder Lug Terminals |
| 7 S.P.S.T.-N.O. with 0.110 Q.C. Terminals (Gold Contacts) |
| 8 S.P.S.T.-N.O. with 0.187 Q.C. Terminals |
| 9 S.P.D.T. with 0.187 Q.C. Terminals |

6 FREQUENCY & DELAY³

| | |
|-----------------------------------|-------------------------------------|
| 3 DC, 50/60 Hz Switch Only | 22 50/60 Hz Short |
| 10 DC Instantaneous | 24 50/60 Hz Medium |
| 11 DC Ultra Short | 26 50/60 Hz Long |
| 12 DC Short | 42 50/60 Hz Short Hi-Inrush |
| 14 DC Medium | 44 50/60 Hz Medium Hi-Inrush |
| 16 DC Long | 46 50/60 Hz Long Hi-Inrush |
| 20 50/60 Hz Instantaneous | 52 DC, Short, Hi-Inrush |
| 21 50/60 Hz Ultra Short | 54 DC, Medium, Hi-Inrush |
| | 56 DC, Long, Hi-Inrush |

7 CURRENT RATING (AMPERES)⁴

| CODE | AMPERES | | | | |
|------------|---------|------------|-------|------------|--------|
| 220 | 0.200 | 295 | 0.950 | 460 | 6.000 |
| 225 | 0.250 | 410 | 1.000 | 465 | 6.500 |
| 230 | 0.300 | 512 | 1.250 | 470 | 7.000 |
| 235 | 0.350 | 415 | 1.500 | 475 | 7.500 |
| 240 | 0.400 | 517 | 1.750 | 480 | 8.000 |
| 245 | 0.450 | 420 | 2.000 | 485 | 8.500 |
| 250 | 0.500 | 522 | 2.250 | 490 | 9.000 |
| 255 | 0.550 | 425 | 2.500 | 495 | 9.500 |
| 260 | 0.600 | 527 | 2.750 | 610 | 10.000 |
| 265 | 0.650 | 430 | 3.000 | 710 | 10.500 |
| 270 | 0.700 | 435 | 3.500 | 611 | 11.000 |
| 275 | 0.750 | 440 | 4.000 | 711 | 11.500 |
| 280 | 0.800 | 445 | 4.500 | 612 | 12.000 |
| 285 | 0.850 | 450 | 5.000 | 712 | 12.500 |
| 290 | 0.900 | 455 | 5.500 | 613 | 13.000 |

OR VOLTAGE COIL (NORMAL RATED VOLTAGE)

| CODE | AMPERES | | | | |
|------------|---------|------------|-------|------------|--------|
| A06 | 6 DC | A32 | 32 DC | J12 | 12 AC |
| A12 | 12 DC | A48 | 48 DC | J18 | 18 AC |
| A18 | 18 DC | A65 | 65 DC | J24 | 24 AC |
| A24 | 24 DC | J06 | 6 AC | J48 | 48 AC |
| | | | | J65 | 65 AC |
| | | | | K20 | 120 AC |
| | | | | L40 | 240 AC |

8 TERMINAL

| | |
|--|--|
| 1 Push-On 0.250 Tab (Q.C.) | C Screw, M4 with upturned lugs |
| 2 Screw 8-32 with upturned lugs | E Screw, M4 (Bus Type) |
| 3 Screw 8-32 (Bus Type) | F Screw M5 with upturned lugs & 30° bend |
| 4 Screw 10-32 with upturned lugs | G Screw M5 (Bus Type) & 30° bend |
| 5 Screw 10-32 (Bus Type) | H Screw M5 (Bus Type) |
| 6 Screw 8-32 with upturned lugs & 30° bend | L 0.250 Q.C./Solder Lug |
| 7 Screw 8-32 (Bus Type) & 30° bend | M M6 Threaded Stud |
| 8 Screw 10-32 with upturned lugs & 30° bend | P Printed Circuit Board Terminals |
| 9 Screw 10-32 (Bus Type) & 30° bend | Q Push-In Stud |
| B Screw M5 with upturned lugs | R Screw, M4 with upturned lugs & 30° Bend |
| | S Screw, M5 with upturned lugs |
| | T Screw, M4 with upturned lugs |

9 ACTUATOR COLOR & LEGEND⁵

| Actuator Color | I-O | ON-OFF | Dual | Legend Color |
|----------------|----------|----------|----------|--------------|
| White | A | B | 1 | Black |
| Black | C | D | 2 | White |
| Red | F | G | 3 | White |
| Green | H | J | 4 | White |
| Blue | K | L | 5 | White |
| Yellow | M | N | 6 | Black |
| Gray | P | Q | 7 | Black |
| Orange | R | S | 8 | Black |

10 MOUNTING / BARRIERS

| | BARRIERS |
|--|----------|
| 1 6-32 x 0.195 inches | no |
| A 6-32 X 0.195 inches (multi-pole units only) | yes |
| 2 ISO M3 x 5mm | no |
| B ISO M3 x 5mm (multi-pole units only) | yes |

11 MAXIMUM APPLICATION RATING⁶

| |
|--|
| A 65 VDC |
| C 120/240 VAC (Available only on 2 or 3-Pole units) |
| K 120 VAC |
| M 80 DC |

12 AGENCY APPROVAL⁷

| |
|---|
| A Without Approvals |
| C UL Recognized and CSA Accepted |
| T UL 489A |

Notes:

- All standard catalog numbers are supplied with Vertical Legends. For Horizontal or other non-standard legends, choose "X" and order as a special catalog number.
- For rating (T) 2 & 3 Pole not available.
- Frequency and Time Delay ratings of (03, 20, 21, 22, 24, 26, 42, 44, 46) not available with approval T.
- Voltage Coil Ratings starting with (J, K, or L) not available with approval T.
- "OFF" and/or "O" Legends are on Bracket and are only visible when the Paddle Actuator is in the off position.
- Maximum Application Ratings (C & K) not available with approval T.
- Not all approvals are available in all constructions. Consult factory for details.

Circuit & Terminal Diagrams: in. [mm]

| CIRCUIT BREAKER PROFILE | CIRCUIT SCHEMATIC | | CIRCUIT CODE | AUX. SWITCH CODE | CIRCUIT SCHEMATIC | | CIRCUIT CODE | AUX. SWITCH CODE |
|-------------------------|--|-----|--------------|------------------|---|-----|--------------|------------------|
| | ANSI | IEC | | | ANSI | IEC | | |
| 2 TERMINALS | SWITCH ONLY (NO COIL) | | A | 0 | SERIES TRIP | | B C | 0 |
| 5 TERMINALS | SWITCH ONLY (NO COIL) WITH AUXILIARY SWITCH (4) | | A | 1 2 3 4 | SERIES TRIP WITH AUXILIARY SWITCH (4) | | B C | 1 2 3 4 |
| 3 TERMINALS | SHUNT TRIP | | D E | 0 | DUAL COIL; SERIES TRIP CURRENT COIL, SHUNT TRIP VOLTAGE COIL | | H | 0 |
| 4 TERMINALS | RELAY TRIP | | F G | 0 | DUAL COIL; SERIES TRIP CURRENT COIL, RELAY TRIP VOLTAGE COIL | | K | 0 |

| TERMINAL DESCRIPTION | | DEPTH BEHIND PANEL |
|--------------------------|-----------------------------|--------------------|
| MAIN | TAB (Q.C.) | 2.370 [60.20] |
| | SCREW TYPE | 2.402 [61.01] |
| SHUNT, RELAY & DUAL COIL | TAB (Q.C.) | 2.577 [65.46] |
| | SCREW #8-32 W/UPTURNED LUGS | 2.734 [69.44] |
| AUX. SWITCH* | .093 TAB (Q.C.) | 2.465 [62.61] |
| | .110 TAB (Q.C.) | 2.559 [65.00] |
| | SOLDER TYPE | 2.340 [59.44] |

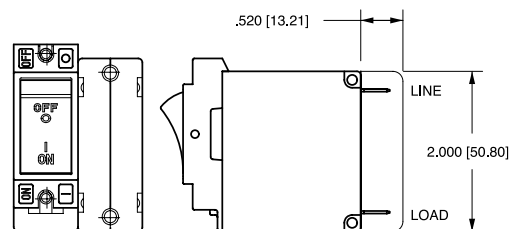

* AVAILABLE ON SERIES TRIP AND SWITCH ONLY CIRCUITS. WHEN CALLED FOR ON MULTI-POLE UNITS, ONLY ONE AUX. SWITCH IS NORMALLY SUPPLIED, AS VIEWED IN MULTI-POLE IDENTIFICATION SCHEME.

BARRIER FOR UL-RECOGNIZED MULTI-POLE BREAKERS

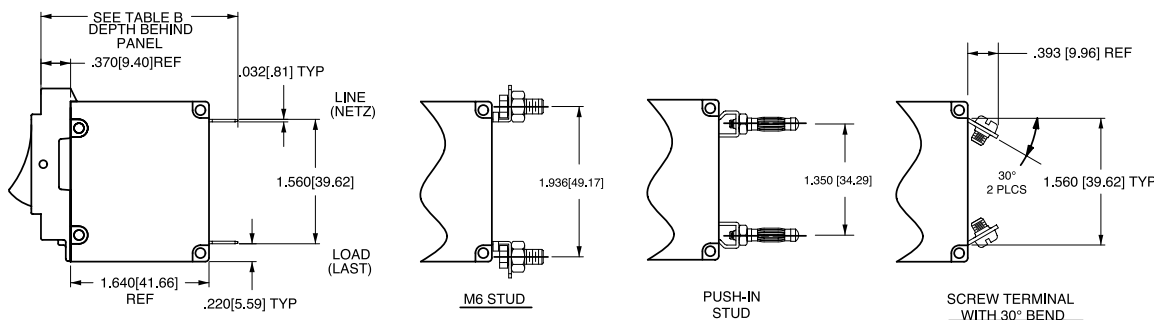

- Notes:
- 1 All dimensions are in inches [millimeters].
 - 2 Tolerance $\pm .020$ [.51] unless otherwise specified.
 - 3 Schematic shown represents current trip circuit.
 - 4 Circuits shown for >30 amps / VDE.

Dimensional Specifications: in. [mm]

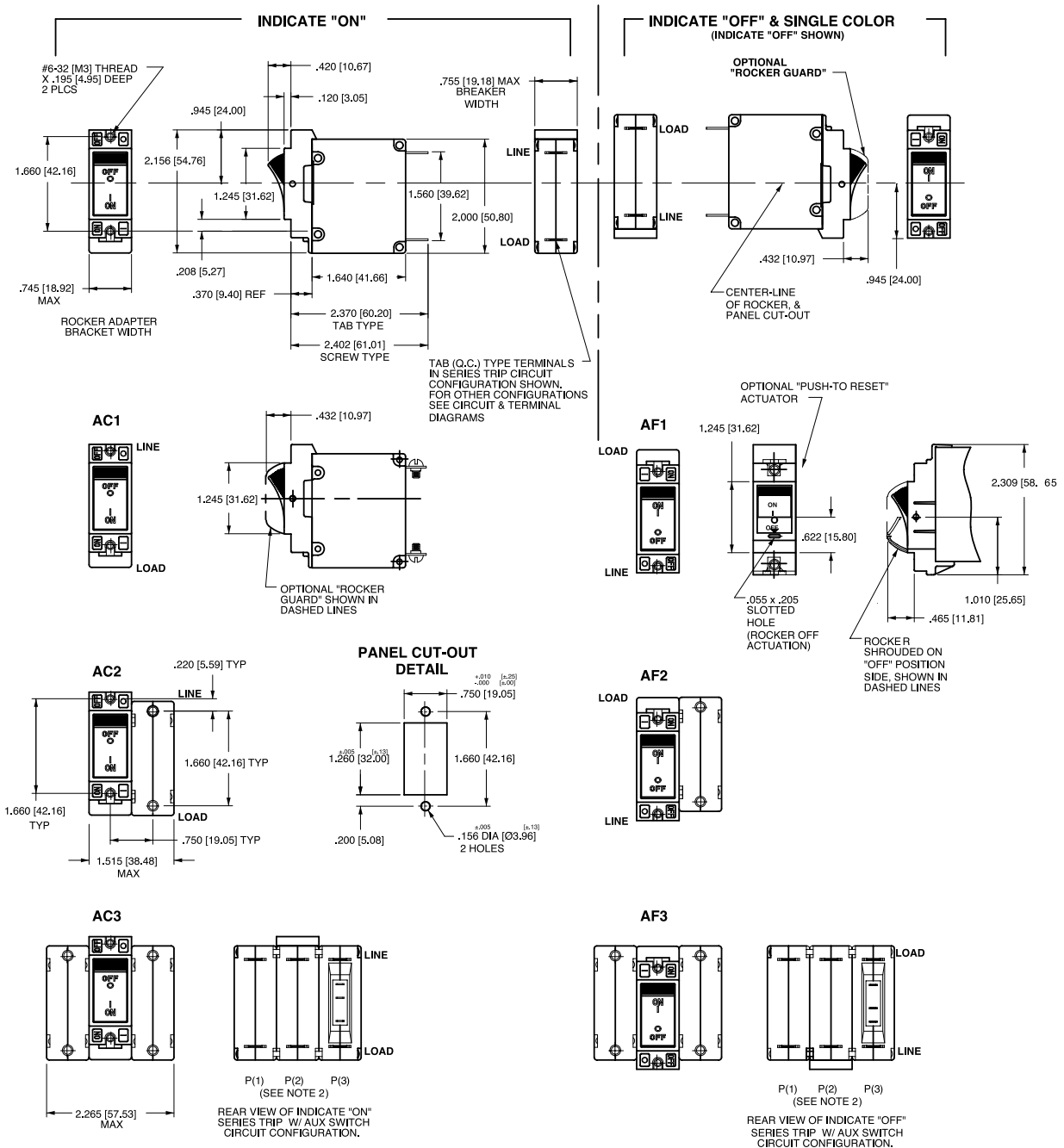

Notes:

- 1 Dimensions apply to all variations shown. Notice that circuit breaker line & load terminal orientation on indicate OFF is opposite of indicate ON.
- 2 For pole orientation with horizontal legend, rotate front view clockwise 90°.
- 3 All dimensions are in inches [millimeters].
- 4 Tolerance ± 0.20 [.51] unless otherwise specified.

Dimensional Specifications: in. [mm]

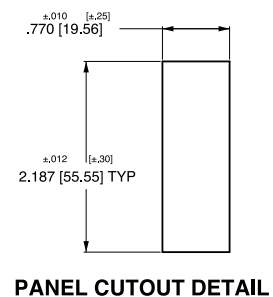
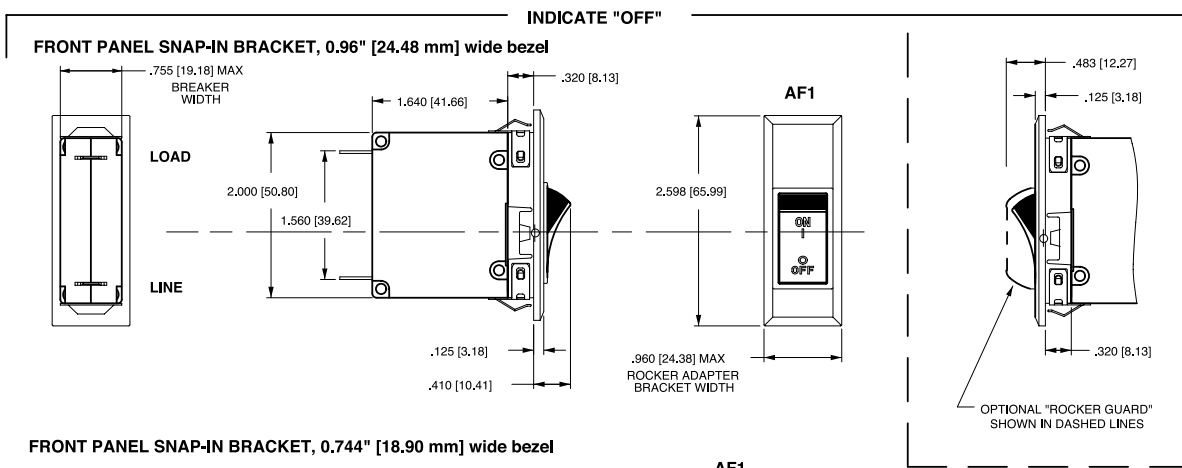
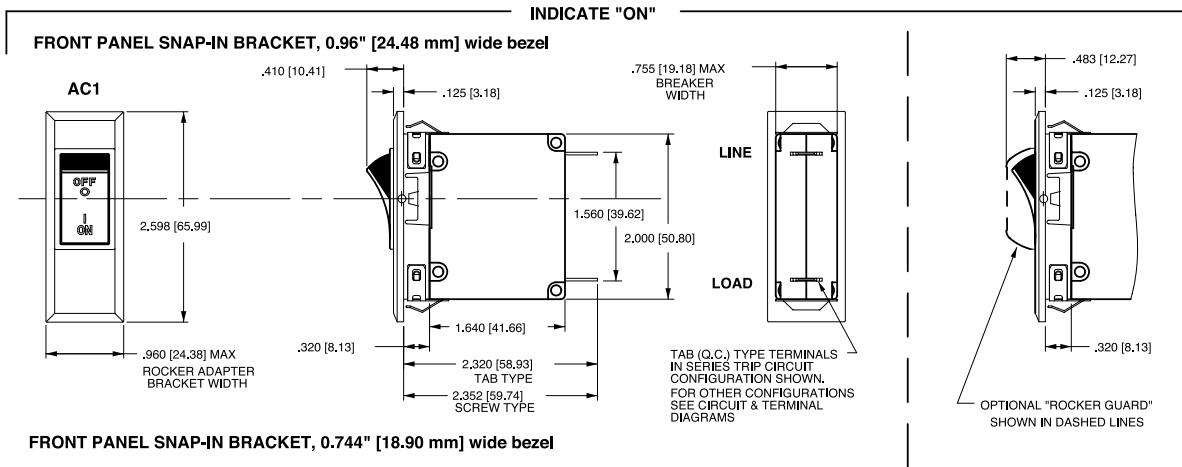

- Notes:
- 1 Dimensions apply to all variations shown. Notice that circuit breaker line & load terminal
 - 2 For pole orientation with horizontal legend, rotate front view clockwise 90°. Orientation on indicate "OFF" is opposite of indicate "ON"
 - 3 Recommended panel thickness: .040 [1.02] to .100 [2.54]
 - 4 All dimensions are in Inches [millimeters].
 - 5 Tolerance ± 0.020 [1.51] unless otherwise specified.

Dimensional Specifications: in. [mm]

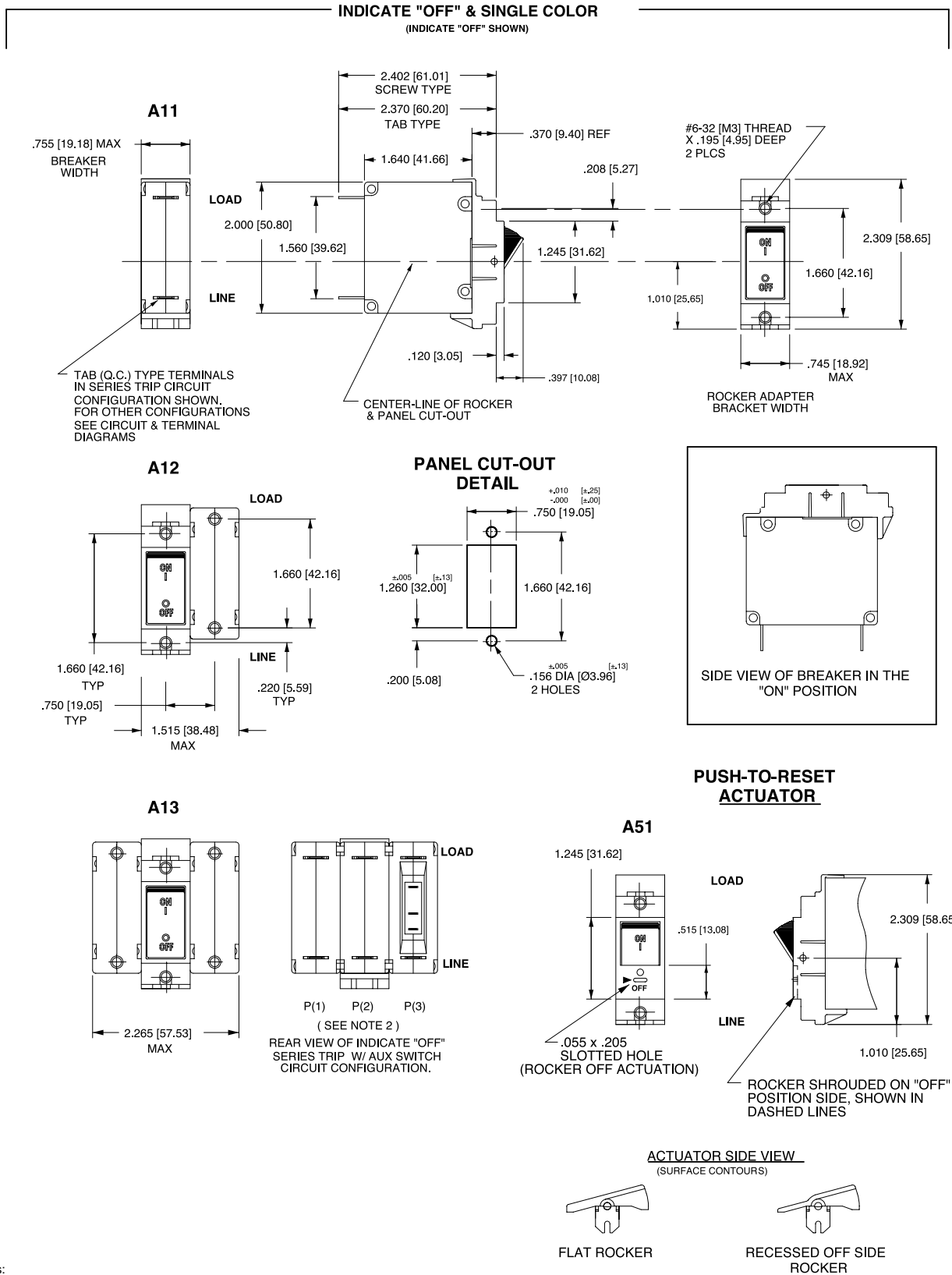

- Notes:
- 1 All dimensions are in inches [millimeters].
 - 2 For pole orientation with horizontal legend, rotate front view clockwise 90°.
 - 3 Tolerance ± 0.20 [.51] unless otherwise specified.

Dimensional Specifications: in. [mm]

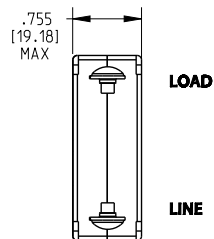
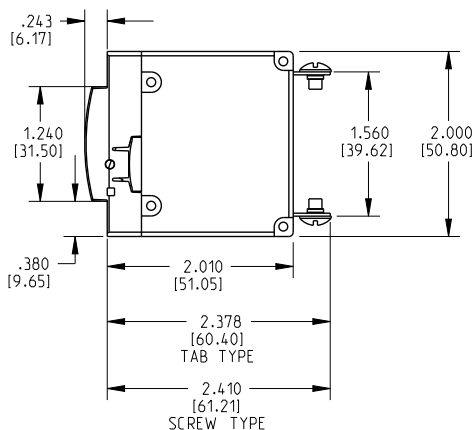
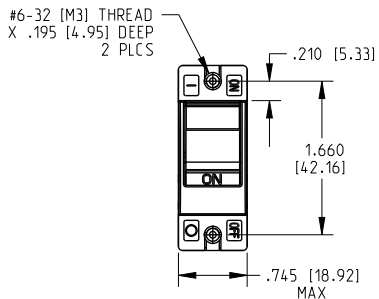

BREAKER SHOWN IN THE OFF POSITION

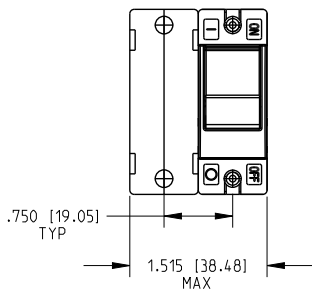

BREAKER SHOWN IN THE OFF POSITION

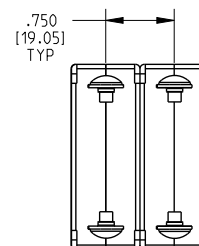
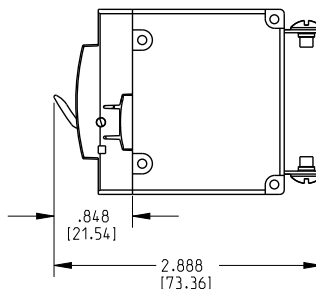

PANEL CUT-OUT DETAIL

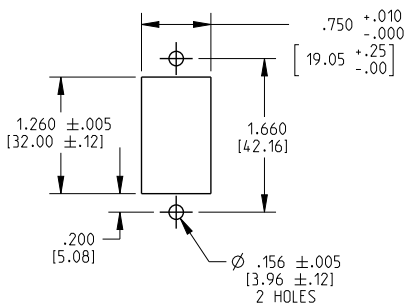
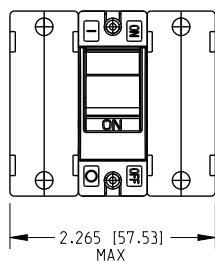

Notes:

- 1 All dimensions are in inches [millimeters].
- 2 Tolerance ± 0.20 [51] unless otherwise specified

PC Terminal Diagrams: in. [mm]

A-SERIES ROCKER

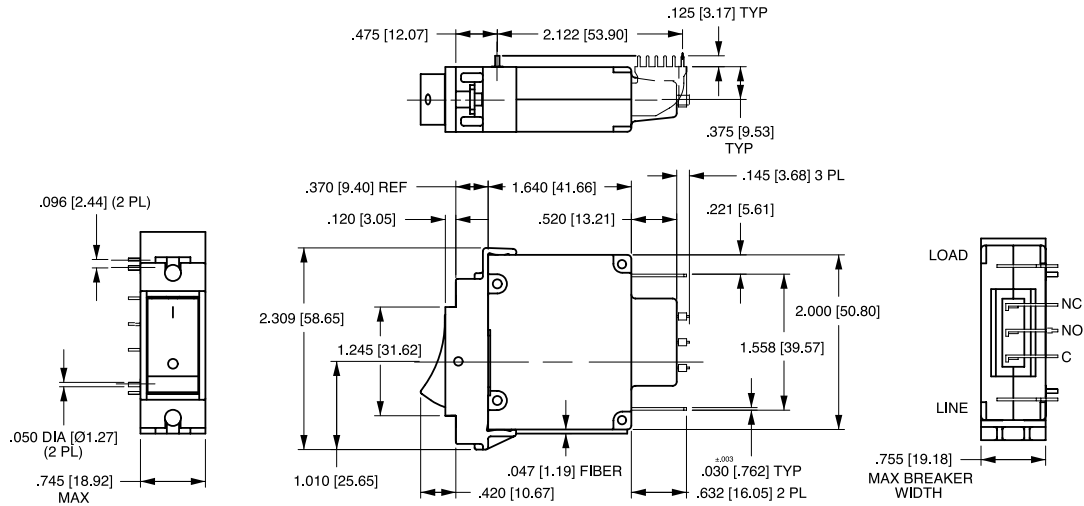

A-SERIES HANDLE

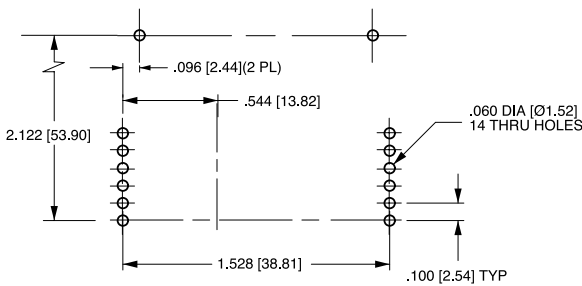
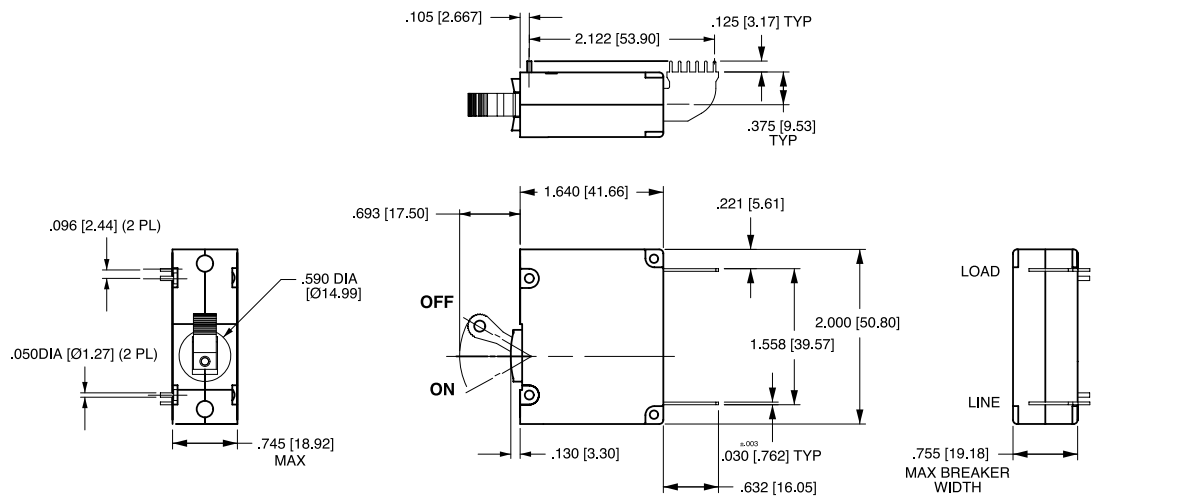

P.C. FOOT PRINT

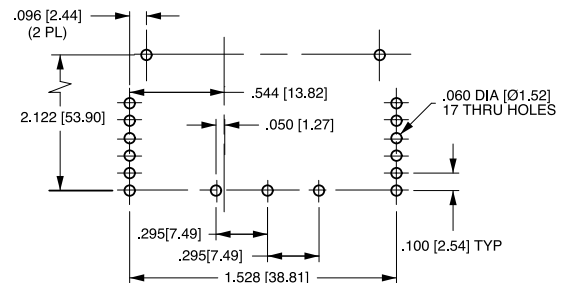

P.C. FOOT PRINT WITH AUX. SWITCH

- Notes:
- 1 Drawing illustrates A-Series with VDE certification.
 - 2 All dimensions are in inches [millimeters].
 - 3 Tolerance ± 0.20 [.51] unless otherwise specified

Authorized Sales Representatives

Click on the group name on the map below to find your local representative or visit www.carlingtech.com/findarep.

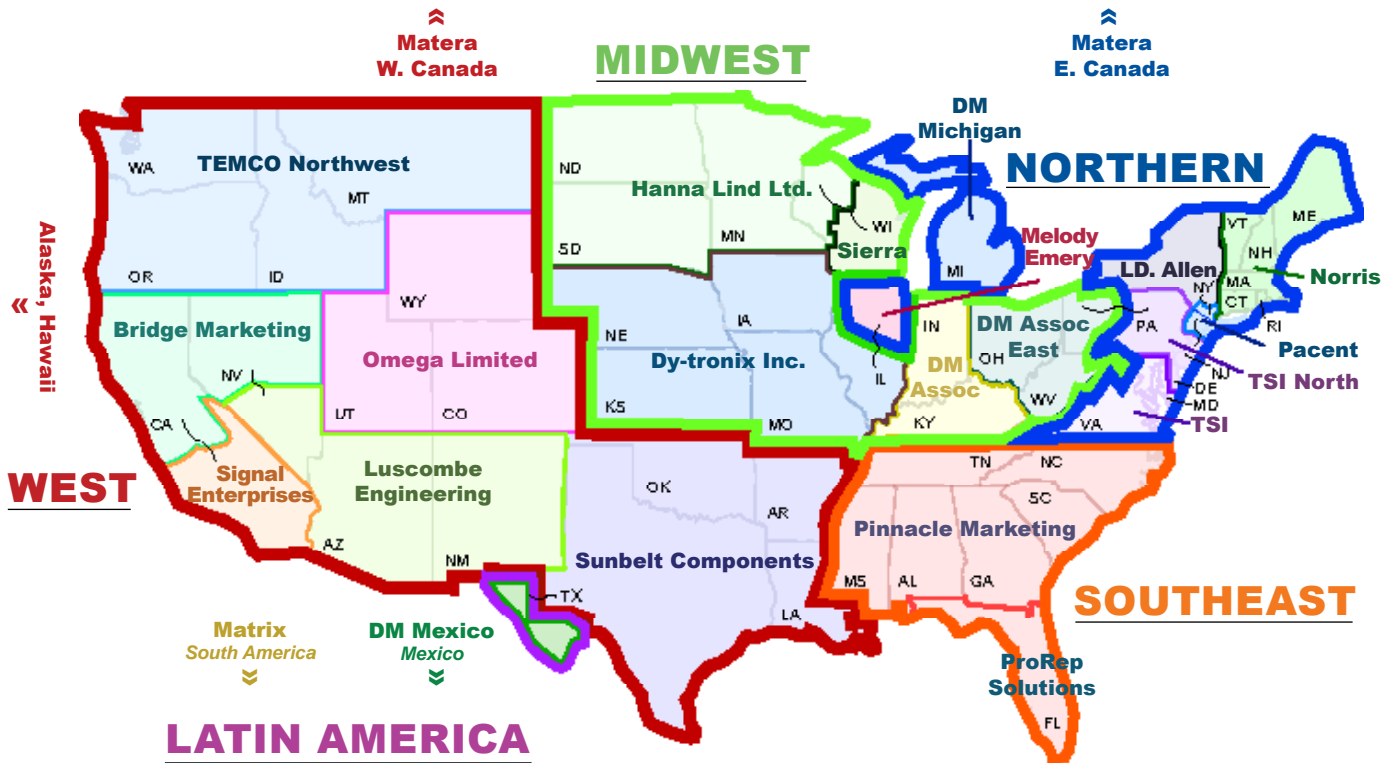

About Carling

Founded in 1920, Carling Technologies is a leading manufacturer of electrical and electronic switches and assemblies, circuit breakers, electronic controls, power distribution units, and multiplexed power distribution systems. With four ISO registered manufacturing facilities and technical sales offices worldwide, Carling Technologies Sales, Service and Engineering teams do much more than manufacture electrical components, they engineer powerful solutions! To learn more about Carling please visit www.carlingtech.com/company-profile.

To view all of Carling’s environmental, quality, health & safety certifications please visit www.carlingtech.com/environmental-certifications

Worldwide Headquarters

Carling Technologies, Inc.
60 Johnson Avenue, Plainville, CT 06062
Phone: 860.793.9281 **Fax:** 860.793.9231
Email: sales@carlingtech.com

Northern Region Sales Office: nrsm@carlingtech.com
Southeast Region Sales Office: sersm@carlingtech.com
Midwest Region Sales Office: mrrsm@carlingtech.com
West Region Sales Office: wrsm@carlingtech.com
Latin America Sales Office: larsm@carlingtech.com

Asia-Pacific Headquarters

Carling Technologies, Asia-Pacific Ltd.,
Kowloon, Hong Kong
Phone: Int + 852-2737-2277 **Fax:** Int + 852-2736-9332
Email: sales@carlingtech.com.hk

Shenzhen, China: shenzhen@carlingtech.com
Shanghai, China: shanghai@carlingtech.com
Pune, India: india@carlingtech.com
Kaohsiung, Taiwan: taiwan@carlingtech.com
Yokohama, Japan: japan@carlingtech.com

Europe | Middle East | Africa Headquarters

Carling Technologies LTD
4 Airport Business Park, Exeter Airport,
Clyst Honiton, Exeter, Devon, EX5 2UL, UK
Phone: Int + 44 1392.364422 **Fax:** Int + 44 1392.364477
Email: ltd.sales@carlingtech.com

Germany: gmbh@carlingtech.com
France: sas@carlingtech.com



Carling Technologies™

Innovative Designs. Powerful Solutions.