

# AN17000A

## Audio signal processing IC for notebook PC

### ■ Overview

AN17000A has a speaker power amplifier, head-phone power amplifier, line amplifier, electronic volume and a bass boost circuit for notebook PC. This IC adopts a small thin package, enabling compact and a space saving set.

### ■ Features

- Possible speaker power is  
 1 W × 2-ch. : 8 Ω output at  $V_{CC} = 5\text{ V}$  or  
 0.5 W × 2-ch. : 8 Ω output at  $V_{CC} = 5\text{ V}$
- A gain and frequency response of bass boost can be adjusted with external components
- Each amplifiers has a standby and mute switch
- Small outline thin package (1.0 mm)

### ■ Applications

- Notebook PC
- LCD monitor with speakers for PC

### ■ Block Diagram

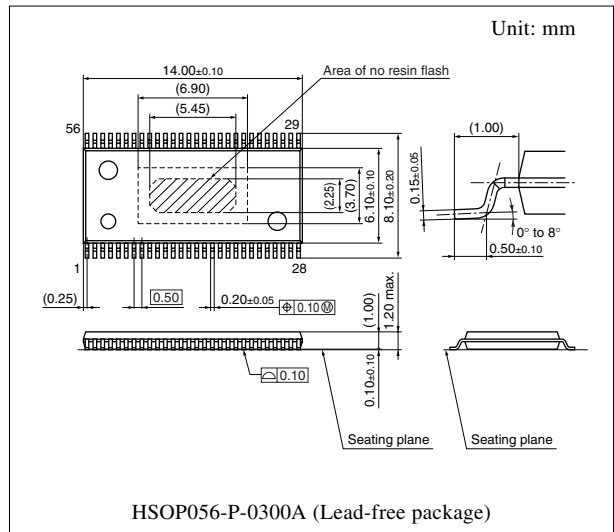
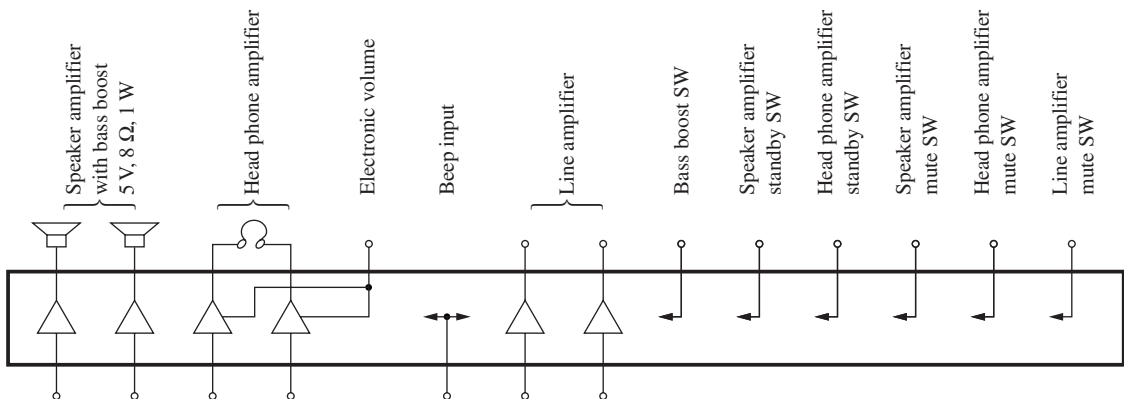

■ Application Circuit Example

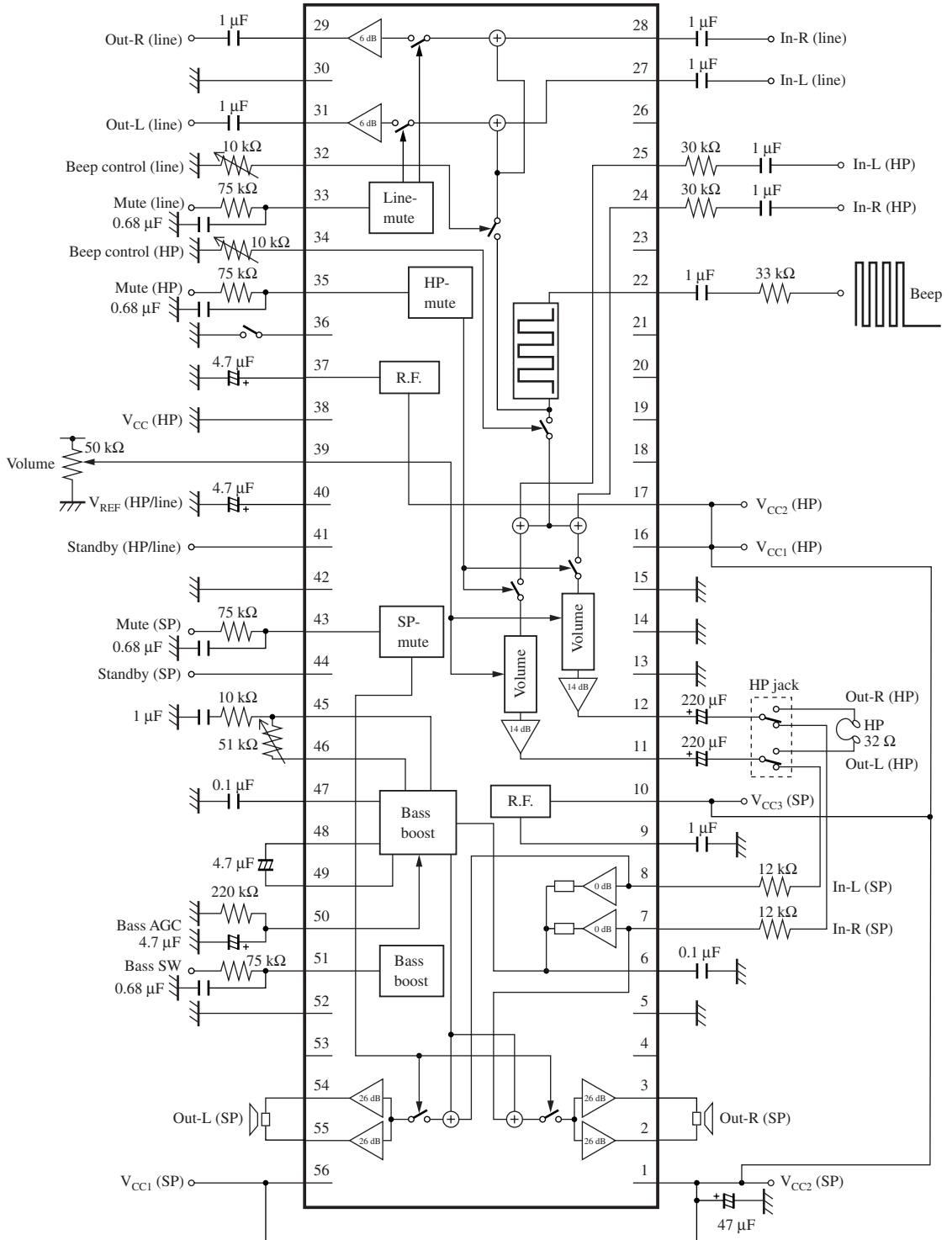

Note) \*1: Beep input notes

Don't set the input level to pin 22 to - 0.3 V or less.

\*2: Connect pin 32 and pin 34 to GND with a resistor of 1 kΩ or more resistance respectively.

\*3: Pin36 Short: 0.5 W; Open: 1 W

## ■ Pin Descriptions

| Pin No. | Description                             | Pin No. | Description                            |
|---------|---|---------|--|
| 1       | Power supply (R-ch. speaker power use)  | 29      | Line amplifier R-ch. output            |
| 2       | R-ch. speaker output 1                  | 30      | GND (line small signal use)            |
| 3       | R-ch. speaker output 2                  | 31      | Line amplifier L-ch. output            |
| 4       | N.C.                                    | 32      | Beep control (line)                    |
| 5       | GND (R-ch. SP power use)                | 33      | Line mute control                      |
| 6       | Bass boost capacitor 1                  | 34      | Beep control (HP)                      |
| 7       | Speaker R-ch. input                     | 35      | HP mute control                        |
| 8       | Speaker L-ch. input                     | 36      | Speaker power selector                 |
| 9       | Ripple filter (SP)                      | 37      | Ripple filter 1                        |
| 10      | Power supply (Speaker small signal use) | 38      | GND (Small signal use)                 |
| 11      | L-ch. headphone output                  | 39      | Volume control                         |
| 12      | R-ch. headphone output                  | 40      | Ripple filter 2                        |
| 13      | GND (HP power use)                      | 41      | Standby (HP/line)                      |
| 14      | GND (HP small signal use)               | 42      | N.C.                                   |
| 15      | N.C.                                    | 43      | SP mute control                        |
| 16      | Power supply (HP power use)             | 44      | Standby (SP)                           |
| 17      | Power supply (HP small signal use)      | 45      | R1 for bass boost gain                 |
| 18      | N.C.                                    | 46      | R2 for bass boost gain                 |
| 19      | N.C.                                    | 47      | Bass boost capacitor 2                 |
| 20      | N.C.                                    | 48      | Bass boost capacitor 3                 |
| 21      | N.C.                                    | 49      | Bass boost capacitor 4                 |
| 22      | Beep input                              | 50      | Bass boost AGC                         |
| 23      | N.C.                                    | 51      | Bass boost control                     |
| 24      | Headphone R-ch. input 2                 | 52      | GND (L-ch. SP power use)               |
| 25      | Headphone L-ch. input 1                 | 53      | N.C.                                   |
| 26      | N.C.                                    | 54      | L-ch. speaker output 2                 |
| 27      | Line amplifier L-ch. input              | 55      | L-ch. speaker output 1                 |
| 28      | Line amplifier R-ch. input              | 56      | Power supply (L-ch. speaker power use) |

### ■ Absolute Maximum Ratings

| Parameter                        | Symbol    | Rating      | Unit |
|----------------------------------|-----------|-------------|------|
| Supply voltage *2                | $V_{CC}$  | 5.75        | V    |
| Supply current                   | $I_{CC}$  | 1 200       | mA   |
| Power dissipation *3             | $P_D$     | 0.517       | W    |
| Operating ambient temperature *1 | $T_{opr}$ | -25 to +75  | °C   |
| Storage temperature *1           | $T_{stg}$ | -55 to +150 | °C   |

Note) \*1: Except for the operating ambient temperature and storage temperature, all ratings are for  $T_a = 25^\circ\text{C}$ .

\*2: Without signal

\*3:  $T_a = 75^\circ\text{C}$ , mounted on standard board.

### ■ Recommended Operating Range

| Parameter      | Symbol   | Range      | Unit |
|----------------|----------|------------|------|
| Supply voltage | $V_{CC}$ | 4.5 to 5.5 | V    |

### ■ Electrical Characteristics at $f = 1 \text{ kHz}$ , $V_{CC} = 5 \text{ V}$ , $T_a = 25^\circ\text{C}$

| Parameter  | Symbol       | Conditions  | Min | Typ | Max  | Unit          |
|--|--------------|---|-----|-----|------|---------------|
| Quiescent circuit current 1                            | $I_{T1}$     | Current of $V_{CC1(SP)}$ , $V_{CC2(SP)}$ , $V_{CC3(SP)} = 5 \text{ V}/(\text{no load})$ | —   | 7.5 | 13.1 | mA            |
| Quiescent circuit current 2                            | $I_{T2}$     | Current of $V_{CC1(HP)}$ , $V_{CC2(HP)} = 5 \text{ V}/(\text{no load})$                 | —   | 15  | 20   | mA            |
| Standby current 1                                      | $I_{ST1}$    | STB: On current of $V_{CC1(SP)}$ , $V_{CC2(SP)}$ , $V_{CC3(SP)} = 5 \text{ V}$          | —   | 0.1 | 50   | $\mu\text{A}$ |
| Standby current 2                                      | $I_{ST2}$    | STB: On current of $V_{CC1(HP)}$ , $V_{CC2(HP)} = 5 \text{ V}$                          | —   | 0.1 | 50   | $\mu\text{A}$ |
| <b>Speaker amplifier (<math>R_L = 8 \Omega</math>)</b> |              |   |     |     |      |               |
| L-ch. output voltage level *1                          | $V_{SPL}$    | $V_{IN} = -10 \text{ dBV}$<br>Pin 36: Open  | 1.5 | 4.0 | 6.5  | dBV           |
| R-ch. output voltage level *1                          | $V_{SPR}$    | $V_{IN} = -10 \text{ dBV}$<br>Pin 36: Open  | 1.5 | 4.0 | 6.5  | dBV           |
| L-ch. total harmonic distortion *1                     | $TH_{SL}$    | $V_{IN} = -10 \text{ dBV}$<br>Pin 36: Open  | —   | 0.2 | 0.5  | %             |
| R-ch. total harmonic distortion *1                     | $TH_{SR}$    | $V_{IN} = -10 \text{ dBV}$<br>Pin 36: Open  | —   | 0.2 | 0.5  | %             |
| L-ch. max. output power *1                             | $V_{MAXSL}$  | THD = 1%<br>Pin 36: Open  | 0.7 | 0.8 | —    | W             |
| R-ch. max. output power *1                             | $V_{MAXSR}$  | THD = 1%<br>Pin 36: Open  | 0.7 | 0.8 | —    | W             |
| L-ch. max. output power 1 *1                           | $V_{MAXSIL}$ | THD = 1%<br>Pin 36: Short to GND  | 0.3 | 0.4 | —    | W             |
| R-ch. max. output power 1 *1                           | $V_{MAXSIR}$ | THD = 1%<br>Pin 36: Short to GND  | 0.3 | 0.4 | —    | W             |
| L-ch. output noise voltage *2                          | $V_{NSL}$    | $R_g = 1 \text{ k}\Omega$<br>Pin 36: Open   | —   | -80 | -70  | dBV           |

Note) \*1: DIN audio filter is used.

\*2: A-curve filter is used.

**■ Electrical Characteristics at  $f = 1$  kHz,  $V_{CC} = 5$  V,  $T_a = 25^\circ\text{C}$  (continue)**

| Parameter  | Symbol      | Conditions   | Min   | Typ   | Max   | Unit |
|--|-------------|--|-------|-------|-------|------|
| Speaker amplifier (continued) ( $R_L = 8 \Omega$ ) |             |  |       |       |       |      |
| R-ch. output noise voltage *2                      | $V_{NSR}$   | $R_g = 1 \text{ k}\Omega$<br>Pin 36: Open                              | —     | -80   | -70   | dBV  |
| Channel balance                                    | $CHB_S$     | $V_{IN} = -10 \text{ dBV}$<br>Pin 36: Open                             | -1    | 0     | 1     | dB   |
| L-ch. crosstalk *1                                 | $CT_{LSLR}$ | $V_{IN} = -10 \text{ dBV}$<br>Pin 36: Open                             | 70    | 80    | —     | dB   |
| R-ch. crosstalk *1                                 | $CT_{LSRL}$ | $V_{IN} = -10 \text{ dBV}$<br>Pin 36: Open                             | 70    | 80    | —     | dB   |
| L-ch. mute attenuation *1                          | $V_{MUSL}$  | $V_{IN} = -10 \text{ dBV}$<br>Pin 36: Open                             | 70    | 80    | —     | dB   |
| R-ch. mute attenuation *1                          | $V_{MUSR}$  | $V_{IN} = -10 \text{ dBV}$<br>Pin 36: Open                             | 70    | 80    | —     | dB   |
| Headphone amplifier ( $R_L = 32 \Omega$ )          |             |  |       |       |       |      |
| L-ch. output voltage level *1                      | $V_{HPL}$   | $V_{IN} = -10 \text{ dBV}$ , $R_L = 32 \Omega$                         | -8.4  | -5.0  | -2.5  | dBV  |
| R-ch. output voltage level *1                      | $V_{HPR}$   | $V_{IN} = -10 \text{ dBV}$ , $R_L = 32 \Omega$                         | -8.4  | -5.0  | -2.5  | dBV  |
| L-ch. total harmonic distortion *1                 | $TH_{HL}$   | $V_{OUT} = -14 \text{ dBV}$ , $R_L = 32 \Omega$                        | —     | 0.03  | 0.1   | %    |
| R-ch. total harmonic distortion *1                 | $TH_{HR}$   | $V_{OUT} = -14 \text{ dBV}$ , $R_L = 32 \Omega$                        | —     | 0.03  | 0.1   | %    |
| L-ch. max. output level *1                         | $V_{MAHL5}$ | THD = 1%, $R_L = 10 \text{ k}\Omega$                                   | 0.0   | —     | —     | dBV  |
| R-ch. max. output level *1                         | $V_{MAHR5}$ | THD = 1%, $R_L = 10 \text{ k}\Omega$                                   | 0.0   | —     | —     | dBV  |
| L-ch. output noise voltage *2                      | $V_{NHL}$   | $R_g = 1 \text{ k}\Omega$  | —     | -90   | -80   | dBV  |
| R-ch. output noise voltage *2                      | $V_{NHR}$   | $R_g = 1 \text{ k}\Omega$  | —     | -90   | -80   | dBV  |
| Channel balance                                    | $CHB_H$     | $V_{IN} = -10 \text{ dBV}$ , $R_L = 32 \Omega$                         | -2    | 0     | 2     | dB   |
| L-ch. crosstalk *1                                 | $CT_{LHLR}$ | $V_{IN} = -10 \text{ dBV}$ , $R_L = 32 \Omega$<br>$f = 10 \text{ kHz}$ | 60    | 70    | —     | dB   |
| R-ch. crosstalk *1                                 | $CT_{LHRL}$ | $V_{IN} = -10 \text{ dBV}$ , $R_L = 32 \Omega$<br>$f = 10 \text{ kHz}$ | 60    | 70    | —     | dB   |
| L-ch. mute attenuation *1                          | $V_{MUHL}$  | $V_{IN} = -10 \text{ dBV}$ , $R_L = 32 \Omega$                         | 70    | 80    | —     | dB   |
| R-ch. mute attenuation *1                          | $V_{MUHR}$  | $V_{IN} = -10 \text{ dBV}$ , $R_L = 32 \Omega$                         | 70    | 80    | —     | dB   |
| Volume   |             |  |       |       |       |      |
| L-ch. middle voltage gain *1                       | $VOL_L$     | $V_{IN} = -20 \text{ dBV}$ , $V_{ol} = 1/2 V_{CC}$                     | -34.5 | -32.0 | -29.5 | dBV  |
| R-ch. middle voltage gain *1                       | $VOL_R$     | $V_{IN} = -20 \text{ dBV}$ , $V_{ol} = 1/2 V_{CC}$                     | -34.5 | -32.0 | -29.5 | dBV  |
| Middle channel balance                             | $V_{CHB}$   | $V_{IN} = -20 \text{ dBV}$ , $V_{ol} = 1/2 V_{CC}$                     | -2    | 0     | 2     | dB   |
| L-ch. volume attenuation *1                        | $VOL_{NL}$  | $V_{IN} = -10 \text{ dBV}$ , $V_{ol} = 0 \text{ V}$                    | 70    | 80    | —     | dB   |
| R-ch. volume attenuation *1                        | $VOL_{NR}$  | $V_{IN} = -10 \text{ dBV}$ , $V_{ol} = 0 \text{ V}$                    | 70    | 80    | —     | dB   |

Note) \*1: DIN audio filter is used.

\*2: A-curve filter is used.

**■ Electrical Characteristics at  $f = 1$  kHz,  $V_{CC} = 5$  V,  $T_a = 25^\circ\text{C}$  (continue)**

| Parameter                          | Symbol      | Conditions  | Min  | Typ  | Max  | Unit |
|------------------------------------|-------------|---|------|------|------|------|
| <b>Line amplifier</b>              |             |   |      |      |      |      |
| L-ch. output voltage level *1      | $V_{HLL}$   | $V_{IN} = -10$ dBV, $R_L = 10$ k $\Omega$                 | -6.0 | -4.0 | -2.0 | dBV  |
| R-ch. output voltage level *1      | $V_{HLR}$   | $V_{IN} = -10$ dBV, $R_L = 10$ k $\Omega$                 | -6.0 | -4.0 | -2.0 | dBV  |
| L-ch. total harmonic distortion *1 | $TH_{LL}$   | $V_{IN} = -10$ dBV, $R_L = 10$ k $\Omega$                 | —    | 0.01 | 0.03 | %    |
| R-ch. total harmonic distortion *1 | $TH_{LR}$   | $V_{IN} = -10$ dBV, $R_L = 10$ k $\Omega$                 | —    | 0.01 | 0.03 | %    |
| L-ch. max. output level *1         | $V_{MALL5}$ | THD = 1%, $R_L = 10$ k $\Omega$                           | 0.0  | —    | —    | dBV  |
| R-ch. max. output level *1         | $V_{MALR5}$ | THD = 1%, $R_L = 10$ k $\Omega$                           | 0.0  | —    | —    | dBV  |
| L-ch. output noise voltage *2      | $V_{NLL}$   | $R_g = 1$ k $\Omega$                                      | —    | -100 | -90  | dBV  |
| R-ch. output noise voltage *2      | $V_{NLR}$   | $R_g = 1$ k $\Omega$                                      | —    | -100 | -90  | dBV  |
| Channel balance                    | $CHB_L$     | $V_{IN} = -10$ dBV, $R_L = 10$ k $\Omega$                 | -1   | 0    | 1    | dB   |
| L-ch. crosstalk *1                 | $CT_{LLLR}$ | $V_{IN} = -10$ dBV, $R_L = 10$ k $\Omega$<br>$f = 10$ kHz | 60   | 70   | —    | dB   |
| R-ch. crosstalk *1                 | $CT_{LLRL}$ | $V_{IN} = -10$ dBV, $R_L = 10$ k $\Omega$<br>$f = 10$ kHz | 60   | 70   | —    | dB   |
| L-ch. mute attenuation *1          | $V_{MUHL}$  | $V_{IN} = -10$ dBV, $R_L = 10$ k $\Omega$                 | 70   | 80   | —    | dB   |
| R-ch. mute attenuation *1          | $V_{MUHR}$  | $V_{IN} = -10$ dBV, $R_L = 10$ k $\Omega$                 | 70   | 80   | —    | dB   |
| <b>Switching level</b>             |             |   |      |      |      |      |
| HP mute on                         | $HMU_{ON}$  |   | GND  | —    | 0.8  | V    |
| HP mute off                        | $HMU_{OF}$  |   | 2.0  | —    | 5.5  | V    |
| HP standby on                      | $HST_{ON}$  |   | GND  | —    | 0.8  | V    |
| HP standby off                     | $HST_{OF}$  |   | 2.0  | —    | 5.5  | V    |
| SP mute on                         | $SMU_{ON}$  |   | GND  | —    | 0.8  | V    |
| SP mute off                        | $SMU_{OF}$  |   | 2.0  | —    | 5.5  | V    |
| SP standby on                      | $SST_{ON}$  |   | GND  | —    | 0.8  | V    |
| SP standby off                     | $SST_{OF}$  |   | 2.0  | —    | 5.5  | V    |
| Bass boost off                     | $BAS_{OF}$  |   | GND  | —    | 0.8  | V    |
| Bass boost on                      | $BAS_{ON}$  |   | 2.0  | —    | 5.5  | V    |
| Line mute on                       | $LMU_{ON}$  |   | GND  | —    | 0.8  | V    |
| Line mute off                      | $LMU_{OF}$  |   | 2.0  | —    | 5.5  | V    |

Note) \*1: DIN audio filter is used.

\*2: A-curve filter is used.

## ■ Electrical Characteristics at $f = 1 \text{ kHz}$ , $V_{CC} = 5 \text{ V}$ , $T_a = 25^\circ\text{C}$ (continue)

### • Design reference data

Note) The characteristics listed below are theoretical values based on the IC design and are not guaranteed.

| Parameter  | Symbol             | Conditions                                      | Min  | Typ | Max | Unit |
|--|--------------------|---|------|-----|-----|------|
| L-ch. ripple rejection<br>(Speaker amplifier) *1   | RJ <sub>SPL</sub>  | $f_r = 1 \text{ kHz}$ , $V_r = -20 \text{ dBV}$ | —    | 60  | —   | dB   |
| R-ch. ripple rejection<br>(Speaker amplifier) *1   | RJ <sub>SPR</sub>  | $f_r = 1 \text{ kHz}$ , $V_r = -20 \text{ dBV}$ | —    | 60  | —   | dB   |
| L-ch. ripple rejection<br>(Headphone amplifier) *1 | RJ <sub>HPL</sub>  | $f_r = 1 \text{ kHz}$ , $V_r = -20 \text{ dBV}$ | —    | 60  | —   | dB   |
| R-ch. ripple rejection<br>(Headphone amplifier) *1 | RJ <sub>HPR</sub>  | $f_r = 1 \text{ kHz}$ , $V_r = -20 \text{ dBV}$ | —    | 60  | —   | dB   |
| L-ch. ripple rejection<br>(Line amplifier) *1      | RJ <sub>LIL</sub>  | $f_r = 1 \text{ kHz}$ , $V_r = -20 \text{ dBV}$ | —    | 60  | —   | dB   |
| R-ch. ripple rejection<br>(Line amplifier) *1      | RJ <sub>LIR</sub>  | $f_r = 1 \text{ kHz}$ , $V_r = -20 \text{ dBV}$ | —    | 60  | —   | dB   |
| L-ch. output offset voltage                        | $V_{\text{OFSL}}$  | $R_g = 0 \ \Omega$                              | -100 | 0   | 100 | mV   |
| R-ch. output offset voltage                        | $V_{\text{OFSR}}$  | $R_g = 0 \ \Omega$                              | -100 | 0   | 100 | mV   |
| L-ch. max. output power 2 *1                       | $V_{\text{MAXSL}}$ | THD = 10%<br>Pin 36: Open                       | —    | 1   | —   | W    |
| R-ch. max. output power 2 *1                       | $V_{\text{MAXSR}}$ | THD = 10%<br>Pin 36: Open                       | —    | 1   | —   | W    |

Note) \*1: DIN audio filter is used.

## ■ Terminal Equivalent Circuits

| Pin No. | Equivalent circuit | Description   | Voltage |
|---------|--------------------|---|---------|
| 1       | —                  | VCCRSP:<br>R-ch. speaker amplifier power supply pin | 5 V     |
| 2       |                    | SPOR1:<br>R-ch. speaker amplifier output pin 1      | 2.3 V   |
| 3       |                    | SPOR2:<br>R-ch. speaker amplifier output pin 2      | 2.3 V   |

■ Terminal Equivalent Circuits (continue)

| Pin No. | Equivalent circuit | Description   | Voltage |
|---------|--------------------|---|---------|
| 4       | —                  | N.C.  | —       |
| 5       | —                  | GNDRSP:<br>Ground pin for the power of R-ch.<br>speaker amplifier                                   | 0 V     |
| 6       |                    | BASSC1:<br>Pin for the capacitor 1 connected to<br>the LPF output at the 1st stage of bass<br>boost | 2.3 V   |
| 7       |                    | SPINR:<br>Speaker amplifier R-ch. input pin   | 2.3 V   |
| 8       |                    | SPINL:<br>Speaker amplifier L-ch. input pin   | 2.3 V   |



### ■ Terminal Equivalent Circuits (continue)

| Pin No. | Equivalent circuit | Description   | Voltage |
|---------|--------------------|---|---------|
| 9       |                    | RFSP:<br>Speaker amplifier ripple filter pin                        | 2.8 V   |
| 10      | —                  | VCCSSP:<br>Speaker amplifier small signal power supply pin          | 5 V     |
| 11      |                    | HPOL:<br>L-ch. headphone amplifier output pin                       | 2.15 V  |
| 12      |                    | HPOR:<br>R-ch. headphone amplifier output pin                       | 2.15 V  |
| 13      | —                  | GNDPHP:<br>Ground pin for the power of head-<br>phone amplifier     | 0 V     |
| 14      | —                  | GNDSHP:<br>Ground pin for the headphone ampli-<br>fier small signal | 0 V     |
| 15      | —                  | N.C.  | —       |
| 16      | —                  | VCCPHP:<br>Headphone amplifier power supply<br>pin                  | 5 V     |
| 17      | —                  | VCCSHP:<br>Headphone amplifier small signal<br>power supply pin     | 5 V     |

### ■ Terminal Equivalent Circuits (continue)

| Pin No. | Equivalent circuit | Description   | Voltage |
|---------|--------------------|---|---------|
| 18      | —                  | N.C.  | —       |
| 19      | —                  | N.C.  | —       |
| 20      | —                  | N.C.  | —       |
| 21      | —                  | N.C.  | —       |
| 22      |                    | BEEPIN:<br>Beep input pin                           | 1.0 V   |
| 23      | —                  | N.C.  | —       |
| 24      |                    | HPINR2:<br>Headphone amplifier R-ch. input<br>pin 2 | 1.4 V   |
| 25      |                    | HPINL1:<br>Headphone amplifier L-ch. input<br>pin 1 | 1.4 V   |
| 26      | —                  | N.C.  | —       |
| 27      |                    | LINEINL:<br>Line amplifier L-ch. input pin          | 2.5 V   |

■ Terminal Equivalent Circuits (continue)

| Pin No. | Equivalent circuit | Description                                       | Voltage |
|---------|--------------------|---|---------|
| 28      |                    | LINEINR:<br>Line amplifier R-ch. input pin        | 2.5 V   |
| 29      |                    | LINEOUTR:<br>Line amplifier R-ch. output pin      | 2.15 V  |
| 30      | —                  | LINEGND:<br>Ground pin for line amplifier         | 0 V     |
| 31      |                    | LINEOUTL:<br>Line amplifier L-ch. output pin      | 2.15 V  |
| 32      |                    | BEEPCL:<br>Line amplifier beep output control pin | 0.1 V   |

### ■ Terminal Equivalent Circuits (continue)

| Pin No. | Equivalent circuit | Description   | Voltage |
|---------|--------------------|---|---------|
| 33      |                    | <b>LINEMU:</b><br>Line amplifier mute control pin             | —       |
| 34      |                    | <b>BEEPCH:</b><br>Headphone amplifier beep output control pin | 0.1 V   |
| 35      |                    | <b>MUTEHP:</b><br>Headphone amplifier mute control pin        | —       |
| 36      |                    | <b>SPPWSW:</b><br>Speaker power selector pin                  | —       |

■ Terminal Equivalent Circuits (continue)

| Pin No. | Equivalent circuit | Description   | Voltage |
|---------|--------------------|---|---------|
| 37      |                    | <b>RFHP:</b><br>Headphone amplifier ripple filter pin               | 4.9 V   |
| 38      | —                  | <b>GNDSSP:</b><br>Ground pin for the speaker amplifier small signal | 0 V     |
| 39      |                    | <b>VOLC:</b><br>Volume control pin                                  | —       |
| 40      |                    | <b>RFLINE:</b><br>Line amplifier ripple filter pin                  | 4.9 V   |
| 41      |                    | <b>STAHPLI:</b><br>Headphone amplifier/line amplifier standby pin   | —       |
| 42      | —                  | N.C.  | —       |

■ Terminal Equivalent Circuits (continue)

| Pin No. | Equivalent circuit | Description   | Voltage |
|---------|--------------------|---|---------|
| 43      |                    | MUTESP:<br>Speaker amplifier mute control pin   | —       |
| 44      |                    | STASP:<br>Speaker amplifier standby pin   | —       |
| 45, 46  |                    | BASSR1, BASSR2:<br>Bass boost gain setting pins   | 2.3 V   |
| 47      |                    | BASSC2:<br>Pin for the capacitor 2 connected to the LFP output at the 2nd stage of bass boost | 2.3 V   |
| 48, 49  |                    | BASSD1, BASSD2:<br>Bass boost capacitor connection pins                                       | 2.3 V   |

■ Terminal Equivalent Circuits (continue)

| Pin No. | Equivalent circuit | Description   | Voltage |
|---------|--------------------|---|---------|
| 50      |                    | <b>BASSAGC:</b><br>Bass boost AGC pin                                 | —       |
| 51      |                    | <b>BASSSW:</b><br>Bass boost on/off switch pin                        | —       |
| 52      | —                  | <b>GNDLSP:</b><br>Ground pin for the power of L-ch. speaker amplifier | 0 V     |
| 53      | —                  | N.C.  | —       |
| 54      |                    | <b>SPOL1:</b><br>L-ch. speaker amplifier output pin 2                 | 2.3 V   |
| 55      |                    | <b>SPOL2 :</b><br>L-ch. speaker amplifier output pin 1                | 2.3 V   |
| 56      | —                  | <b>VCCLSP:</b><br>L-ch. speaker amplifier power supply pin            | 5 V     |

## ■ Application Notes

### 1. Pin descriptions

- Pin 1 (power supply for R-ch. speaker power use)  
Please put a capacitor of about 47  $\mu\text{F}$  between pin 1 and pin 5.
- Pin 2, pin 3 (R-ch. speaker output) (BTL out)
- Pin 4 (N.C.)
- Pin 5 (GND for R-ch. speaker power use)
- Pin 6, pin 45, pin 46, pin 47, pin 48, pin 49 (bass boost)  
Following equivalent circuit is for bass boost.

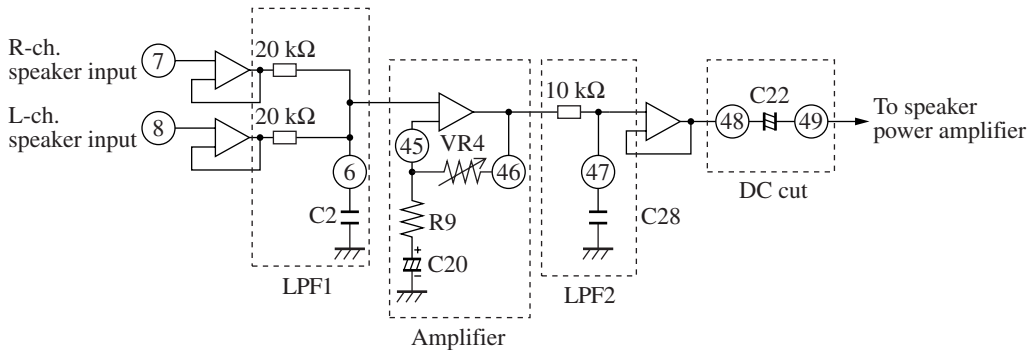

#### 1) Pin 6

This pin makes first LPF together with internal registers.  
When a value of C2 is 0.033  $\mu\text{F}$ , cutoff frequency is 500 Hz.

#### 2) Pin 45, pin 46

This gain is

$$G_v = \frac{VR4 + R9}{R9}$$

It is necessary that  $VR4 = 3.9 \text{ k}\Omega$ ,  $R9 = 1 \text{ k}\Omega$  for amplifier gain of five times.  
The HPF is composed with R9 and C20, then if R9 is 1  $\text{k}\Omega$ , suitable value of C20 is 3.3  $\mu\text{F}$ .

#### 3) Pin 47

This pin makes second LPF together with internal registers.  
When a value of C21 is 0.033  $\mu\text{F}$ , cutoff frequency is 500 Hz.

#### 4) Pin 48, pin 49

This purpose is DC cut. Suitable value of C22 is 10  $\mu\text{F}$  (bipolar), because input impedance of speaker power amplifier is 2  $\text{k}\Omega$ .

- Pin 7, pin 8 (L-ch., R-ch. speaker input)

If no resistors are connected to pin 7 and pin 8 from previous stage, the BTL output has the gain of 40 times.  
If input of 1.4/40 V[rms] or more is possibly inputted, the input should be attenuated by connecting resistors to pin 7 and pin 8 from previous stage because the output dynamic range is about 1.4 V[rms].

The gain at BTL output is  $2 \text{ k}\Omega / (R1 + 2 \text{ k}\Omega) \times 40$ , where R1 and R2 are the resistance of resistors of connected to pin 7 and pin 8 from the previous stage and  $R1 = R2$ .

Supposing that max output level of headphone is 1 V[rms], suitable value of R1 and R2 is 25  $\text{k}\Omega$ , because gain of speaker power amplifier is 32 dB.

- Pin 9 (ripple filter of speaker amplifier)

Recommended value is 1  $\mu\text{F}$ .

If capacitor value is bigger, rise time at standby is longer.

If capacitor value is smaller, rise time at stanby is shorter, but there are possibilities of pop sound occurrence and deterioration of power supply ripple rejection, cross talk and THD.



## ■ Application Notes (continue)

### 1. Pin descriptions (continue)

- Pin 10 (power supply (speaker small signal use))  
Please put a capacitor of 33  $\mu\text{F}$  between GND (pin 38) and pin 10.
- Pin 11, pin 12 (L-ch., R-ch. headphone output)  
In consideration of headphone load, suitable value of C5, C6 is 220  $\mu\text{F}$ .
- Pin 13 (GND (headphone power use))
- Pin 14 (GND (headphone small signal use))
- Pin 15 (N.C.)  
Pin 15 connects to IC's heat sink.
- Pin 16 (power supply (headphone power use))  
Please put an about 47  $\mu\text{F}$  capacitor between pin 13 and pin 14.
- Pin 17 (power supply (headphone small signal use))  
Please put an about 47  $\mu\text{F}$  capacitor between pin 13 and pin 14.
- Pin 18, Pin 19, Pin 20, Pin 21 (N.C.)
- Pin 22 (beep input)  
The beep output at head phone (HP) output is  $0.864 \times 10 \text{ k}\Omega / (1 \text{ k}\Omega + R1)$  [Vp-p], where R1 is the resistance of the resistor between pin 34 and GND.  
Suitable value of R3 is 25  $\text{k}\Omega$  and suitable value of C8 is 1  $\mu\text{F}$ .
- Pin 23 (N.C.)
- Pin 24, Pin 25 (headphone amplifier L-ch., R-ch. input)  
Suitable value of C9, C10 is 1  $\mu\text{F}$ , because input impedance of headphone power amplifier is 20  $\text{k}\Omega$ .  
If no resistors are connected to pin 24 and pin 25 from previous stage, the headphone amplifier has the gain of about 13 dB (at maximum volume). If input of 1.1/5 V[rms] or more is possibly inputted, the input should be attenuated by connecting resistors to pin 24 and pin 25 from previous stage because the output dynamic range is about 1.1 V[rms].  
The gain is  $20 \text{ k}\Omega / (R4 + 20 \text{ k}\Omega) \times 4.5$ , where R4 and R5 are the resistance of resistors connected to pin 24 and pin 25 from the previous stage and  $R4 = R5$ .
- Pin 26 (N.C.)
- Pin 27, Pin 28 (line amplifier L-ch., R-ch. input)  
Suitable value of C11, C12 is 1  $\mu\text{F}$ , because input impedance of line amplifier is 50  $\text{k}\Omega$ .  
If no resistors are connected to pin 27 and pin 28 from previous stage, the line amplifier has the fixed gain of about 6 dB. If input of 1.1/2 V[rms] or more is possibly inputted, the input should be attenuated by connecting resistors to pin 27 and pin 28 from previous stage because the output dynamic range is about 1.1 V[rms].  
The gain is  $50 \text{ k}\Omega / (RX + 50 \text{ k}\Omega) \times 2$ , where RXs are the resistance of resistors connected to pin 27 and pin 28 from the previous stage.
- Pin 29 (line amplifier R-ch. output)  
Suitable value of C13 is 1  $\mu\text{F}$ .
- Pin 30 (GND (line amplifier))
- Pin 31 (line amplifier L-ch. output)  
Suitable value of C14 is 1  $\mu\text{F}$ .
- Pin 32 (beep control (line amplifier))  
A value of VR1 is bigger, output level is smaller.  
Around 10  $\text{k}\Omega$  is suitable as the maximum value for VR1. The beep output at line output is  $0.9 \times 10 \text{ k}\Omega / (1 \text{ k}\Omega + VR1)$  V[p-p], where VR1 is the resistance of the resistor between pin 34 and GND.
- Pin 33 (line amplifier mute control)  
Suitable value of R6 is 75  $\text{k}\Omega$  and suitable value of C15 is 0.68  $\mu\text{F}$ .  
Rise time is about 20 ms.  
If value of R and C is smaller, switching time is shorter but there is a possibility of pop sound occurrence.

**■ Application Notes (continue)**

## 1. Pin descriptions (continue)

- Pin 34 (beep control (headphone amplifier))

A value of VR2 is bigger, output level is smaller.  
Around 10 k $\Omega$  is suitable as the maximum value for VR2. The beep output at the headphone output is  $0.864 \times 10 \text{ k}\Omega / (1 \text{ k}\Omega + \text{VR2}) \text{ V}_{[\text{p-p}]}$ , where VR2 is the resistance of the resistor between pin 34 and GND.
- Pin 35 (headphone amplifier mute control)

Suitable value of R7 is 75 k $\Omega$  and suitable value of C16 is 0.68  $\mu\text{F}$ .  
Rise time is about 20 ms.  
If value of R and C is smaller, switching time is shorter but there is a possibility of pop sound occurrence.
- Pin 36 (Speaker power selector)

If this pin is left open, output power of 1 W or more is possible.  
If this pin is short-circuited to GND, the output power is limited to 0.5 W.
- Pin 37 (ripple filter (headphone))

A recommended value is 4.7  $\mu\text{F}$ .  
If capacitor value is bigger, rise time at standby is longer.  
If capacitor value is smaller, rise time at standby is shorter, but there are possibilities of pop sound occurrence and deteriorations of power supply ripple rejection and cross talk and THD.
- Pin 38 (GND (speaker small signal use))
- Pin 39 (volume control)

Please put a variable volume of 50 k $\Omega$  or more between headphone  $V_{\text{CC}}$  and headphone GND.
- Pin 40 (ripple filter (line amplifier))

A recommended value is 4.7  $\mu\text{F}$ .  
If capacitor value is bigger, rise time at standby is longer.  
If capacitor value is smaller, rise time at standby is shorter, but there are possibilities of pop sound occurrence and deteriorations of power supply ripple rejection and cross talk and THD.
- Pin 41 (standby (line amplifier, headphone amplifier))

Switching time depends on value of pin 37 and pin 40 capacitors.
- Pin 42 (N.C.)

Pin 42 connects to IC's heat sink.

  - 1) Case of not using bass boost

Please open pin 6, pin 47, pin 48, pin 49 and pin 50.  
Please connect pin 51 to GND.  
Please short between pin 45 and pin 46.
  - 2) Case of not using line amplifier  
Please open pin 27, pin 28, pin 29, pin 31 and pin 32.  
Please connect pin 33 to GND.
- Pin 43 (speaker mute control)

Suitable value of R8 is 75 k $\Omega$ , suitable value of C19 is 0.68  $\mu\text{F}$ .  
Rise time is about 20 ms.  
If value of R and C is smaller, switching time is shorter, but there is a possibility of pop sound occurrence.
- Pin 44 (standby (speaker))

Switching time depends on value of pin 9 capacitor.  
If value of C3 is 1  $\mu\text{F}$ , rise time is about 80 ms.

## ■ Application Notes (continue)

### 1. Pin descriptions (continue)

- Pin 45, pin 46, pin 47, pin 48, pin 49  
Refer to pin 6.
- Pin50 (bass boost AGC)  
Connect this pin to GND with a resistor of 220 k $\Omega$  connected in parallel with a capacitor of 4.7  $\mu$ F.
- Pin 51 (bass boost on/off switch)  
Suitable value of R11 is 75 k $\Omega$  and suitable value of C24 is 0.68  $\mu$ F.  
Rise time is about 20 ms.  
If value of R and C is smaller, switching time is shorter but there is a possibility of pop sound occurrence.
- Pin 52 (GND (L-ch. speaker power use))
- Pin 53 (N.C.)
- Pin 54, pin 55 (L-ch. speaker output) (BTL out)
- Pin 56 (power supply (L-ch. speaker power use))  
Please put an about 47  $\mu$ F capacitor between pin 56 and pin 52.

## ■ Technical Data

### 1. $P_D$ — $T_a$ curves of HSOP056-P-0300A

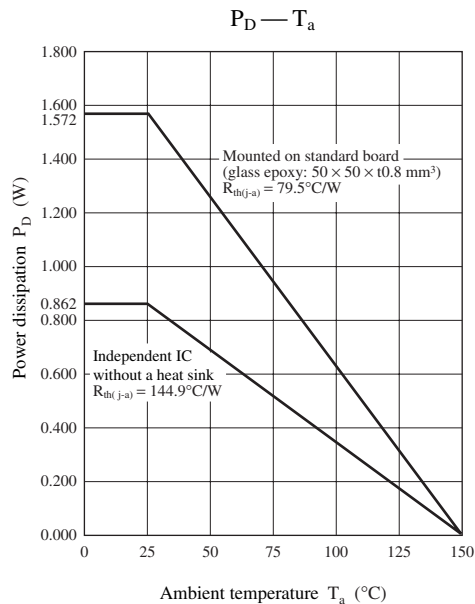

■ Technical Data (continued)

2. Main characteristics

1) SP amplifier

(1) 0.5 W mode

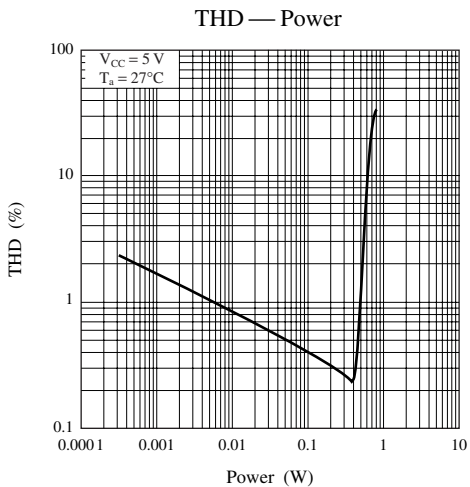
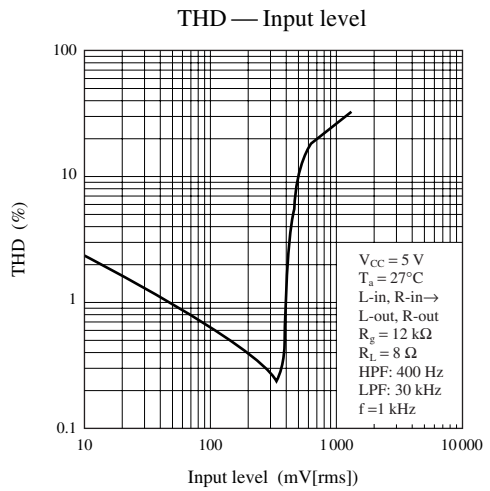
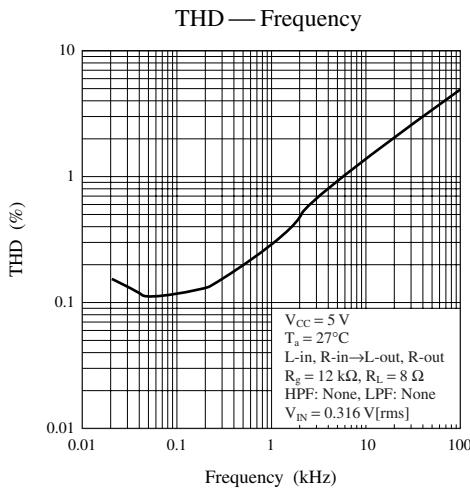
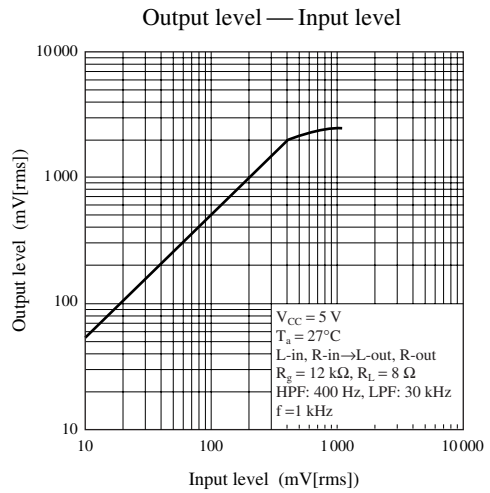
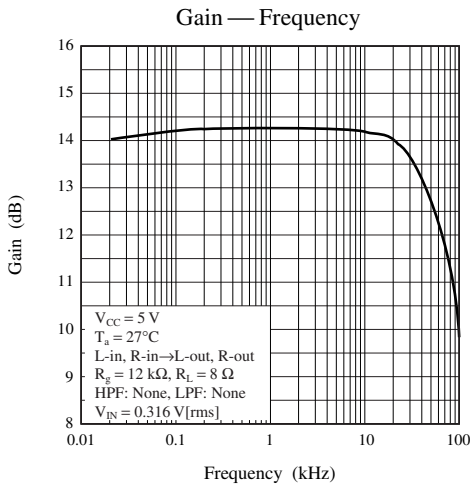

■ Technical Data (continued)

2. Main characteristics (continued)

1) SP amplifier (continued)

(2) 1 W mode

Gain — Frequency

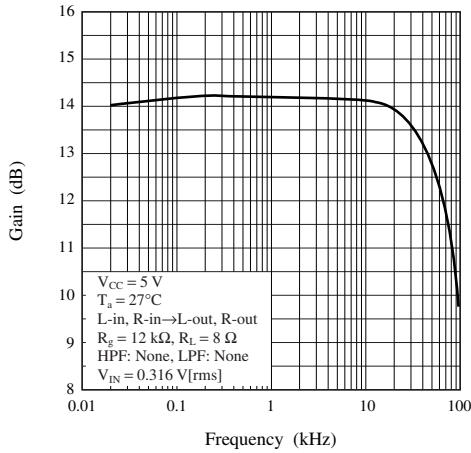

Output level — Input level

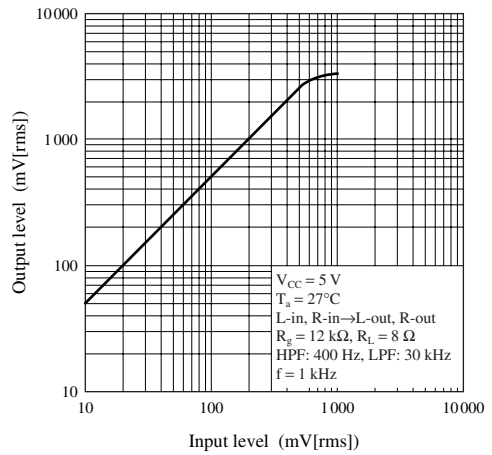

THD — Frequency

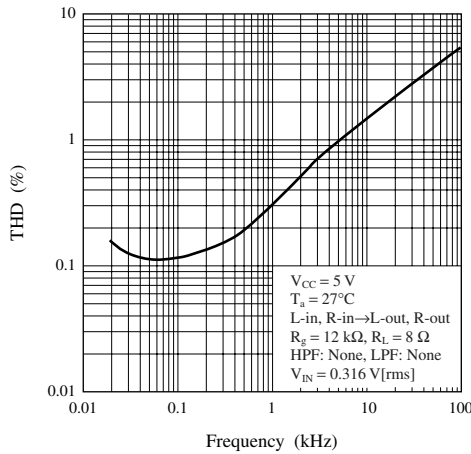

THD — Input level

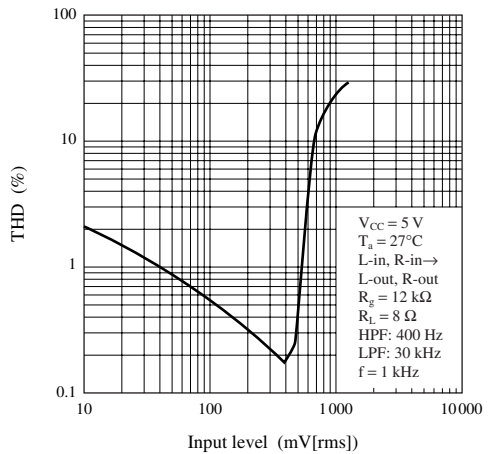

THD — Power

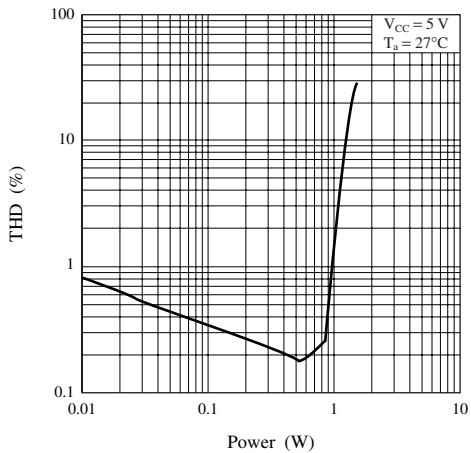

■ Technical Data (continued)

2. Main characteristics (continued)

2) HP amplifier

(1)  $V_{CC} = 5\text{ V}$ ,  $T_a = 25^\circ\text{C}$

Gain — Frequency

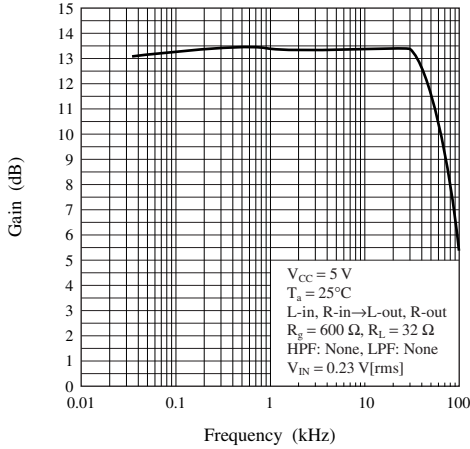

Output level — Input level

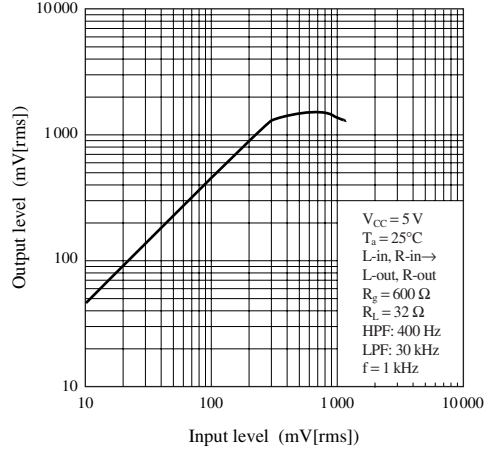

THD — Frequency

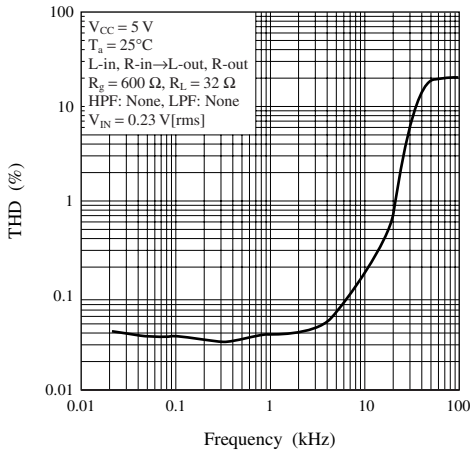

THD — Input level

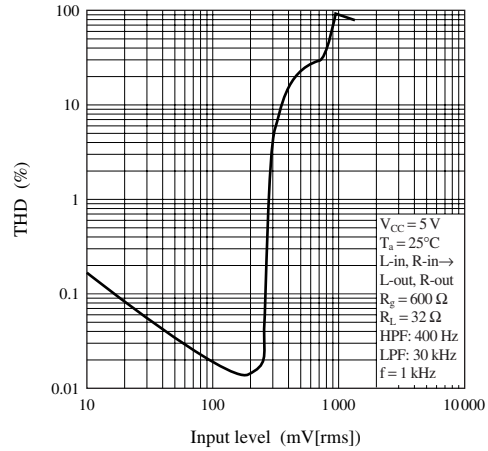

(2)  $V_{CC} = 5\text{ V}$ ,  $T_a = 27^\circ\text{C}$

Output level — Input level

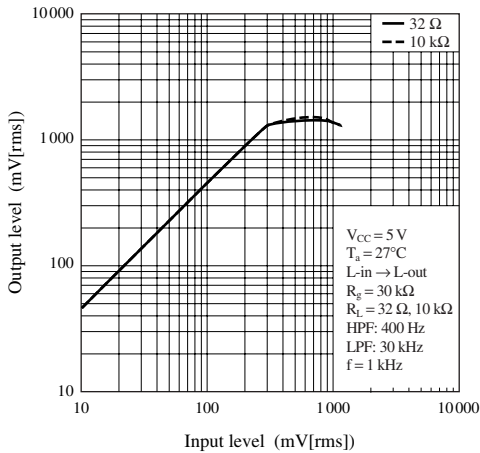

THD — Input level

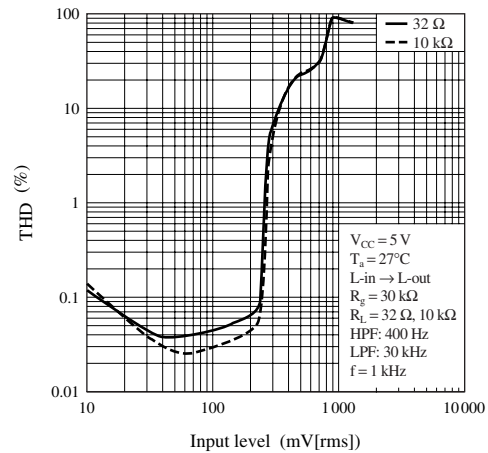

■ Technical Data (continued)

2. Main characteristics (continued)

3) Line amplifier

(1)  $V_{CC} = 5\text{ V}$ ,  $T_a = 27^\circ\text{C}$

Gain — Frequency

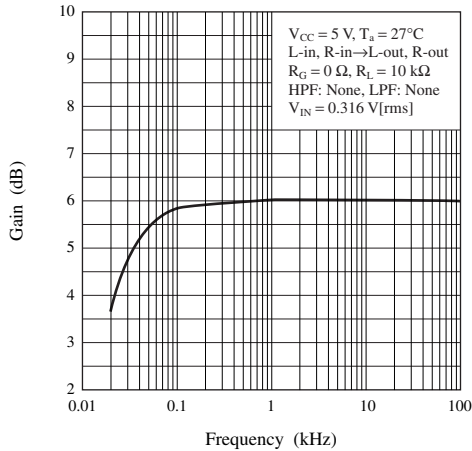

Output level — Input level

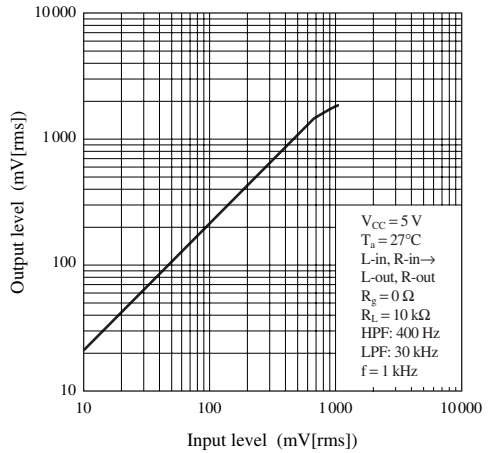

THD — Frequency

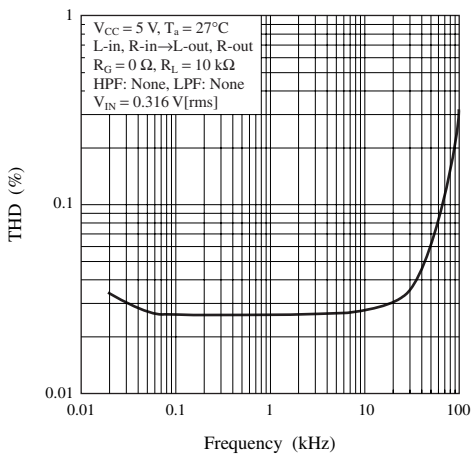

THD — Input level

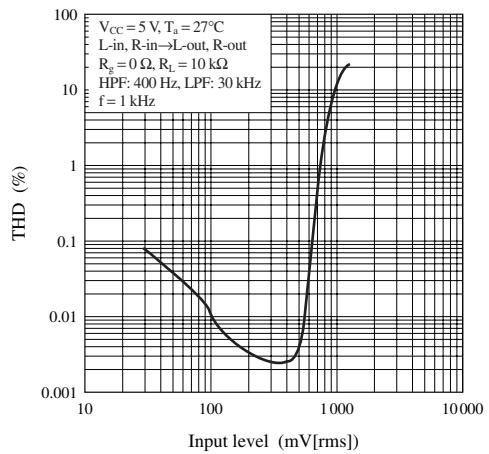

**■ Usage Notes**

1.
  - 1) Make sure that the IC is free of output- $V_{CC}$  short, output-GND short and load short.
  - 2) The thermal protection circuit operates at a  $T_j$  of approximately 150°C. The thermal protection circuit is reset automatically when the temperature drops.
  - 3) Beep in pin should not be down lower than  $-0.3$  V.
  - 4) The IC should not be inserted in reverse.
2. The IC has the possibility of break-down as follows.
  - 1) Reverse connection of the  $V_{CC}$  and GND pins.
  - 2) The power supply connection to output-pins (pin 55, pin 54, pin 2 and pin 3), when  $V_{CC}$  and GND are opened.
  - 3) Output-GND short, when GND pin is opened.
  - 4) Output pins (pin 55, pin 54, pin 2 and pin 3) short to GND.
  - 5) Output pins (pin 55, pin 54, pin 2 and pin 3) short to  $V_{CC}$ .
  - 6) Short between outputs.
  - 7) Reverse insertion.



## Request for your special attention and precautions in using the technical information and semiconductors described in this material

- (1) An export permit needs to be obtained from the competent authorities of the Japanese Government if any of the products or technologies described in this material and controlled under the "Foreign Exchange and Foreign Trade Law" is to be exported or taken out of Japan.
- (2) The technical information described in this material is limited to showing representative characteristics and applied circuit examples of the products. It does not constitute the warranting of industrial property, the granting of relative rights, or the granting of any license.
- (3) The products described in this material are intended to be used for standard applications or general electronic equipment (such as office equipment, communications equipment, measuring instruments and household appliances).  
Consult our sales staff in advance for information on the following applications:
  - Special applications (such as for airplanes, aerospace, automobiles, traffic control equipment, combustion equipment, life support systems and safety devices) in which exceptional quality and reliability are required, or if the failure or malfunction of the products may directly jeopardize life or harm the human body.
  - Any applications other than the standard applications intended.
- (4) The products and product specifications described in this material are subject to change without notice for reasons of modification and/or improvement. At the final stage of your design, purchasing, or use of the products, therefore, ask for the most up-to-date Product Standards in advance to make sure that the latest specifications satisfy your requirements.
- (5) When designing your equipment, comply with the guaranteed values, in particular those of maximum rating, the range of operating power supply voltage and heat radiation characteristics. Otherwise, we will not be liable for any defect which may arise later in your equipment.  
Even when the products are used within the guaranteed values, redundant design is recommended, so that such equipment may not violate relevant laws or regulations because of the function of our products.
- (6) When using products for which dry packing is required, observe the conditions (including shelf life and after-unpacking standby time) agreed upon when specification sheets are individually exchanged.
- (7) No part of this material may be reprinted or reproduced by any means without written permission from our company.

## Please read the following notes before using the datasheets

- A. These materials are intended as a reference to assist customers with the selection of Panasonic semiconductor products best suited to their applications.  
Due to modification or other reasons, any information contained in this material, such as available product types, technical data, and so on, is subject to change without notice.  
Customers are advised to contact our semiconductor sales office and obtain the latest information before starting precise technical research and/or purchasing activities.
- B. Panasonic is endeavoring to continually improve the quality and reliability of these materials but there is always the possibility that further rectifications will be required in the future. Therefore, Panasonic will not assume any liability for any damages arising from any errors etc. that may appear in this material.
- C. These materials are solely intended for a customer's individual use.  
Therefore, without the prior written approval of Panasonic, any other use such as reproducing, selling, or distributing this material to a third party, via the Internet or in any other way, is prohibited.