

A3

Switches & Pilot Devices



TW NEMA Style Switches with snap-on contacts

Key features include:

- Corrosion resistant octagonal chrome plated locking bezel
- Snap-on 10A contact blocks
- Transformer or full voltage
- Incandescent or LED illumination
- Slow make, double break, self cleaning contacts
- Modular construction for maximum flexibility
- NEMA 4X and IP65 watertight/oiltight panel
- Available assembled or as sub-components
- Large M3.5 screw terminals with captive sems plate

IDEC has your 22mm switching needs covered.

Button styles include flush, extended, mushroom, or square and all bodies are crafted from fracture-resistant nylon.

All illuminated units feature two lense styles, one that maximizes light dispersion, the other accommodates direct lense engraving.

Self cleaning contact mechanisms allow for a wide current rating, 5mA to 10A, which reduces the need for various contact materials.

When looking for a 22mm switch that is durable, easy to use, and versatile, then IDEC's TW series is your solution.



UL Listed
File No. E70646



File No. 9561116E01







CSA Certified
File No. LR48366



File No. DK95-01696



Certificate No.
2030010305027380

Conforming to Standards		EN60947-1, EN60947-5-1, VDE0660-200, UL508, CSA C22-2 No.14							
Approvals		<div style="display: flex; justify-content: space-around; align-items: flex-start;"> <div style="text-align: center;">  File No. E68961 </div> <div style="text-align: center;">  File No. LR21451 </div> <div style="text-align: center;">  Certificate No. 2030010305027380 </div> </div> <div style="display: flex; justify-content: space-around; align-items: flex-start; margin-top: 10px;"> <div style="text-align: center;">  TÜV Rheinland Registration No: J9551802 (E-Stops) Registration No: J9551803 (All other switches) Registration No: J9551804 (Pilot Lights) </div> <div style="text-align: center;">  </div> </div> <p>CSA: pushbuttons and selector switches: A600 pilot lights and illuminated pushbuttons, direct supply pilot lights and illuminated pushbuttons with integral transformer (100/110, 115, 120, 200/220, 230, 240, 380, 400/440, 480V) UL: pushbuttons and selector switches: A600 pilot lights and illuminated pushbuttons, direct supply pilot lights and illuminated pushbuttons with integral transformer (100/110, 115, 120, 200/220, 230, 240, 380, 400/440, 480V) TÜV: pushbuttons and selector switches: A600=P600 (NO, NC)/Q600 (NO-EM, NC-LB) pilot lights and illuminated pushbuttons, direct supply pilot lights and illuminated pushbuttons with integral transformer (100/110, 115, 120, 200/220, 230, 240, 380, 400/440, 480V)</p>							
Operating Temperature		Operation: -25 to +50°C (without freezing) Storage: -40 to +80°C (without freezing)							
Vibration Resistance		5 to 55Hz, 100m/sec ² (10g) conforming to IEC6068-2-6							
Shock Resistance		1000m/sec ² (100g) conforming to IEC6068-2-7							
Electric Shock Protection		Class 0 conforming to IEC60536							
Degree of Protection (conforming to IEC60529) (conforming to NEMA ICS6-110)		IP65 from front of the panel; (IP54 for key switches) IP20 (Type HW-F contact block) NEMA 1, 2, 3, 3R, 3S, 4, 4X, 5, 12, 13 (NEMA 1, 2, 3R, 5, 12, 13 for key switches)							
Mechanical Life		Momentary pushbuttons: 5,000,000 (900 operations per hour) All other switches: 500,000							
Pollution Degree (conforming to IEC60947-1)		3 for switches not using a transformer 2 for switches using a transformer							
Rated Operational Characteristics		AC-15: A600 or Ue = 250V, Ie = 3A (NO, NC, NO-EM, NC-LB) DC-13: P600 or Ue = 125V, Ie = 1.1A (NO, NC) DC-13: Q600 or Ue = 125V, Ie = 0.9A (NO-EM, NC-LB)							
Rated Insulation Voltage		600V							
Rated Switching Over-Voltage		Less than 4kV, conforming to IEC60947-1							
Rated Impulse Withstanding Voltage		4kV for contact circuit 2.5kV for lamp circuit							
Rated Thermal Current		10 Amp							
Minimum Switching Capacity		5 mA at 3V AC/DC							
Contact Operation		Slow break NC or slow make NO, self-cleaning							
Recommended Terminal Torque		0.8 N m (7.1 in lb.)							
External Short-Circuit Protection		10A 250V fuse conforming to IEC60269-1							
Applicable Wire Size		Minimum 1 x 22 AWG, max. 2 x 14 AWG or 1 x 12 AWG							
Contact Resistance		Initial contact resistance of 50mΩ or less							
Contact Gap		4mm (NO and NC) 2mm (NO-EM and NC-LB)							
Electrical Reliability		MTBF < 1 fault for 10 million operation cycles (3V DC, 5mA)							
Lamp Ratings		Incandescent: 1 W LEDs: 6V: 17mA max, 12/24V: 11mA max, 120/240V: 10mA max							
Horsepower Rating		1/4 HP @ 120V (single-phase, non-reversing motor); 1 HP @ 240V (3 phase, non-reversing motor)							
Maximum Inrush Current		40 A (40 ms)							
Contact Material		Silver							
Contact Ratings	Pushbuttons Illuminated Pushbuttons Selector Switches Illuminated Selector Switches Pushbutton Selectors		Contact Block			Type HW-C/HW-F			
			Rated Insulation Voltage			600V			
			Rated Continuous Current			10A			
			Contact Ratings by Utilization Category IEC 60947-5-1			AC-15 (A600) DC-13 (P600)			
Characteristics	Contact Ratings by Utilization Category								
	Operational Voltage			24V	48V	50V	110V	220V	440V
	Operational Current	AC 50/60 Hz	AC-12 Control of resistive loads & solid state loads	10A	—	10A	10A	6A	2A
			AC-15 Control of electromagnetic loads (> 72VA)	10A	—	7A	5A	3A	1A
	Operational Current	DC	DC-12 Control of resistive loads & solid state loads	8A	5A	—	2.2A	1.1A	—
DC-13 Control of electromagnets			5A	2A	—	1.1A	0.6A	—	

Non-Illuminated Pushbuttons (Assembled)

A3

Switches & Pilot Devices



Assembled Pushbuttons

A B () W 1 10 () - B

Function

- B: Momentary
- O: Maintained
- K: Key On/Off Lock

Bezel Shape

- Blank: Octagonal
- F: Full Shroud
- G: Mushroom Shroud
- Q: Square

Button Color

- B: Black G: Green W: White
- R: Red S: Blue Y: Yellow

Terminal Style

- Blank: Standard
- N: Fingersafe (IP20)

Contact Arrangement

- 10: 1NO 01: 1NC
- 20: 2NO 02: 2NC
- 11: 1NO-1NC 22: 2NO-2NC

Button Shape

- 1: Flush
- 2: Extended
- 3: Mushroom Head Ø 29mm
- 4: Mushroom Head Ø 40mm

Series Designation

- W: TW Series



To be used for interpreting part numbers only, not for part number development.

Non-Illuminated Pushbuttons (Assembled) con't

Part Numbers: Non-illuminated Pushbuttons

Style	Contacts	Momentary Action	Maintained Action
Flush	1NO 1NC 1NO-1NC 2NO 2NC	ABW110-① ABW101-① ABW111-① ABW120-① ABW102-①	AOW110-① AOW101-① AOW111-① AOW120-① AOW102-①
Extended	1NO 1NC 1NO-1NC 2NO 2NC	ABW210-① ABW201-① ABW211-① ABW220-① ABW202-①	AOW210-① AOW201-① AOW211-① AOW220-① AOW202-①
Recessed	1NO 1NC 1NO-1NC 2NO 2NC	ABFW110-① ABFW101-① ABFW111-① ABFW120-① ABFW102-①	AOFW110-① AOFW101-① AOFW111-① AOFW120-① AOFW102-①
Extended with Full Shroud	1NO 1NC 1NO-1NC 2NO 2NC	ABFW210-① ABFW201-① ABFW211-① ABFW220-① ABFW202-①	AOFW210-① AOFW201-① AOFW211-① AOFW220-① AOFW202-①
Ø 29mm Mushroom Head	1NO 1NC 1NO-1NC 2NO 2NC	ABW310-① ABW301-① ABW311-① ABW320-① ABW302-①	AOW310-① AOW301-① AOW311-① AOW320-① AOW302-①
Ø 40mm Mushroom Head	1NO 1NC 1NO-1NC 2NO 2NC	ABW410-① ABW401-① ABW411-① ABW420-① ABW402-①	AOW410-① AOW401-① AOW411-① AOW420-① AOW402-①
Ø 40mm Mushroom Head with Full Shroud	1NO 1NC 1NO-1NC 2NO 2NC	ABGW410-① ABGW401-① ABGW411-① ABGW420-① ABGW402-①	AOGW410-① AOGW401-① AOGW411-① AOGW420-① AOGW402-①
Square Flush	1NO 1NC 1NO-1NC 2NO 2NC	ABQW110-① ABQW101-① ABQW111-① ABQW120-① ABQW102-①	AQQW110-① AQQW101-① AQQW111-① AQQW120-① AQQW102-①
Square Extended	1NO 1NC 1NO-1NC 2NO 2NC	ABQW210-① ABQW201-① ABQW211-① ABQW220-① ABQW202-①	AQQW210-① AQQW201-① AQQW211-① AQQW220-① AQQW202-①
Keylock Push On/Off	1NO 1NC 1NO-1NC 2NO 2NC	AKW210 AKW201 AKW211 AKW220 AKW202	—

① Button Color Code

Color	Code
Black	B
Green	G
Red	R
Blue	S
White	W
Yellow	Y

A3

Switches & Pilot Devices



1. In place of ①, specify the Button Color Code from table.
2. For sub-assembled part numbers, see page A3-130.
3. For accessories, see page A3-156.
4. For dimensions, see page A3-158.
5. Keyed switches are supplied with two keys. All units are keyed alike. For custom keys, contact IDEC.

Non-Illuminated Pushbuttons (Sub-Assembled)

Contact Blocks + Operator + Button = Complete Part



A3

Switches & Pilot Devices

Part Numbers: Operators

Style	Part Number	
	Momentary	Maintained
Round Flush/Extended 	ABW-100	AOW-100
Round with Full Shroud 	ABFW-200	AOFW-200
Ø 40mm, Ø 29mm Mushroom Head 	ABW-300	AOW-300
Ø 40mm Mushroom Head with Full Shroud 	ABGW-400	AOGW-400
Square Flush/Extended 	ABQW-100	AQW-100
Keylock Push On/Off 	AKW-200	

Part Numbers: Buttons

Style	Part Number
Round Flush 	ABW1B-①
Round Extended 	ABW2B-①
Ø 29mm Mushroom 	ABW3B-①
Ø 40mm Mushroom 	ABW4B-①
Square Flush 	ABQW1B-①
Square Extended 	ABQW2B-①



In place of ①, specify the Button Color Code from table.

Part Numbers: Contact Blocks

Description	Part Number	
	1NO	1NC
Standard Exposed Screw 	HW-C10 HW-C10R (early make)	HW-C01 HW-C01R (late break)
Fingersafe (IP20), CE marked 	HW-F10 HW-F10R (early make)	HW-F01 HW-F01R (late break)
Dummy Block 	TW-DB	



- Dummy blocks (no contacts) are used with an odd number of contact blocks.
- Use of early and late break contacts creates a make before break function

① Button Color Code

Color	Code
Black	B
Green	G
Red	R
Blue	S
White	W
Yellow	Y

E-Stops (Assembled)



A3

Switches & Pilot Devices

Assembled E-Stops

A V (L) W 4 (B) (99) 11 (D) (N) - R - (24V)

<p>Function</p> <p>V: Pushlock Turn Reset Y: Push-Pull X: Pushlock Key Reset</p> <p>Illumination</p> <p>Blank: None L: Illuminated</p> <p>Series Designation</p> <p>W: TW Series</p> <p>Button/Lens Size</p> <p>3: 29mm Mushroom 4: 40mm Mushroom</p> <p>Lens Type (illuminated units only)</p> <p>Blank: Standard (ribbed) B: Engravable (smooth with insert)</p> <p>Illuminated Circuit (illuminated unit only)</p> <p>99: Full Voltage (lamp determines voltage) 126: 120V AC Step Down Transformer 246: 240V AC Step Down Transformer 486: 480V AC Step Down Transformer</p>	<p>Lamp Voltage (full voltage illuminated units only)</p> <p>6V: 6V AC/DC 12V: 12V AC/DC 24V: 24V AC/DC 120V: 120V AC (LED only) 240V: 240V AC (LED only)</p> <p>Button/Lens Color</p> <p>A: Amber R: Red W: White G: Green S: Blue Y: Yellow B: Black</p> <p>Contact Terminal Style</p> <p>Blank: Standard N: Fingersafe (IP20)</p> <p>Lamp Type (illuminated units only)</p> <p>Blank: Incandescent D: LED</p> <p>Contact Arrangement</p> <p>10: 1NO 01: 1NC 20: 2NO 02: 2NC 11: 1NO/1NC 22: 2NO/2NC</p>
--	--



Use only for interpreting part numbers. Do not use for developing part numbers.

E-Stops (Assembled) con't

Part Numbers: Non-Illuminated E-Stops

Style	Contacts	Part Number
Ø 40mm Pushlock Turn Reset* 	1NO 1NC 1NO-1NC 2NO 2NC	AVW410-R* AVW401-R* AVW411-R* AVW420-R* AVW402-R*
Ø 29mm Pushlock Turn Reset* 	1NO 1NC 1NO-1NC 2NO 2NC	AVW310-R* AVW301-R* AVW311-R* AVW320-R* AVW302-R*
Ø 40mm Push-Pull 	1NO 1NC 1NO-1NC 2NO 2NC	AYW410-① AYW401-① AYW411-① AYW420-① AYW402-①
Ø 40mm Pushlock Key Reset * 	1NO 1NC 1NO-1NC 2NO 2NC	AXW410- R* AXW401- R* AXW411- R* AXW420- R* AXW402- R*

- 1. *Available in Red only.
- 2. In place of ①, specify the Button Color Code from table.
- 3. For sub-assembled part numbers, see page A3-130.
- 4. For accessories, see page A3-156.
- 5. For dimensions, see page A3-158.

Part Numbers: Illuminated E-Stops

Style	Type	Contacts	Part Number
Ø 40mm Pushlock Turn Reset Type 	Transformer	1NO-1NC 2NO 2NC	AVLW4 ④ 11⑤-R* AVLW4 ④ 20⑤-R* AVLW4 ④ 02⑤-R*
	Full Voltage	1NO-1NC 2NO 2NC	AVLW49911⑤-R*-③ AVLW49920⑤-R*-③ AVLW49902⑤-R*-③
Ø 29mm Pushlock Turn Reset 	Transformer	1NO-1NC 2NO 2NC	AVLW3④11⑤-R* AVLW3④20⑤-R* AVLW3④02⑤-R*
	Full Voltage	1NO-1NC 2NO 2NC	AVLW39911⑤-R*-③ AVLW39920⑤-R*-③ AVLW39902⑤-R*-③
Ø 40mm Push-Pull 	Transformer	1NO-1NC 2NO 2NC	AYLW4 ④ 11⑤-② AYLW4 ④ 20⑤-② AYLW4 ④ 02⑤-②
	Full Voltage	1NO-1NC 2NO 2NC	AYLW49911⑤-②-③ AYLW49920⑤-②-③ AYLW49902⑤-②-③

- 1. *Available in red only.
- 2. In place of ②, specify the Lens Color Code (see table above).
- 3. In place of ③, specify the Full Voltage Code (lamp voltage) (see table above).
- 4. In place of ④, specify the Transformer Voltage Code (see table above).
- 5. In place of ⑤, specify the Lamp Type Code from table above.
- 6. For sub-assembly part numbers, see page A3-134.
- 7. For accessories, see page A3-156.
- 8. For dimensions, see page A3-158.

① Button Color Code

Color	Code
Black	B
Green	G
Red	R
Blue	S
White	W
Yellow	Y

② LED/Lens Color Code

Color	Code
Amber	A
Green	G
Red	R
Blue	S
White	W

③ Full Voltage Code

Voltage	Code
6V AC/DC	6V
12V AC/DC	12V
24V AC/DC	24V
120V AC	120V (LED only)
240V AC	240V (LED only)

④ Transformer Voltage Codes

Voltage	Code
120VAC	126
240VAC	246
480VAC	486

⑤ Lamp Type Code

Lamp	Code
Incandescent	Blank
LED	D

Transformers step down to 6V.

E-Stops (Sub-Assembled)

Transformer/ Adaptor* + Contacts + Lamp Holder + Operator + Lamp + Button or Lens = Complete Part





* Not applicable for full voltage units

Part Numbers: Operators

Style	Part Number	
	Non-illuminated	Illuminated
Ø 29/Ø 40mm Pushlock Turn Reset 	AVW-300	AVLW3-0600
Ø 40mm Push-Pull 	AYW-400	AYLW4-0600
Ø 40mm Pushlock Key Reset 	AXW-300	—





Part Numbers: Lamps

Type	Voltage	Part Number
LED 	6V AC/DC	LSTD-6 ^②
	12V AC/DC	LSTD-1 ^②
	24V AC/DC	LSTD-2 ^②
	120V AC	LSTD-H2 ^②
	240V AC	LSTD-M4 ^②
Incandescent 	6V AC/DC	IS-6
	12V AC/DC	IS-12
	24V AC/DC	IS-24



- In place of ^②, specify the LED color code.
- The LED contains a current-limiting resistor and a protection diode.

Part Numbers: Buttons

Style	Part Number
Ø 40mm Pushlock Turn Reset 	AVW4B-R*
Ø 29mm Pushlock Turn Reset 	AVW3B-R*
Ø 40mm Push-Pull 	AYW4B-①
Ø 40mm Pushlock Key Reset 	AXW4B-R*



- *Available in Red only
- In place of ①, specify the button color code from table below.

① Button Color Code

Color	Code
Black	B
Green	G
Red	R
Blue	S
White	W
Yellow	Y

② LED/Lens Color Code

Color	Code
Amber	A
Green	G
Red	R
Blue	S
White	W

A3

Switches & Pilot Devices

Illuminated E-Stops (Sub-Assembled) con't





Part Numbers: Lenses

Style	Part Number	
	Standard	Engravable
 Ø 29mm Head Pushlock Turn Reset	AVLW3LU-R*	AVLW3BLU-R*
 Ø 40mm Head Pushlock Turn Reset	AVLW4LU-R*	AVLW4BLU-R*
 Ø 40mm Head Push Pull	AYLW4LU-②	AYLW4BLU-②



- In place of ②, specify the lens color code from table on the bottom right.
- *Available only in red
- Standard lenses have ribbed pattern, Engravable lenses are smooth and include an engravable insert.



Part Numbers: Transformers/Full Voltage Modules

Style	Description		Part Number
 Full Size Transformer	Standard	120V AC	TW-T126B
		240V AC	TW-T246B
		480V AC	TW-T486B
	Fingersafe	120V AC	TW-F126B
		240V AC	TW-F246B
	480V AC	TW-F486B	
 Half Size Transformer	120V AC		TW-T126SB
	240V AC		TW-T246SB
 Full voltage model (use with even number of contacts)	Standard		TW-DA1B
	Fingersafe		TW-DA1FB
 Full voltage model (use with odd number of contacts)	Standard		HW-DA1B
	Fingersafe		HW-DA1FB





All Transformers step down to 6V (use 6V lamp).

Part Numbers: Lamp Circuit Components

Style	Application	Part Number
 Short Lamp Holder	Used with a Half-size Transformer and one contact block	TW-LH1
 Long Lamp Holder	Used with Full-size Transformer and two contact blocks Used with Half-size Transformer and three contact blocks Used with Full Voltage Adaptor and two contact blocks	TW-LH2
 Lead Holder	Used with TW-LH2 holder when using four contact blocks	HW-LH3

Part Numbers: Contact Blocks

Description	Part Number	
	1NO	1NC
 Standard Exposed Screw	HW-C10	HW-C01
	HW-C10R (early make)	HW-C01R (late break)
 Fingersafe (IP20), CE marked	HW-F10	HW-F01
	HW-F10R (early make)	HW-F01R (late break)
 Dummy Block	TW-DB	



- Dummy blocks (no contacts) are used with an odd number of contact blocks.
- Use of early and late break contacts creates a make before break function

Pilot Lights (Assembled)



A3

Switches & Pilot Devices

Assembled Pilot Lights

A P (Q) W 1 (B) 99 (D) - R - (24V)

<p>Function _____</p> <p>P: Pilot Light</p> <p>Bezel Shape _____</p> <p>Blank: Octagonal (round lenses) Q: Square</p> <p>Series Designation _____</p> <p>W: TW Series</p> <p>Lens Shape _____</p> <p>1: Flat 2: Dome</p> <p>Lens Type _____</p> <p>Blank: Standard (ribbed) B: Engravable (smooth with insert included)</p> <p>Illumination Circuit _____</p> <p>99: Full Voltage (lamp determines voltage) 126:120V AC Step Down Transformer 246:240V AC Step Down Transformer 486:480V AC Step Down Transformer</p>	<p>Lamp Voltage (Full Voltage Units Only) 6V: 6V AC/DC 12V: 12V AC/DC 24V: 24V AC/DC 120V: 120V AC (LED only) 240V: 240V AC (LED only)</p> <p>Lens Color Code A: Amber G: Green R: Red S: Blue W: White Y: Yellow</p> <p>Lamp Type Blank: Incandescent D: LED</p>
---	--





1. Use only when interpreting part numbers. Do not use for developing part numbers.
2. All transformers step down to 6V.

Pilot Lights (Assembled) con't

Part Numbers: Pilot Lights

A3

Switches & Pilot Devices

Style		Operating Voltage	Part Number
 Round Flat	Transformer	120VAC 240VAC 480VAC	APW1126 ^{④-②} APW1246 ^{④-②} APW1486 ^{④-②}
	Full Voltage	—	APW199 ^{④-②-③}
 Dome	Transformer	120VAC 240VAC 480VAC	APW2126 ^{④-②} APW2246 ^{④-②} APW2486 ^{④-②}
	Full Voltage	—	APW299 ^{④-②-③}
 Square Flat	Transformer	120VAC 240VAC 480VAC	APQW1B126 ^{④-②} APQW1B246 ^{④-②} APQW1B486 ^{④-②}
	Full Voltage	—	APQW1B99 ^{④-②-③}

-  1. In place of ②, specify the Lens Color Code from table below.
 2. In place of ③, specify the Full Voltage Code from table below.
 3. In place of ④, specify the Lamp Type Code from table below.
 4. For accessories, see page A3-156.
 5. For dimensions, see page A3-158.
 6. For sub-assembly part numbers, see next page.

② Lens Color Code

Color	Code
Amber	A
Green	G
Red	R
Blue	S
White	W
Yellow	Y

③ Full Voltage Code

Voltage	Code
6V AC/DC	6V
12V AC/DC	12V
24V AC/DC	24V
120V AC	120V (LED only)
240V AC	240V (LED only)

④ Lamp Type Code

Lamp	Code
Incandescent	Blank
LED	D

Pilot Lights (Sub-Assembled)

A3

Switches & Pilot Devices



Transformer + Operator + Lamp + Lens = Complete Part



*Transformer not required for full voltage units.





Part Numbers: Operators

Style	Part Number
Round Dome/Flat 	APW-199
Square 	UPQW-199

Same operator is used for full voltage as for transformer completed units.



Part Numbers: Lamps

Type	Voltage	Part Number
LED 	6V AC/DC	LSTD-6②
	12V AC/DC	LSTD-1②
	24V AC/DC	LSTD-2②
	120V AC	LSTD-H2②
	240V AC	LSTD-M4②
Incandescent 	6V AC/DC	IS-6
	12V AC/DC	IS-12
	24V AC/DC	IS-24
	30V AC/DC	IS-30



- In place of ②, specify the LED Color Code from table below.
- The LED contains a current-limiting resistor and diode bridge.

Part Numbers: Lenses

Style	Part Number	
	Standard	Engravable
Dome	APW2LU-②	—
Round Flat	APW1LU-②	APW1BLU-②
Square Flat	—	APQW1BLU-②

- In place of ②, specify the Lens Color Code from table below.
- Standard lenses have a ribbed lens to enhance light dispersion. Marking lenses are smooth and include an engravable insert.



Part Numbers: Transformers

Style	Description	Part Number	
	Standard	120V AC	TW-T126B
		240V AC	TW-T246B
		480V AC	TW-T486B
	Fingersafe	120V AC	TW-F126B
		240V AC	TW-F246B
		480V AC	TW-F486B



All Transformers step down to 6V (use 6V lamp).

② Lens/LED Color Code

Color	Code
Amber	A
Green	G
Red	R
Blue	S
White	W
Yellow	Y

If clear lens is desired, use white marking lens and remove engraving insert



Illuminated Pushbuttons (Assembled)

A3

Switches & Pilot Devices



Assembled Illuminated Pushbuttons

A L (F) W 2 (B) 99 11 (D) (N) - R - (24V)

Function

- L: Momentary Action
- OL: Maintained Action

Bezel Shape

- Blank: Octagonal (round lenses)
- F: Full Shroud (round lenses)
- Q: Square

Series Designation

- W: TW series

Lens Shape/Size

- 2: Standard Extended (round or square)
- 3: 29mm Mushroom
- 4: 40mm Mushroom

Lens Type

- Blank: Standard (ribbed)
- B: Engravable (smooth with insert)

Illumination Circuit

- 99: Full Voltage (lamp determines voltage)
- 126: 120V AC Step Down Transformer
- 246: 240V AC Step Down Transformer
- 486: 480V AC Step Down Transformer

Lamp Voltage

- (Full Voltage Units Only)
- 6V: 6V AC/DC
 - 12V: 12V AC/DC
 - 24V: 24V AC/DC
 - 120V: 120V AC (LED only)
 - 240V: 240V AC (LED only)

Lens Code

- A: Amber
- G: Green
- R: Red
- S: Blue
- W: White
- Y: Yellow

Contact Terminal Style

- Blank: Standard
- N: Fingersafe

Lamp Type

- Blank: Incandescent Lamp
- D: LED Lamp

Contact Arrangement





- 10: 1NO
- 20: 2NO
- 11: 1NO-1NC
- 01: 1NC
- 02: 2NC
- 22: 2NO-2NC



1. Use only when interpreting part numbers. Do not use for developing part numbers.
2. Transformers step down to 6V.

Illuminated Pushbuttons (Assembled)

Part Numbers: Illuminated Pushbuttons

Style		Contacts	Part Number	
			Momentary	Maintained
 Extended Lens	Transformer Type	1NO-1NC 2NO 2NC	ALW2 ④ 11⑤-② ALW2 ④ 20⑤-② ALW2 ④ 02⑤-②	AOLW2 ④ 11⑤-② AOLW2 ④ 20⑤-② AOLW2 ④ 02⑤-②
	Full Voltage	1NO-1NC 2NO 2NC	ALW29911⑤-②-③ ALW29920⑤-②-③ ALW29902⑤-②-③	AOLW29911⑤-②-③ AOLW29920⑤-②-③ AOLW29902⑤-②-③
 Extended Lens with Full Shroud	Transformer Type	1NO-1NC 2NO 2NC	ALFW2 ④ 11⑤-② ALFW2 ④ 20⑤-② ALFW2 ④ 02⑤-②	AOLFW2 ④ 11⑤-② AOLFW2 ④ 20⑤-② AOLFW2 ④ 02⑤-②
	Full Voltage	1NO-1NC 2NO 2NC	ALFW29911⑤-②-③ ALFW29920⑤-②-③ ALFW29902⑤-②-③	AOLFW29911⑤-②-③ AOLFW29920⑤-②-③ AOLFW29902⑤-②-③
 Ø 29mm Mushroom Lens	Transformer Type	1NO-1NC 2NO 2NC	ALW3 ④ 11⑤-② ALW3 ④ 20⑤-② ALW3 ④ 02⑤-②	AOLW3 ④ 11⑤-② AOLW3 ④ 20⑤-② AOLW3 ④ 02⑤-②
	Full Voltage	1NO-1NC 2NO 2NC	ALW39911⑤-②-③ ALW39920⑤-②-③ ALW39902⑤-②-③	AOLW39911⑤-②-③ AOLW39920⑤-②-③ AOLW39902⑤-②-③
 Ø 40mm Mushroom Lens	Transformer Type	1NO-1NC 2NO 2NC	ALW4 ④ 11⑤-② ALW4 ④ 20⑤-② ALW4 ④ 02⑤-②	AOLW4 ④ 11⑤-② AOLW4 ④ 20⑤-② AOLW4 ④ 02⑤-②
	Full Voltage	1NO-1NC 2NO 2NC	ALW49911⑤-②-③ ALW49920⑤-②-③ ALW49902⑤-②-③	AOLW49911⑤-②-③ AOLW49920⑤-②-③ AOLW49902⑤-②-③
 Square Extended	Transformer Type	1NO-1NC 2NO 2NC	ALQW2B ④ 11⑤-② ALQW2B ④ 20⑤-② ALQW2B ④ 02⑤-②	AOLQW2B ④ 11⑤-② AOLQW2B ④ 20⑤-② AOLQW2B ④ 02⑤-②
	Full Voltage	1NO-1NC 2NO 2NC	ALQW2B9911⑤-②-③ ALQW2B9920⑤-②-③ ALQW2B9902⑤-②-③	AOLQW2B9911⑤-②-③ AOLQW2B9920⑤-②-③ AOLQW2B9902⑤-②-③



- In place of ②, specify the Lens Color Code (see table above). Mushroom lenses not available in yellow.
- In place of ③, specify the Full Voltage Code (lamp voltage) (see table above).
- In place of ④, specify the Transformer Voltage Code (see table above).
- In place of ⑤, specify the Lamp Type Code from table above.
- For sub-assembly part numbers, see page A3-140.
- For accessories, see page A3-156.
- For dimensions, see page A3-158.

② Lens/LED Color Code

Color	Code
Amber	A
Green	G
Red	R
Blue	S
White	W
Yellow	Y

③ Full Voltage Code

Voltage	Code
6V AC/DC	6V
12V AC/DC	12V
24V AC/DC	24V
120V AC	120V (LED only)
240V AC	240V (LED only)

④ Transformer Voltage Codes

Voltage	Code
120VAC	126
240VAC	246
480VAC	486

⑤ Lamp Type Code

Lamp	Code
Incandescent	Blank
LED	D



Mushroom lenses not available in yellow.



Transformers step down to 6V (use 6V lamp).

Illuminated Pushbuttons (Sub-Assembled)

Transformer/ Adaptor* + Contacts + Lamp Holder + Operator + Lamp + Lens = Complete Part



A3

Switches & Pilot Devices

* Not applicable for full voltage units

Part Numbers: Operators

Style	Part Number	
	Momentary	Maintained
Extended	ALW-0600	AOLW-0600
Extended with Full Shroud	ALFW-0600	AOLFW-0600
ø29mm/ø40mm Mushroom	ALW3-0600	AOLW3-0600
Square/Extended	ALQW-2B0600	AOLQW-2B0600



Part Numbers: Lenses

Style	Part Number	
	Standard	Engravable
Round Extended 	ALW2LU-②	ALW2BLU-②
Ø 29mm Mushroom Head* 	ALW3LU-②	ALW3BLU-②
Ø 40mm Mushroom Head* 	ALW4LU-②	ALW4BLU-②
Square Extended 	—	ALQW2BLU-②



- In place of ②, specify the lens color code from table on the bottom right.
- * Mushroom lens not available in yellow.
- Standard lenses have ribbed pattern, Engravable lenses are smooth and include an engravable insert.



Part Numbers: Lamps

Type	Voltage	Part Number
LED 	6V AC/DC	LSTD-6②
	12V AC/DC	LSTD-1②
	24V AC/DC	LSTD-2②
	120V AC	LSTD-H2②
	240V AC	LSTD-M4②
Incandescent 	6V AC/DC	IS-6
	12V AC/DC	IS-12
	24V AC/DC	IS-24



- In place of ②, specify the LED Color Code.
- The LED contains a current-limiting resistor and a protection diode.

Part Numbers: Lamp Circuit Components



Style	Application	Part Number
Short Lamp Holder 	Used with a Half-size Transformer and one contact block	TW-LH1
Long Lamp Holder 	Used with Full-size Transformer and two contact blocks Used with Half-size Transformer and three contact blocks Used with Full Voltage Adaptor and two contact blocks	TW-LH2
Lead Holder 	Used with TW-LH2 holder when using four contact blocks	HW-LH3

② LED/Lens Color Code

Color	Code
Amber	A
Green	G
Red	R
Blue	S
White	W
Yellow	Y

Illuminated Pushbuttons (Sub-Assembled) con't





Part Numbers: Contact Blocks

Description	Part Number	
	1NO	1NC
Standard Exposed Screw 	HW-C10 HW-C10R (early make)	HW-C01 HW-C01R (late break)
Fingersafe (IP20) 	HW-F10 HW-F10R (early make)	HW-F01 HW-F01R (late break)
Dummy Block 	TW-DB	



- Dummy blocks (no contacts) are used with an odd number of contact blocks.
- Use of early and late break contacts creates a make before break function.

Part Numbers: Transformers/Full Voltage Modules

Style	Description	Part Number
Full Size Transformer 	Standard	120V AC TW-T126B
		240V AC TW-T246B
		480V AC TW-T486B
	Fingersafe	120V AC TW-F126B
		240V AC TW-F246B
		480V AC TW-F486B
Half Size Transformer 	120V AC	TW-T126SB
	240V AC	TW-T246SB
Full voltage model (use with even number of contacts) 	Standard	TW-DA1B
	Fingersafe	TW-DA1FB
Full voltage model (use with odd number of contacts) 	Standard	HW-DA1B
	Fingersafe	HW-DA1FB



All Transformers step down to 6V (use 6V lamp).

Non-Illuminated Selector Switches (Assembled)

A3

Switches & Pilot Devices



Assembled Selector Switches

A S W 3 (1) (L) 20 (N) - 304

Function

S: Selector Switch

Series Designation

W: TW Series

Number of Positions

2: 2-Position

3: 3-Position

4: 4-Position

5: 5-Position

Spring Return Action

Blank: Maintained

1: Spring return from Right (2 or 3 position)

2: Spring return from Left (2 or 3 position)

3: 2-Way spring return from Left and Right (3 position only)

Circuit Number

(Standard circuits shown on following pages and A3-150.)

Contacts Terminal Style

Blank: standard

N: Fingersafe (IP20)

Contact Arrangement Code

10: 1NO 01: 1NC

20: 2NO 02: 2NC

40: 4NO 04: 4NC

11: 1NO-1NC 22: 2NO-2NC

Operator Style Code

Blank: Knob Operator

L: Lever Operator

K: Key Operator



1. Use only when interpreting part numbers. Do not use for developing part numbers.
2. Custom contact configurations available, contact IDEC for details.
3. Portions of part number inside () are optional.

Non-Illuminated Selector Switches (Assembled) con't

Part Numbers: 2-Position Selector Switches

Contact	Mounting	Operator Position		Key	Part Number	Part Number	Part Number
		L	R		Maintained	Spring Return from Right	Spring Return from Left
1NO	1 2	0	X	Knob Lever Key	ASW210 ASW2L10 ASW2K10	ASW2110 ASW21L10 ASW21K10	ASW2210 ASW22L10 ASW22K10
		0	0				
1NC	1 2	X	0	Knob Lever Key	ASW201-116 ASW2L01-116 ASW2K01-116	ASW2101-116 ASW21L01-116 ASW21K01-116	ASW2201-116 ASW22L01-116 ASW22K01-116
		0	0				
1NO 1NC	1 2	X	0	Knob Lever Key	ASW211 ASW2L11 ASW2K11	ASW2111 ASW21L11 ASW21K11	ASW2211 ASW22L11 ASW22K11
		0	X				
2NO	1 2	0	X	Knob Lever Key	ASW220 ASW2L20 ASW2K20	ASW2120 ASW21L20 ASW21K20	ASW2220 ASW22L20 ASW22K20
		0	X				
2NC	1 2	X	0	Knob Lever Key	ASW202-104 ASW2L02-104 ASW2K02-104	ASW2102-104 ASW21L02-104 ASW21K02-104	ASW2202-104 ASW22L02-104 ASW22K02-104
		X	0				
2NO 2NC	1 2 3 4	0	X	Knob Lever Key	ASW222 ASW2L22 ASW2K22	ASW2122 ASW21L22 ASW21K22	ASW2222 ASW22L22 ASW22K22
		X	0				
2NO 2NC	1 2 3 4	0	X	Knob Lever Key	ASW222-111 ASW2L22-111 ASW2K22-111	ASW2122-111 ASW21L22-111 ASW21K22-111	ASW2222-111 ASW22L22-111 ASW22K22-111
		X	0				



A3

Switches & Pilot Devices

Part Numbers: 3-Position Selector Switches

Contact	Mounting	Operator Position			Key	Part Number	Part Number	Part Number	Part Number
		L	C	R		Maintained	Spring Return from Right	Spring Return from Left	Spring Return Two-Way
2NO	1 2	X	0	0	Knob Lever Key	ASW320 ASW3L20 ASW3K20	ASW3120 ASW31L20 ASW31K20	ASW3220 ASW32L20 ASW32K20	ASW3320 ASW33L20 ASW33K20
		0	0	X					
2NC	1 2	0	X	X	Knob Lever Key	ASW302 ASW3L02 ASW3K02	ASW3102 ASW31L02 ASW31K02	ASW3202 ASW32L02 ASW32K02	ASW3302 ASW33L02 ASW33K02
		X	X	0					
2NO 2NC	1 2 3 4	X	0	0	Knob Lever Key	ASW322 ASW3L22 ASW3K22	ASW3122 ASW31L22 ASW31K22	ASW3222 ASW32L22 ASW32K22	ASW3322 ASW33L22 ASW33K22
		0	X	X					
2NO 2NC	1 2 3 4	X	0	X	Knob Lever Key	ASW322-309 ASW3L22-309 ASW3K22-309	ASW3122-309 ASW31L22-309 ASW31K22-309	ASW3222-309 ASW32L22-309 ASW32K22-309	ASW3322-309 ASW33L22-309 ASW33K22-309
		0	X	0					
2NO 2NC	1 2 3 4	0	X	0	Knob Lever Key	ASW322-310 ASW3L22-310 ASW3K22-310	ASW3122-310 ASW31L22-310 ASW31K22-310	ASW3222-310 ASW32L22-310 ASW32K22-310	ASW3322-310 ASW33L22-310 ASW33K22-310
		0	0	X					
4NO	1 2 3 4	X	0	0	Knob Lever Key	ASW340 ASW3L40 ASW3K40	ASW3140 ASW31L40 ASW31K40	ASW3240 ASW32L40 ASW32K40	ASW3340 ASW33L40 ASW33K40
		0	0	X					
4NC	1 2 3 4	0	X	X	Knob Lever Key	ASW304 ASW3L04 ASW3K04	ASW3104 ASW31L04 ASW31K04	ASW3204 ASW32L04 ASW32K04	ASW3304 ASW33L04 ASW33K04
		X	X	0					



- The truth table indicates the operating position of contact block when the operator is switched to that position.
X = On (closed contacts)
O = Off (open contacts)
X-X = Overlapping Contacts: Remain on (closed contacts) when switch is moved between these two positions.
- All knob and lever selector switches come in black. Other colors are available by ordering the knob or lever separately.
- Every key selector switch uses an identical key. The key is removable in any maintained position. If a different configuration is required, contact an IDEC representative for more information.
- Custom contact configurations are available, see page A3-150 or contact IDEC for details.

Non-Illuminated Selector Switches (Assembled) con't

Part Numbers: 4-Position Selector Switch

		Operator Position					Maintained Part Number
Contact	Mounting	1	2	3	4		
2NO	1	X	0	0	0	Knob Lever	ASW422-411 ASW4L22-411
2NC	2	0	X	0	0		
	3	0	0	X	0		
	4	0	0	0	X		

Part Numbers: 5-Position Selector Switch

		Operator Position						Maintained Part Number
Contact	Mounting	1	2	3	4	5		
2NO	1	X	0	0	0	0	Knob Lever	ASW522-501 ASW5L22-501
2NC	2	0	X	0	0	0		
	3	0	0	0	X	0		
	4	0	0	0	0	X		

A3
Switches & Pilot Devices



Non-Illuminated Selector Switches (Sub-Assembled)

Contact Blocks + **Operator** + **Knob or Lever *** + **Color Insert *** = **Complete Part †**



- * Not needed with key type switches.
- † Knob type shown.

Part Numbers: Operators

Style	Positions	Description	Part Number	
Knob/Lever 	2	Maintained	ASW200	
		Spring return from right	ASW2100	
		Spring return from left	ASW2200	
	3	Maintained, Cam 1 Maintained, Cam 2 Maintained, Cam 3		ASW300-1 ASW300-2 ASW300-3
			Spring return from right, Cam 1 Spring return from right, Cam 2	ASW3100-1 ASW3100-2
			Spring return from left, Cam 1 Spring return from left, Cam 2	ASW3200-1 ASW3200-2
		Spring return from left/right, Cam 1 Spring return from left/right, Cam 2	ASW3300-1 ASW3300-2	
		4	Maintained, Standard Cam Maintained, Cam 1	ASW400 ASW400-1
		5	Maintained, Standard cam Maintained, Cam 1	ASW500 ASW500-1
	Key 	2	Maintained	ASW2K00
Spring return from right			ASW21K00	
Spring return from left			ASW22K00	
3		Maintained, Cam 1 Maintained, Cam 2 Maintained, Cam 3		ASW3K00-1 ASW3K00-2 ASW3K00-3
			Spring return from right, Cam 1 Spring return from right, Cam 2	ASW31K00-1 ASW31K00-2
			Spring return from left, Cam 1 Spring return from left, Cam 2	ASW32K00-1 ASW32K00-2
		Spring return from left/right, Cam 1 Spring return from left/right, Cam 2	ASW33K00-1 ASW33K00-2	



- Two keys are supplied with every switch, all are keyed alike, and removable from any maintained position. For other configurations, consult your IDEC representative.
- Locking rings are included with all operators. Order knobs, levers, and color inserts separately.
- Different cams produce different contact actions. For details, see contact arrangement charts, page A3-150.

① Handle/Insert Color Code



Color	Code
Black*	B
Blue	S
Green	G
Red	R
Yellow	Y
White†	W

* Color inserts not available in black.
† Knob and lever not available in white.

Part Numbers: Handles and Inserts

Style	Part Number
Knob 	ASWHHY-①
Lever 	ASWHHL-①
Color Insert 	TW-HC1-①

Part Numbers: Contact Blocks

Style	Part Number	
	1NO	1NC
Standard 	HW-C10 HW-C10R (early make)	HW-C01 HW-C01R (late break)
Fingersafe (IP20) 	HW-F10 HW-F10R (early make)	HW-F01 HW-F01R (late break)
Dummy Block 	TW-DB	



- Push rod color code: Green = NO contact block
Red = NC contact block.
- Dummy blocks (no contacts) are used with an odd number of contact blocks.

Illuminated Selector Switches (Assembled)

A3

Switches & Pilot Devices



Assembled Illuminated Selector Switches

A SL W 2 (2) 99 11 (D) (N) - (202) - R - (24V)

Function

SL: Illuminated Selector Switch

Series Designation

W: TW Series

Number of Positions

- 2: 2-Position
- 3: 3-Position

Spring Return Action

- Blank: Maintained
- 1: Spring return from Right
- 2: Spring return from Left
- 3: Two-Way spring return from Left & Right

Illumination Circuit

- 99: Full Voltage (lamp determines voltage)
- 126: 120V AC Step Down Transformer
- 246: 240V AC Step Down Transformer
- 486: 480V AC Step Down Transformer

Lamp Voltage

(Full Voltage Units Only)

- 6V: 6V AC/DC
- 12V: 12V AC/DC
- 24V: 24V AC/DC
- 120V: 120V AC (LED only)
- 240V: 240V AC (LED only)

Lens Color Code

- A: Amber
- G: Green
- R: Red
- S: Blue
- W: White
- Y: Yellow

Contact Circuit No.

Standard circuits are listed on the following pages and A3-150.

Contacts Terminal Style

- Blank: standard
- N: Fingersafe (IP20)

Lamp Type

- Blank: Incandescent
- D: LED

Contact Arrangement Code

- 10: 1NO 01: 1NC
- 20: 2NO 02: 2NC
- 40: 4NO 04: 4NC
- 11: 1NO-1NC 22: 2NO-2NC



1. Use only when interpreting part numbers. Do not use for developing part numbers.
2. All transformers step down to 6V (use 6V lamp).

Illuminated Selector Switches (Assembled) con't

Part Numbers: Illuminated 2-Position Selector Switches

Style				Part Number			
Contact	Mounting	Operator Position		Lamp Circuit Type	Maintained	Spring Return from Right	Spring Return from Left
		L	R				
1NO 1NC	1	0	X	Transformer Full Voltage	ASLW2 ① 11④-② ASLW29911④-②-③	ASLW21 ① 11④-② ASLW219911④-②-③	ASLW22 ① 11④-② ASLW229911④-②-③
	2	X	0				
2NO	1	0	X	Transformer Full Voltage	ASLW2 ① 20④-② ASLW29920④-②-③	ASLW21 ① 20④-② ASLW219920④-②-③	ASLW22 ① 20④-② ASLW229920④-②-③
	2	0	X				
2NC	1	X	0	Transformer Full Voltage	ASLW2 ① 02④-104-② ASLW29902④-104-②-③	ASLW21 ① 02④-104-② ASLW219902④-104-②-③	ASLW22 ① 02④-104-② ASLW229902④-104-②-③
	2	X	0				
2NO 2NC	1	0	X	Transformer Full Voltage	ASLW2 ① 22④-② ASLW29922④-②-③	ASLW21 ① 22④-② ASLW219922④-②-③	ASLW22 ① 22④-② ASLW229922④-②-③
	2	X	0				
	3	0	X				
	4	X	0				

① Transformer Voltage Code

Voltage	Code
120V AC	126
240V AC	246
480V AC	486



Transformers step down to 6V (use 6V lamp).

② Lens Color Code

Color	Code	Color	Code
Amber	A	Blue	S
Green	G	White	W
Red	R	Yellow	Y

Part Numbers: Illuminated 3-Position Selector Switches Maintained and Spring Return from Right

Style				Part Number		Part Number		Part Number		Part Number	
Contact	Mounting	Operator Position			Lamp Circuit Type	Maintained	Spring Return From Right	Spring Return from Left	Spring Return Two-Way		
		L	C	R							
2NO	1	X	0	0	Transformer Full Voltage	ASLW3 ① 20④-② ASLW39920④-②-③	ASLW31 ① 20④-② ASLW319920④-②-③	ASLW32 ① 20④-② ASLW329920④-②-③	ASLW33 ① 20④-② ASLW339920④-②-③		
	2	0	0	X							
2NC	1	0	X	X	Transformer Full Voltage	ASLW3 ① 02④-② ASLW39902④-②-③	ASLW31 ① 02④-② ASLW319902④-②-③	ASLW32 ① 02④-② ASLW329902④-②-③	ASLW33 ① 02④-② ASLW339902④-②-③		
	2	X	X	0							
2NO 2NC	1	X	0	0	Transformer Full Voltage	ASLW3 ① 22④-② ASLW39922④-②-③	ASLW31 ① 22④-② ASLW319922④-②-③	ASLW32 ① 22④-② ASLW329922④-②-③	ASLW33 ① 22④-② ASLW339922④-②-③		
	2	0	0	X							
	3	0	X	X							
	4	X	X	0							
2NO 2NC	1	X	0	X	Transformer Full Voltage	ASLW3 ① 22④-309-② ASLW39922④-309-②-③	ASLW31 ① 22④-309-② ASLW319922④-309-②-③	ASLW32 ① 22④-309-② ASLW329922④-309-②-③	ASLW33 ① 22④-309-② ASLW339922④-309-②-③		
	2	X	X	0							
	3	0	X	0							
	4	0	0	X							
2NO 2NC	1	0	X	0	Transformer Full Voltage	ASLW3 ① 22④-310-② ASLW39922④-310-②-③	ASLW31 ① 22④-310-② ASLW319922④-310-②-③	ASLW32 ① 22④-310-② ASLW329922④-310-②-③	ASLW33 ① 22④-310-② ASLW339922④-310-②-③		
	2	0	0	X							
	3	0	X	0							
	4	0	0	X							
4NO	1	X	0	0	Transformer Full Voltage	ASLW3 ① 40④-② ASLW39940④-②-③	ASLW31 ① 40④-② ASLW319940④-②-③	ASLW32 ① 40④-② ASLW329940④-②-③	ASLW33 ① 40④-② ASLW339940④-②-③		
	2	0	0	X							
	3	X	0	0							
	4	0	0	X							
4NC	1	0	X	X	Transformer Full Voltage	ASLW3 ① 04④-② ASLW39904④-②-③	ASLW31 ① 04④-② ASLW319904④-②-③	ASLW32 ① 04④-② ASLW329904④-②-③	ASLW33 ① 04④-② ASLW339904④-②-③		
	2	X	X	0							
	3	0	X	X							
	4	X	X	0							



- In place of ①, specify the Transformer Voltage Code.
- In place of ②, specify the Lens/LED Color Code.
- In place of ③, specify the Full Voltage Code.
- In place of ④ specify Lamp Type Code
- For custom contact configuration, see page A3-150. Contact IDEC for details.

③ Full Voltage Code

Voltage	Code
6V AC/DC	6V
12V AC/DC	12V
24V AC/DC	24V
120V AC	120V (LED only)
240V AC	240V (LED only)

④ Lamp Type Code

Lamp	Code
Incandescent	Blank
LED	D

Illuminated Selector Switches (Sub-Assembled)

Transformer* + Contact Block + Operator + Lamp/Lead Holder † + Lamp + Lens = Complete Part



A3

Switches & Pilot Devices



1. * Full voltage units use a full voltage adaptor (TW-DA1B) instead of a transformer.
2. † Lamp holder is not included with operators, order separately.
Lead holder is used when using 3 or more contact blocks. Order separately.

Part Numbers: Operators

Positions	Description	Part Number
2	Maintained	ASLW200
	Spring return from right	ASLW2100
	Spring return from left	ASLW2200
3	Maintained, cam 1	ASLW300-1
	Maintained, cam 2	ASLW300-2
	Maintained, cam 3	ASLW300-3
	Spring return from right, cam 1	ASLW3100-1
	Spring return from right, cam 2	ASLW3100-2
	Spring return from left, cam 1	ASLW3200-1
Spring return from left, cam 2	ASLW3200-2	
3	Spring return from left/right, cam 1	ASLW3300-1
	Spring return from left/right, cam 2	ASLW3300-2



Different cams produce different contact action. For details, Contact Arrangements on page A3-150.

Part Numbers: Lamps (LED)

Type	Voltage	Part Number
LED	6V AC/DC	LSTD-6②
	12V AC/DC	LSTD-1②
	24V AC/DC	LSTD-2②
	120V AC	LSTD-H2②
	240V AC	LSTD-M4②
Incandescent	6V AC/DC	IS-6
	12V AC/DC	IS-12
	24V AC/DC	IS-24



1. In place of ②, specify the LED Color Code.
2. The LED contains a current-limiting resistor and a protection diodes.

Part Numbers: Lenses (Knobs)

Description	Part Number
Knob	ASLWLU-②





In place of ② specify Lens Color Code.

② LED/Lens Color Code

Color	Code
Amber	A
Green	G
Red	R
Blue	S
White	W
Yellow	Y

Illuminated Selector Switches (Sub-Assembled) con't



Part Numbers: Contact Blocks

Description	Part Number	
	1NO	1NC
Standard 	HW-C10 HW-C10R (early make)	HW-C01 HW-C01R (late break)
Fingersafe (IP20) 	HW-F10 HW-F10R (early make)	HW-F01 HW-F01R (late break)
Dummy Block 	TW-DB	







- Dummy blocks (no contacts) are used with an odd number of contact blocks.
- Use of early and late break contacts creates a make before break function

Part Numbers: Lamp Circuit Components

Style	Application	Part Number
Short Lamp Holder 	Used with a Half-size Transformer and one contact block	TW-LH1
Long Lamp Holder 	Used with a Full-size Transformer and two contact blocks Used w/Half-size Transformer and three contact blocks Used w/Full Voltage Adaptor and two contact blocks	TW-LH2
Lead Holder 	Used w/TW-LH2 holder when using four contact blocks	HW-LH3

Part Numbers: Transformers/Full Voltage Modules

Style	Description	Part Number	
Full Size Transformer 	Standard	120V AC	TW-T126B
		240V AC	TW-T246B
	Fingersafe	480V AC	TW-T486B
		120V AC	TW-F126B
Half Size Transformer 	120V AC	240V AC	TW-T246SB
		240V AC	TW-T246SB
	Full voltage model (use with even number of contacts) 	Standard	TW-DA1B
Fingersafe		TW-DA1FB	
Full voltage model (use with odd number of contacts) 	Standard	HW-DA1B	
	Fingersafe	HW-DA1FB	



All Transformers step down to 6V (use 6V lamp).

Contact Arrangement Charts

How to Read Contact Arrangement Charts

To determine contact block mounting position, first make sure the selector switch is oriented as shown on the right

Switches & Pilot Devices

A3

Contact Arrangement
Type and quantity of switch contacts

Circuit Number
* N/D = No designation required

Contact Block Mounting Position
Position or mounting contact blocks on operator

Operator Position
Truth table indicates the operating position of contact block when operator is switched to that position.

Contact Block Part Number
Part number to use when ordering sub-assembly contact blocks, as required for use with corresponding mounting position

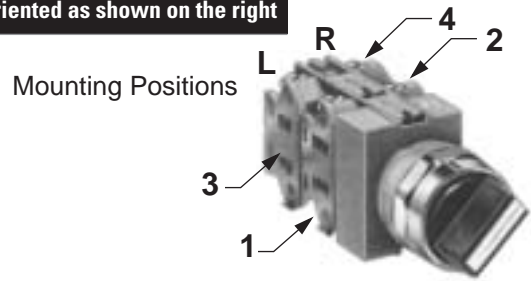

Contact Arrangement Chart: 2-Position Selector Switches

Style	Contact	Circuit Number	Mounting Position	Operator Position		Contact Block Part Number	Description	Operator Part Number		
				L	R			Maintained	Spring Ret. from Rt.	Spring Ret. from Lt.
1NO	N/D		1	0	X	HW-C10	Knob/Lever Key Illuminated Knob	ASW200 ASW2K00 ASLW200	ASW2100 ASW21K00 ASLW2100	ASW2200 ASW22K00 ASLW2200
			2	0	0	TW-DB				
1NC	116		1	X	0	HW-C01	Knob/Lever Key Illuminated Knob	ASW200 ASW2K00 ASLW200	ASW2100 ASW21K00 ASLW2100	ASW2200 ASW22K00 ASLW2200
			2	0	0	TW-DB				
1NO 1NC	N/D		1	0	X	HW-C10	Knob/Lever Key Illuminated Knob	ASW200 ASW2K00 ASLW200	ASW2100 ASW21K00 ASLW2100	ASW2200 ASW22K00 ASLW2200
			2	X	0	HW-C01				
	103		1	X	0	HW-C01	Knob/Lever Key Illuminated Knob	ASW200 ASW2K00 ASLW200	ASW2100 ASW21K00 ASLW2100	ASW2200 ASW22K00 ASLW2200
			2	0	X	HW-C10				
1NO-EM 1NC-LB	600		1	0	X	HW-C10R	Knob/Lever Key Illuminated Knob	ASW200 ASW2K00 ASLW200	ASW2100 ASW21K00 ASLW2100	ASW2200 ASW22K00 ASLW2200
			2	X	0	HW-C01R				
	601		1	X	0	HW-C01R	Knob/Lever Key Illuminated Knob	ASW200 ASW2K00 ASLW200	ASW2100 ASW21K00 ASLW2100	ASW2200 ASW22K00 ASLW2200
			2	0	X	HW-C10R				
2NO	N/D		1	0	X	HW-C10	Knob/Lever Key Illuminated Knob	ASW200 ASW2K00 ASLW200	ASW2100 ASW21K00 ASLW2100	ASW2200 ASW22K00 ASLW2200
			2	0	X	HW-C10				
2NC	104		1	X	0	HW-C01	Knob/Lever Key Illuminated Knob	ASW200 ASW2K00 ASLW200	ASW2100 ASW21K00 ASLW2100	ASW2200 ASW22K00 ASLW2200
			2	X	0	HW-C01				
2NO 2NC	N/D		1	0	X	HW-C10	Knob/Lever Key Illuminated Knob	ASW200 ASW2K00 ASLW200	ASW2100 ASW21K00 ASLW2100	ASW2200 ASW22K00 ASLW2200
			2	X	0	HW-C01				
			3	0	X	HW-C10				
			4	X	0	HW-C01				
	111		1	0	X	HW-C10	Knob/Lever Key Illuminated Knob	ASW200 ASW2K00 ASLW200	ASW2100 ASW21K00 ASLW2100	ASW2200 ASW22K00 ASLW2200
			2	0	X	HW-C10				
			3	X	0	HW-C01				
			4	X	0	HW-C01				

1. NO-EM, NC-LB = Early Make, Late Break.
 N/D = No circuit number designation required in assembled selector switch part number.
 2. X = On (closed contacts) O = Off (Open contacts)

Contact Arrangement Chart: 3-Position Selector Switches

Style		Mounting Position	Operator Position			Contact Block Part Number	Description	Operator Part Number				
Contact	Circuit Number		L	C	R			Maintained	Spring Ret. from Rt.	Spring Ret. from Lt.	Two-Way	
1NO 1NC	202	1	X	0	0	HW-C10	Knob/Lever Key Illuminated Knob	ASW300-1 ASW3K00-1 ASLW300-1	ASW3100-1 ASW31K00-1 ASLW3100-1	ASW3200-1 ASW32K00-1 ASLW3200-1	ASW3300-1 ASW33K00-1 ASLW3200-1	
		2	X	X	0	HW-C01						
	203	1	0	X	X	HW-C01	Knob/Lever Key Illuminated Knob	ASW300-1 ASW3K00-1 ASLW300-1	ASW3100-1 ASW31K00-1 ASLW3100-1	ASW3200-1 ASW32K00-1 ASLW3200-1	ASW3300-1 ASW33K00-1 ASLW3200-1	
		2	0	0	X	HW-C10						
	302	1	X	0	X	HW-C10	Knob/Lever Key Illuminated Knob	ASW300-2 ASW3K00-2 ASLW300-2	ASW3100-2 ASW31K00-2 ASLW3100-2	ASW3200-2 ASW32K00-2 ASLW3200-2	ASW3300-2 ASW33K00-2 ASLW3200-2	
		2	X	X	0	HW-C01						
	303	1	0	X	0	HW-C01	Knob/Lever Key Illuminated Knob	ASW300-2 ASW3K00-2 ASLW300-2	ASW3100-2 ASW31K00-2 ASLW3100-2	ASW3200-2 ASW32K00-2 ASLW3200-2	ASW3300-2 ASW33K00-2 ASLW3200-2	
		2	0	0	X	HW-C10						
	2NO	N/D	1	X	0	0	HW-C10	Knob/Lever Key Illuminated Knob	ASW300-1 ASW3K00-1 ASLW300-1	ASW3100-1 ASW31K00-1 ASLW3100-1	ASW3200-1 ASW32K00-1 ASLW3200-1	ASW3300-1 ASW33K00-1 ASLW3200-1
			2	0	0	X	HW-C10					
301		1	X	0	X	HW-C10	Knob/Lever Key Illuminated Knob	ASW300-2 ASW3K00-2 ASLW300-2	ASW3100-2 ASW31K00-2 ASLW3100-2	ASW3200-2 ASW32K00-2 ASLW3200-2	ASW3300-2 ASW33K00-2 ASLW3200-2	
		2	0	0	X	HW-C10						
2NC	304	1	0	X	0	HW-C01	Knob/Lever Key Illuminated Knob	ASW300-2 ASW3K00-2 ASLW300-2	ASW3100-2 ASW31K00-2 ASLW3100-2	ASW3200-2 ASW32K00-2 ASLW3200-2	ASW3300-2 ASW33K00-2 ASLW3200-2	
		2	X	X	0	HW-C01						
	N/D	1	0	X	X	HW-C01	Knob/Lever Key Illuminated Knob	ASW300-1 ASW3K00-1 ASLW300-1	ASW3100-1 ASW31K00-1 ASLW3100-1	ASW3200-1 ASW32K00-1 ASLW3200-1	ASW3300-1 ASW33K00-1 ASLW3200-1	
		2	X	X	0	HW-C01						
2NO 2NC	N/D	1	X	0	0	HW-C10	Knob/Lever Key Illuminated Knob	ASW300-1 ASW3K00-1 ASLW300-1	ASW3100-1 ASW31K00-1 ASLW3100-1	ASW3200-1 ASW32K00-1 ASLW3200-1	ASW3300-1 ASW33K00-1 ASLW3200-1	
		2	0	0	X	HW-C10						
		3	0	X	X	HW-C01						
		4	X	X	0	HW-C01						
	210	1	0	X	X	HW-C01	Knob/Lever Key Illuminated Knob	ASW300-1 ASW3K00-1 ASLW300-1	ASW3100-1 ASW31K00-1 ASLW3100-1	ASW3200-1 ASW32K00-1 ASLW3200-1	ASW3300-1 ASW33K00-1 ASLW3200-1	
		2	0	0	X	HW-C10						
		3	0	X	X	HW-C01						
		4	0	0	X	HW-C10						
	308	1	X	0	X	HW-C10	Knob/Lever Key Illuminated Knob	ASW300-2 ASW3K00-2 ASLW300-2	ASW3100-2 ASW31K00-2 ASLW3100-2	ASW3200-2 ASW32K00-2 ASLW3200-2	ASW3300-2 ASW33K00-2 ASLW3200-2	
		2	X	X	0	HW-C01						
		3	X	0	X	HW-C10						
		4	X	X	0	HW-C01						
	309	1	X	0	X	HW-C10	Knob/Lever Key Illuminated Knob	ASW300-2 ASW3K00-2 ASLW300-2	ASW3100-2 ASW31K00-2 ASLW3100-2	ASW3200-2 ASW32K00-2 ASLW3200-2	ASW3300-2 ASW33K00-2 ASLW3200-2	
		2	X	X	0	HW-C01						
		3	0	X	0	HW-C01						
		4	0	0	X	HW-C10						
310	1	0	X	0	HW-C01	Knob/Lever Key Illuminated Knob	ASW300-2 ASW3K00-2 ASLW300-2	ASW3100-2 ASW31K00-2 ASLW3100-2	ASW3200-2 ASW32K00-2 ASLW3200-2	ASW3300-2 ASW33K00-2 ASLW3200-2		
	2	0	0	X	HW-C10							
	3	0	X	0	HW-C01							
	4	0	0	X	HW-C10							
4NO	N/D	1	X	0	0	HW-C10	Knob/Lever Key Illuminated Knob	ASW300-1 ASW3K00-1 ASLW300-1	ASW3100-1 ASW31K00-1 ASLW3100-1	ASW3200-1 ASW32K00-1 ASLW3200-1	ASW3300-1 ASW33K00-1 ASLW3200-1	
		2	0	0	X	HW-C10						
		3	X	0	0	HW-C10						
		4	0	0	X	HW-C10						
	305	1	X	0	X	HW-C10	Knob/Lever Key Illuminated Knob	ASW300-2 ASW3K00-2 ASLW300-2	ASW3100-2 ASW31K00-2 ASLW3100-2	ASW3200-2 ASW32K00-2 ASLW3200-2	ASW3300-2 ASW33K00-2 ASLW3200-2	
		2	0	0	X	HW-C10						
		3	X	0	X	HW-C10						
		4	0	0	X	HW-C10						
4NC	N/D	1	0	X	X	HW-C01	Knob/Lever Key Illuminated Knob	ASW300-1 ASW3K00-1 ASLW300-1	ASW3100-1 ASW31K00-1 ASLW3100-1	ASW3200-1 ASW32K00-1 ASLW3200-1	ASW3300-1 ASW33K00-1 ASLW3200-1	
		2	X	X	0	HW-C01						
		3	0	X	X	HW-C01						
		4	X	X	0	HW-C01						
	314	1	0	X	0	HW-C01	Knob/Lever Key Illuminated Knob	ASW300-2 ASW3K00-2 ASLW300-2	ASW3100-2 ASW31K00-2 ASLW3100-2	ASW3200-2 ASW32K00-2 ASLW3200-2	ASW3300-2 ASW33K00-2 ASLW3200-2	
		2	X	X	0	HW-C01						
		3	0	X	0	HW-C01						
		4	X	X	0	HW-C01						

A3

Switches & Pilot Devices



- Each operator sub-assembly is available as a "-1" and a "-2" for 3-position selector switches. The internal cam of a "-1" is different from that of a "-2". This results in designated combinations of open and closed contacts in the various operator positions.
- N/D = No circuit number designation required in assembled part number.
- X = On (closed contacts) O = Off (open contacts) X-X Overlapping contacts remain on (closed) when switch is moved between these two positions.

Custom Selector Switch Building Guide

To build a custom selector switch, follow these steps.

Step 1: How many positions of the switch are needed?

A3

of positions
(2, 3, 4, 5)

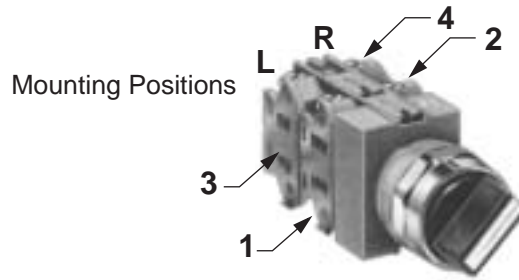

Step 2: How many contacts should there be?

of isolated contacts
(maximum 6)

Step 3: Fill in the Truth Table

(X = closed, 0 = open)

		Knob Position				
		1	2	3	4	5
C o n t a c t s	1					
	2					
	3					
	4					
	5					
	6					

Step 4: If building a 2 position selector, skip this step. (2 position selectors have only one cam)

If building a 3, 4, or 5 position selector, determine appropriate cam as follows:

- Look at Row 1 from above table and locate an identical row in the operator truth tables (See next page).
- Repeat for all rows. The user must find one operator that contains all rows from above table.
- Record the operator cam version.

Operator CAM Version
(-1, -2, -3 for 3 position)
("blank", -1 for 4 position)
("blank", -1 for 5 position)

Step 5: Build by placing appropriate contact in appropriate mounting position for each desired row on operator cam truth table. "L" and "R" refer to mounting on left or right side of operator as viewed from the front of the panel.

Step 6: Develop an assembly part number (if necessary) as follows: follow standard numbering nomenclature for selector switches (see pages A3-142 or A3-146). In place of the "Circuit Number" indicate the cam number and contact arrangement as such ASW322-3-OELCSS, where "3" is the cam number, and contact arrangement "OELCXX" calls out individual contact mounting locations in order (see diagram above). O=NO, C=NC, E=NO-EM, L=NC-LB, X= no contact. Part number must designate all 6 possible mounting locations.

Caution: Before putting any custom selector switch into use, the user should use an ohmmeter to test for desired performance.



1. For Operator Truth Tables, see next page.
2. For examples of how to assemble selector switches, see A3-82.

Operator Truth Tables

Use the following tables to build custom selector switches.

2 Position Selector Switches

Contact	Mounting Position	Operator Position	
		Left	Right
HW-C10 (NO)	L	0	X
	R	0	X
HW-C01 (NC)	L	X	0
	R	X	0
HW-C10R (NO-EM)	L	0	X
	R	0	X
HW-C01R (NC-LB)	L	X	0
	R	X	0

**ASW200
ASLW200
ASW2K00**

4 Position Selector Switches

Contact	Mounting Position	Operator Position			
		1	2	3	4
HW-C10 (NO)	L	X	0	0	0
	R	0	X	0	0
HW-C01 (NC)	L	0	X	X	X
	R	X	0	X	X
HW-C10R (NO-EM)	L	X	0	0	0
	R	0	X	0	0
HW-C01R (NC-LB)	L	0	X	X	X
	R	X	0	X	X

ASW400

3 Position Selector Switches

Contact	Mounting Position	Operator Position		
		Left	Center	Right
HW-C10 (NO)	L	X	0	0
	R	0	0	X
HW-C01 (NC)	L	0	X	X
	R	X	X	0
HW-C10R (NO-EM)	L	X	0	0
	R	0	0	X
HW-C01R (NC-LB)	L	0	X	X
	R	X	X	0

**ASW300-1
ASW3K00-1
ASLW300-1**

Contact	Mounting Position	Operator Position			
		1	2	3	4
HW-C10 (NO)	L	X	0	0	0
	R	0	0	0	X
HW-C01 (NC)	L	0	0	X	0
	R	0	X	0	0
HW-C10R (NO-EM)	L	X	X	0	X
	R	X	0	X	X
HW-C01R (NC-LB)	L	0	X	X	X
	R	X	X	X	0

ASW400-1

Contact	Mounting Position	Operator Position		
		Left	Center	Right
HW-C10 (NO)	L	X	0	X
	R	0	0	X
HW-C01 (NC)	L	0	X	0
	R	X	X	0
HW-C10R (NO-EM)	L	X	0	X
	R	0	0	X
HW-C01R (NC-LB)	L	0	X	0
	R	X	X	0

**ASW300-2
ASW3K00-2
ASLW300-2**

5 Position Selector Switches

Contact	Mounting Position	Operator Position				
		1	2	3	4	5
HW-C10 (NO)	L	X	0	0	0	0
	R	0	X	0	0	0
HW-C01 (NC)	L	0	0	X	X	X
	R	0	0	0	X	X
HW-C10R (NO-EM)	L	X	0	0	0	0
	R	0	X	0	0	0
HW-C01R (NC-LB)	L	0	X	X	X	X
	R	X	0	X	X	X

ASW500

Contact	Mounting Position	Operator Position		
		Left	Center	Right
HW-C10 (NO)	L	X	0	0
	R	0	0	X
HW-C01 (NC)	L	0	X	0
	R	0	X	0
HW-C10R (NO-EM)	L	X	0	X
	R	X	0	X
HW-C01R (NC-LB)	L	0	X	X
	R	X	X	0

**ASW300-3
ASW3K00-3
ASLW300-3**

Contact	Mounting Position	Operator Position				
		1	2	3	4	5
HW-C10 (NO)	L	X	0	0	0	0
	R	0	0	0	0	X
HW-C01 (NC)	L	0	0	0	X	0
	R	0	X	0	0	0
HW-C10R (NO-EM)	L	X	X	X	0	X
	R	X	0	X	X	X
HW-C01R (NC-LB)	L	0	X	X	X	X
	R	X	X	X	X	0

ASW500-1

Nameplates — TW Series

Part Numbers: Nameplates

A3

Switches & Pilot Devices

	NWAL	NWAQL	NWAS	EMERGENCY STOP
	Part Number	Part Number	Part Number	Part Number
Nameplate (blank)	NWAL-OB (black) NWAL-OR (red)	NWAQL-OB (black) NWAQL-OR (red)	NWAS-OB	NWAR-0
Nameplate (engraved)	NWAL-①	NWAQL-①	NWAS-①	NWAR-27 [†]

1. In place of ①, insert either the Standard Legend Code from table below or custom engraving delimited by “ “.
2. Standard engravings are available at no charge.
3. NWAR-27 comes marked “Emergency Stop” as shown in drawing.

Standard Legend Codes

Pushbuttons				Pushbuttons/Selector Switches				Selector Switches	
Legend	Code	Legend	Code	Legend	Code	Legend	Code	Legend	Code
AUTO	101	OPEN	116	AUTO-MAN	201			AUTO-MAN-OFF	301
CLOSE	102	OUT	117	CLOSE-OPEN	202			AUTO-OFF-MAN	302
DOWN	103	RAISE	118	DOWN-UP	203			CLOSE-OFF-OPEN	303
EMERG.STOP*	104	RESET	119	FAST-SLOW	204			DOWN-OFF-SLOW	304
FAST	105	REVERSE	120	FOR-REV	205	REV-FOR	216	FAST-OFF-SLOW	305
FORWARD	106	RUN	121	HAND-AUTO	206	RUN-JOG	217	FOR-OFF-REV	306
HAND	107	SLOW	122	HIGH-LOW	207	RUN-SAFE	218	LEFT-OFF-RIGHT	307
HIGH	108	START	123	JOG-RUN	208	SAFE-RUN	219	LOWER-OFF-RAISE	308
IN	109	STOP*	124	LEFT-RIGHT	209	SLOW-FAST	220	OFF-MAN-AUTO	309
INCH	110	STOP	125	LOWER-RAISE	210	START-STOP	221	OFF-SLOW-FAST	310
JOG	111	TEST	126	MAN-AUTO	211	STOP-START	222	OFF-1-2	311
LOW	112	UP	127	OFF-ON	212	UP-DOWN	223	OPEN-OFF-CLOSE	312
LOWER	113	I (Int'l On)	150	ON-OFF	213			SLOW-OFF-FAST	313
OFF	114	O (Int'l Off)	151	OPEN-CLOSE	214			SUMMER-OFF-WINTER	314
ON	115	EMO	152	RAISE-LOWER	215			UP-OFF-DOWN	315
								1-OFF-2	316
								HAND-OFF-AUTO	317

1. To order engraved nameplates, add legend code to nameplate part number.
Character height based on the number of characters and size of nameplate. Standard character size is 3/16".
2. Nameplates with standard legends are the same list price as blank nameplates.
3. * Available in red as standard.

Nameplate Order Form on next page.

Custom Engraved Nameplates Order Form — TW Series

Copy this order form and use it to specify Letter Height, Custom Engravings, Location of Engraving on Nameplate, and Quantity Desired. To insure engraving accuracy, fax it to your IDEC representative, or Distributor.

Your Company Name: _____
 Your Name: _____
 Telephone: _____
 Fax & Email: _____

IDEC Rep/Distributor Contact: _____
 PO number (if known): _____
 IDEC Rep/Distributor Phone: _____
 IDEC Rep/Distributor Fax & Email: _____

A3

Switches & Pilot Devices

NWAL

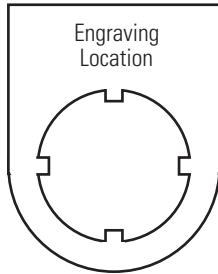

Step 1. Choose Letter Size - 7/64" or 1/8".
 Check the box for the letter size you want. Then write your lettering in box below checkboxes. Note: 1/8" size letters cannot exceed 9 characters.

7/64" Letter Size 11 characters max (for 7/64" size letters)

1/8" Letter Size 9 characters max (for 1/8" size letters)

Step 2. Specify Quantity.
 Enter the number of nameplates desired in the box on the right.

Qty

1	2	3	4	5	6	7	8	9	10	11	

Sample Letter Sizes
 7/64" Letters: A B C D
 1/8" Letters: A B C D

NWAQL

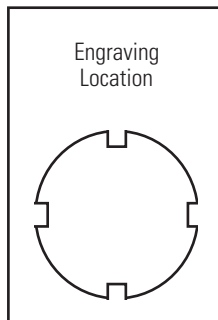

Step 1. Choose Letter Size - 7/64" or 1/8".
 Check the box for the letter size you want. Then write your lettering in box below checkboxes. Note: 1/8" size letters cannot exceed 9 characters.

7/64" Letter Size 11 characters max (for 7/64" size letters)

1/8" Letter Size 9 characters max (for 1/8" size letters)

Step 2. Specify Quantity.
 Enter the number of nameplates desired in the box on the right.

Qty

1	2	3	4	5	6	7	8	9	10	11	

Sample Letter Sizes
 7/64" Letters: A B C D
 1/8" Letters: A B C D

NWAS

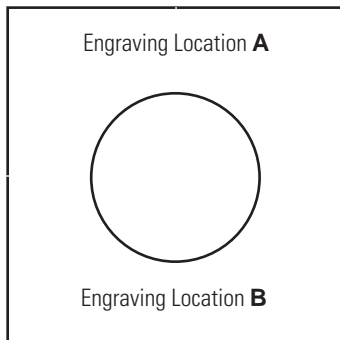

Step 1. Choose Letter Size - 1/8" or 3/32".
 Check the box for the letter size you want. Then write your lettering in box below checkboxes. Note: 1/8" size letters cannot exceed 14 characters.

3/32" Letter Size 20 characters maximum (for 3/32" size letters)

1/8" Letter Size 14 characters maximum (for 1/8" size letters)

Step 2. Specify Quantity.
 Enter the number of nameplates desired in box on the right.

Qty

Step 3. Specify Location.
 Enter the location of engraving (A or B), in box on the right.

Location

Sample Letter Sizes
 3/32" Letters: A B C D
 1/8" Letters: A B C D

1	2	3	4	5	6	7	8	9	10	11	12	13	14	15	16	17	18	19	20	

Accessories — TW Series

Part Numbers: TW Series Accessories





	Appearance	Description/Usage	Part Number
A3 Lamp Removal Tool		Rubber tool used to install LED's and incandescent lamps	OR-55
Contact Block Remover		Used to remove contact blocks, transformers, lenses, and adaptors. Can also be used to determine panel thickness adjustment.	TW-KC1
Nut Locking Wrench		Used in OR-14 locking wrench to tighten locking nuts inside square bezel	TW-KQ2
Metal Bezel		Chrome plated bezels tighten onto operator (replacement for damaged bezels)	Standard octagonal units (chrome-pl.) AW-R8
			Full shroud octagonal units (chrome-pl.) AW-RF8
			Full shroud (chrome plated) mushroom head units Ø 40mm AW-G4
Plastic Bezel		Black plastic bezels for square buttons (replacement for damaged bezels)	Round flush units (black plastic) AW-RP1B
			Round extended units (black plastic) AW-FP1B
			Square units (black plastic) AW-Q1B
			Square bezel with round hole (black plastic) AW-H1B
			Square units with full shroud (black plastic) AW-QF1B
Boot/Cover		Used to cover and protect pushbuttons	Waterproof lens cover for square pilot lights APW00LN
			Waterproof lens cover for square illuminated buttons APW00L
			Clear boot for round flush units (EPR) OC-31
			Clear boot for round extended units (EPR) OC-32
			In place of asterisk, specify Rubber Boot color: B (black), G (green), R (red), Y (yellow) - (nitril rubber) OCW-11
Anti-Rotation Ring		Ring to prevent operator base from rotating in the mounting hole. Used when nameplate is not used	OGL-31
Mounting Hole Plug		Black rubber plug fills unused mounting holes in panel.	OB-31
Metallic Mounting Hole Plug		For plugging unused mounting holes in the panel. Tighten the attached locking ring to a torque of 12 kfg-cm maximum Degree of protection: IP66	LW9Z-BM
Replacement Keys		Pair of keys (#0)	TW-SK



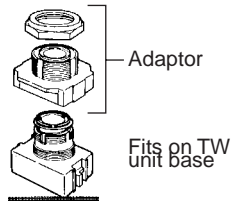

For information on replacement engraving inserts, see page A3-164.

Accessories con't

Part Numbers: TW Series Accessories

Appearance	Description/Usage		Part Number
 <p>Metal Button Guard</p>	Used on flush buttons to prevent inadvertent actuation		OLW-C
 <p>Terminal Tab Adaptor</p>	Quick- connect terminals	#250 (17/64" x 3/64") single tab	TW-FA1
 <p>Lock-out Adaptor</p>	Used to provide lock-out protection for pushbuttons and knob selector switches: • Up to Ø 40mm mushroom head size (Padlock not included.)		HW9Z-KL1
 <p>TW to TWTD Adaptor</p> <p>Adaptor</p> <p>Fits on TW unit base</p>	Used to mount TW series control unit (except square units) Ø 7/8" (22mm) into a Ø 1-13/64" (30mm) panel cut-out. Includes 2 pieces shown on the right		TWN-A1R8
 <p>Replacement Marking Plates</p>		Round Pushbutton (Ø14mm)	ALW2B
		Round Pilot Light (Ø 14mm)	APW2B
		Mushroom Pushbutton (Ø 14mm)	ALW3B
		Square Pilot Light (□ 21mm)	APQW1B
		Square Pushbutton (□ 21mm)	ALQW2B
	White plastic engraving plate for use on all illuminated units (included in each lens). May be used to capture printed mylar insert (not supplied by IDEC) under lens face.		

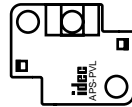
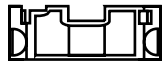
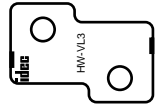
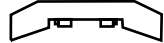
Part Numbers: Fingersafe Covers for TW Series

Appearance	Description	Used with	Part Number
	Fingersafe terminal cover, adds 6mm to overall depth	APW and UPQW full voltage pilot lights	APS-PVL
	Fingersafe terminal cover, adds 3.5mm to overall depth. One required for each contact, only for rear- most terminals	Non-illuminated pushbuttons and selectors	HW-VL2
	Fingersafe terminal cover, adds 3mm to overall depth	APW and UPQW transformer pilot lights, and illuminated pushbuttons and illuminated selectors	HW-VL3
	Fingersafe terminal cover for contacts.	Full voltage illuminated pushbuttons and selectors	HW-VL4
	Fingersafe terminal cover for full voltage adaptor, adds 3 mm to depth	Full voltage illuminated pushbuttons and selectors	HW-VL5
	Fingersafe terminal cover for half size transformer adaptor, adds 3 mm to depth	Illuminated pushbuttons and selectors	HW-VL6

A3

Switches & Pilot Devices

Dimensions — TW Series

Pushbuttons

Flush

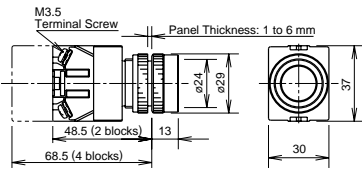

Extended

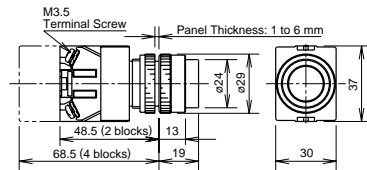

Extended with Full Shroud

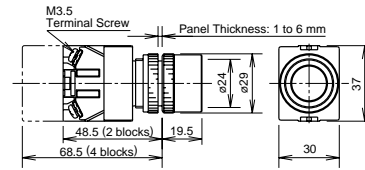

29mm Mushroom

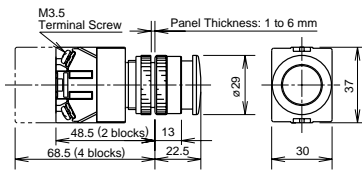

40mm Mushroom

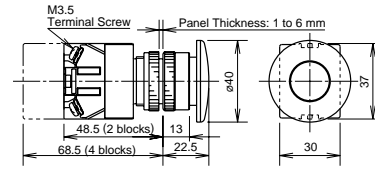

Mushroom with Full Shroud

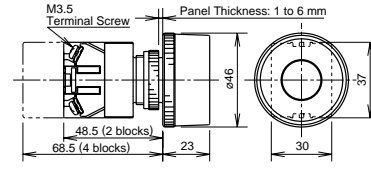

29mm Push-Lock-Turn-Reset

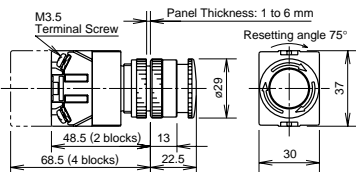

40mm Push-Lock-Turn-Reset

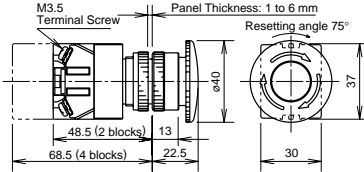

Keylock Push On/Off

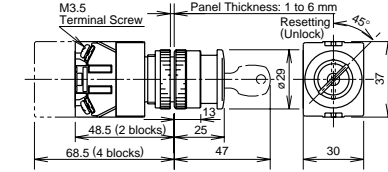

40mm Pushlock Key Reset

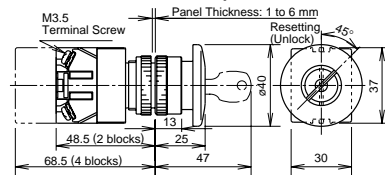

40mm Push-Pull

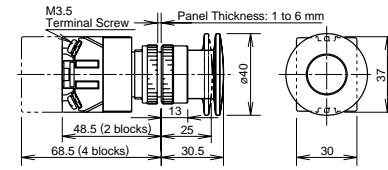

Square Flush

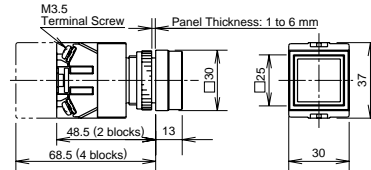

Square Extended

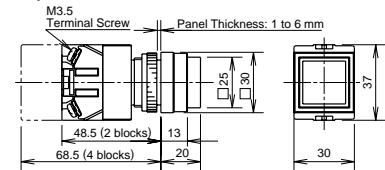

Selector Switches

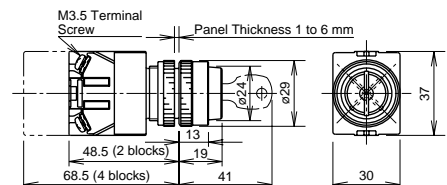
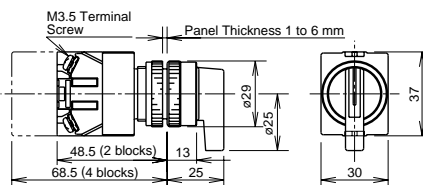
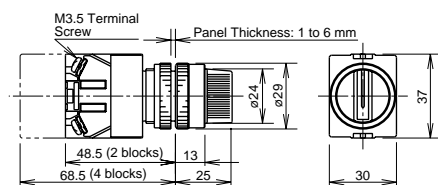

Switches & Pilot Devices

Dimensions con't

Illuminated Pushbuttons

Extended

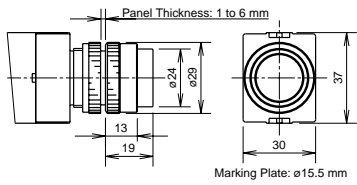

Extended with Full Shroud

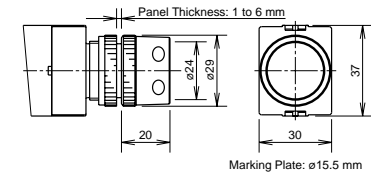

Square Extended

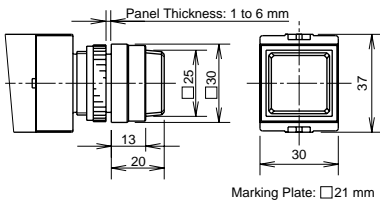

29mm Push-Turn Reset

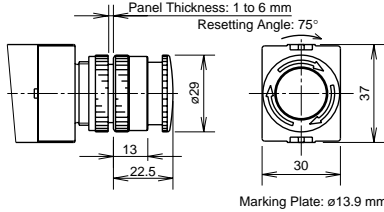

Illuminated Pushbuttons	Dimension A	Dimension B
Extended (Same for Square) w/Full Shroud	0.741" (19mm)	Ø 0.936" (Ø24mm)
	0.761" (19.5mm)	□0.975" (□25mm)
Ø 1.13" (29mm)		
Mushroom	0.858" (22mm)	Ø 1.13" (29mm)
Ø 1.56" (40mm)	0.858" (22mm)	Ø 1.56" (40mm)
Mushroom, Pushlock Turn	*0.936" (24mm)	Ø 1.56" (40mm)
Reset, Push-Pull	† 0.975" (25mm)	Ø 1.56" (40mm)



- * Dimension when operator is in reset position.
- † Dimension when operator is in pull position.

40mm Push-Turn Reset

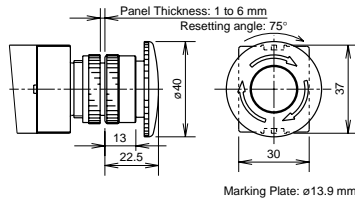

Mushroom

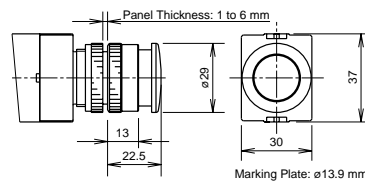

Push-Pull

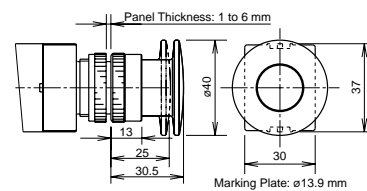

Illuminated Selector Switches

1 Contact Block with Full Voltage Adaptor

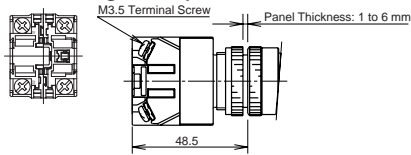

Transformer (2 blocks)

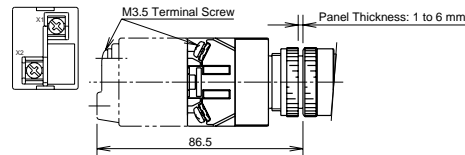

1 Contact Block with Half Size Transformer

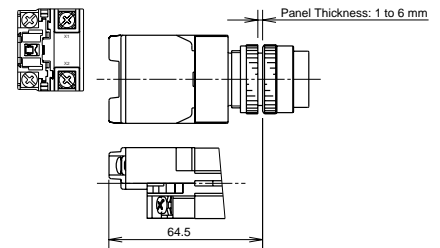

2 Contact Blocks with Full Voltage Adaptor

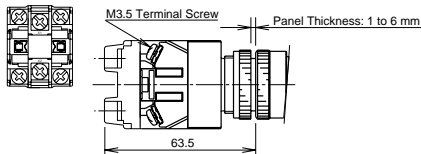

Transformer (4 blocks)

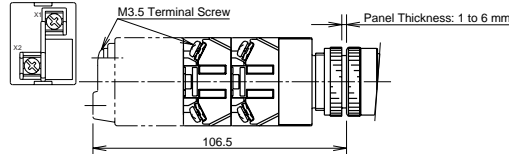

2 Contact Blocks with Half Size Transformer

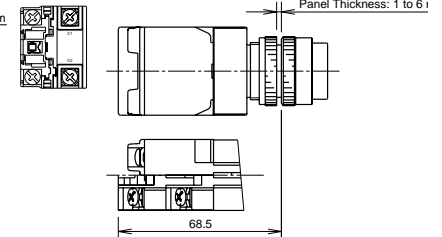

3 Contact Blocks with Full Voltage Adaptor

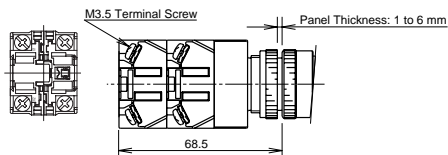

4 Contact Blocks with Full Voltage Adaptor

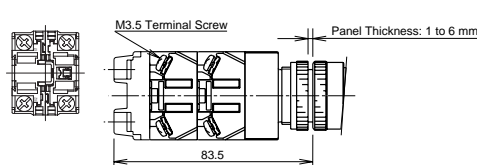

3 Contact Blocks with Half Size Transformer

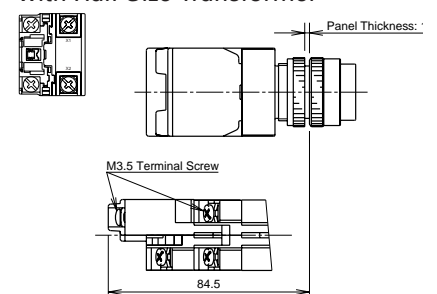

Dimensions con't

Pilot Lights

Round Flush APW1 Full Voltage

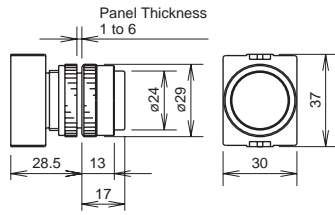

Round Flush APW1 Transformer

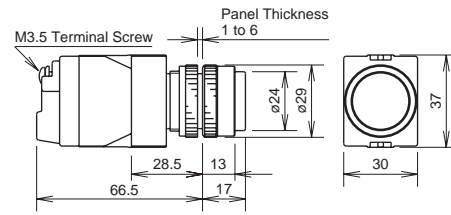

Round Flush Marking Type APW1B Full Voltage

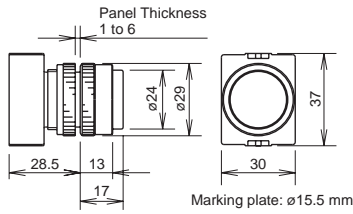

Round Flush Marking Type APW1B Transformer

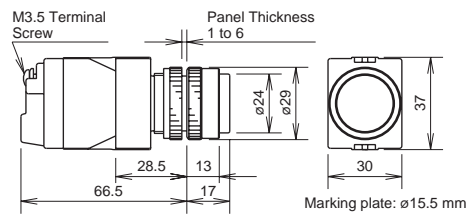

Dome APW2 Full Voltage

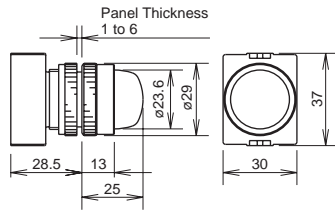

Dome APW2 Transformer

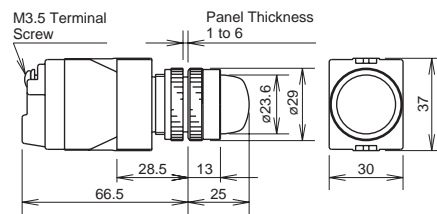

Square Flush Marking Type APQW1B Full Voltage

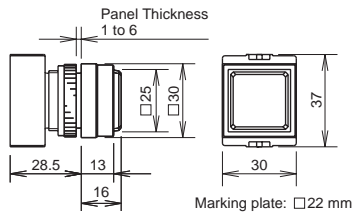

Square Flush Marking Type APQW1B Transformer

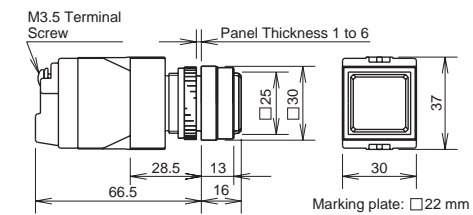

Illuminated Selector Switches

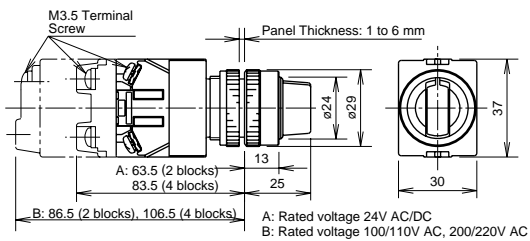

A3

Switches & Pilot Devices

Dimensions con't

Panel Cut-Out

Diagram	Part	Dimensions			
		A	B	C	D
	Pushbuttons	Ø 0.137" (3.5mm)	1.95" (50mm); 1.76" (45mm) minimum	Ø 0.878" (22.3mm)	1.17" (30mm) Std. Octagonal > 1.56" (40mm) Large Mushroom
	Pilot Light				
	Illuminated Pushbutton				
	Selector Switches				
	Illuminated Selector Switches				1.17" (30mm) *See note.



- The Ø 0.137" (Ø 3.5mm) recess is necessary when either the nameplate or anti-rotation ring is used.
- * >1.404" (36mm) for 2- or 3-position.
>1.95" (50mm) for 4- or 5-position.

Accessory Dimensions

OGL-31
Anti-Rotation Ring

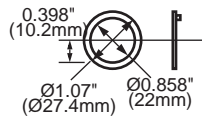

OLW-C
Metal Button Guard

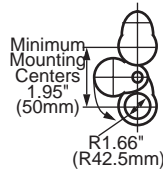

OCW-11
Pushbutton Rubber Boot

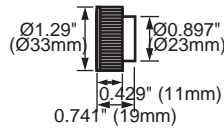

OB-31
Mounting Hole Rubber Plug

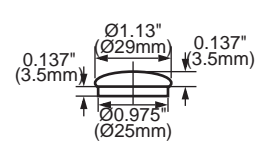

HW9Z-KL1 (TW)
Lock-out Adaptor

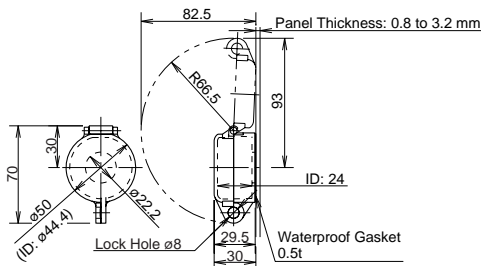

AW-RP1B
Round Plastic Bezel

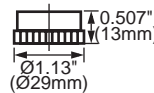

AW-FP1B
Round Plastic w/Full Shroud

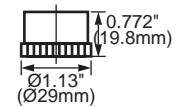

AW-QF1B
Square Full Shroud

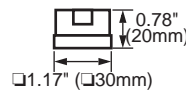

AW-H1B
Square Bezel w/ Round Hole

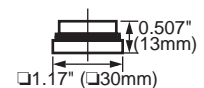

Dimensions con't

Finger-Safe Cover Dimensions

A3

Switches & Pilot Devices

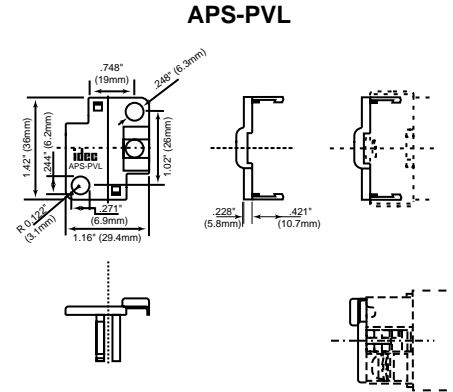
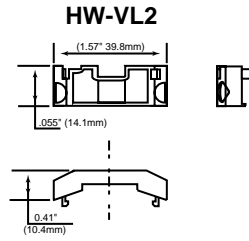
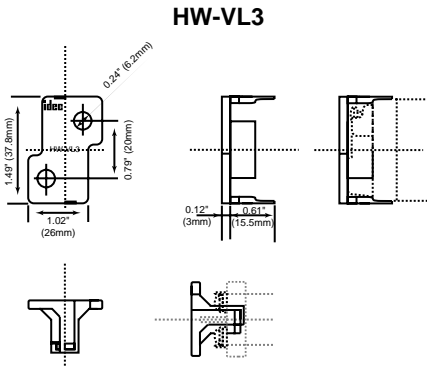
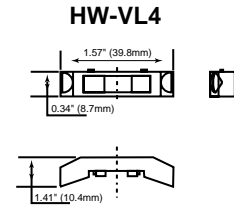
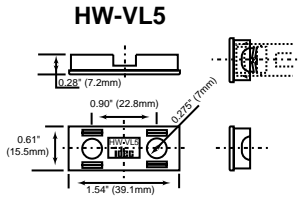
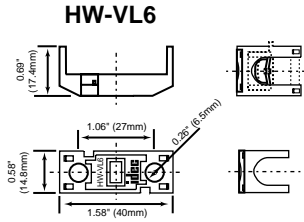

Component Construction & Instructions — TW Series

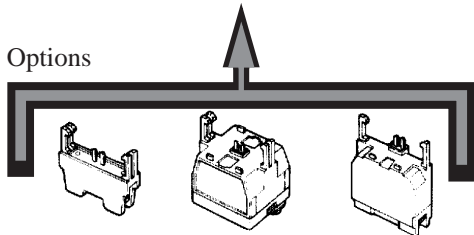
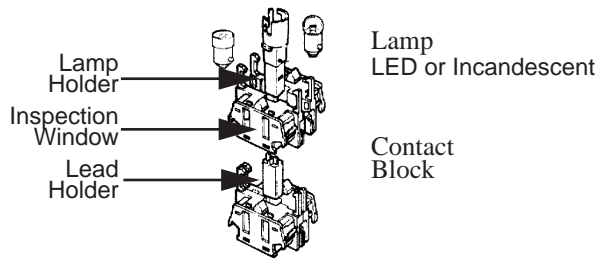
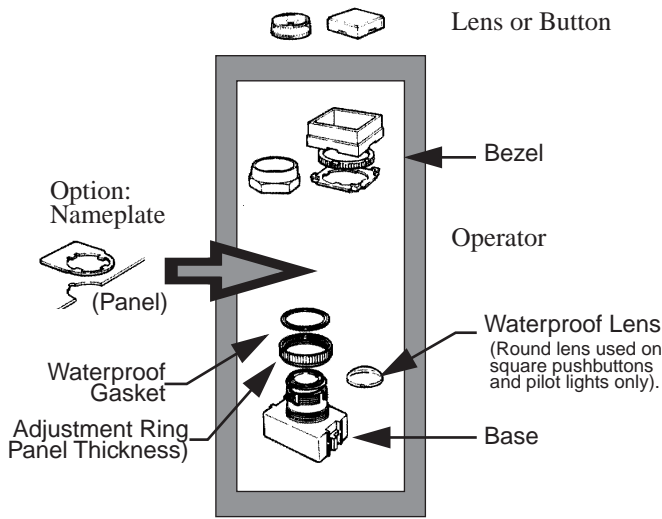

Full Voltage Adaptor:
Used with full voltage LED or incandescent.

Full-Size Transformer:
Used with incandescent/LED – even number of contact blocks.

Half-Size Transformer:
Used with incandescent – odd number of contact blocks.

Instructions for Switches and Pilot Devices

TW Series: Adjustment for Panel Thickness

The panel thickness ring provides adjustment from 0.04" to 0.24" (1 to 6mm) in 0.004" (0.1mm) increments. Rotate the ring until the markings around the periphery are aligned for the desired thickness, as shown below.

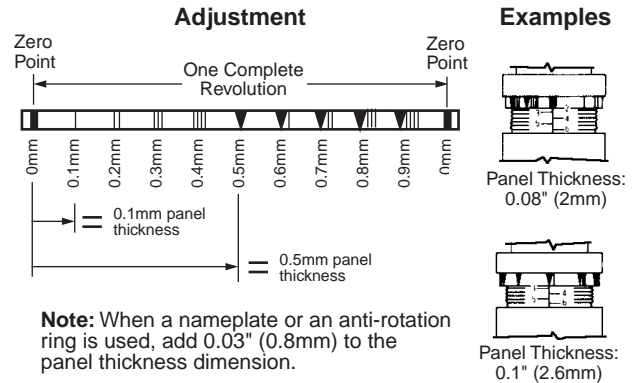

Note: When a nameplate or an anti-rotation ring is used, add 0.03" (0.8mm) to the panel thickness dimension.

An adjustment for panel thicknesses shown below can be made quickly by using the contact block remover tool.

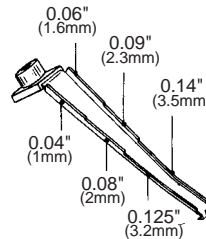

Instructions con't

Pilot Lights and Pushbuttons

A3

IMPORTANT: Install the body of the TW control unit with the panel thickness scale facing up.

Octagonal and Round Bezels

Octagonal and round bezels screw into the operator. Use the locking ring wrench (optional) for secure tightening and easy removal. Round flush and extended buttons snap onto the operator base. Mushroom buttons screw onto the operator base.

Every round lens can be used with or without legend markings. Engraving can be done on a white translucent plate which is placed in the lens, or clear mylar can be printed and placed in the lens.

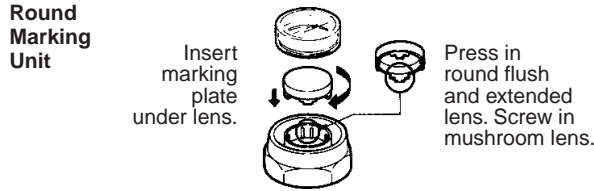

Square Bezels

Square bezels are installed in a 3-step procedure. First install the base plate from the front. Then install the lock nut using the nut locking wrench (optional). Finally, install the square bezel, which snap-fits onto the base plate. Square buttons also snap onto the operator base.

Every square lens can be used with or without legend markings. Engraving can be done on a white translucent plate which is placed in the lens, or clear mylar can be printed and placed in the lens. Square units include a round waterproof lens which screws into the operator. The square outer lens snaps on.

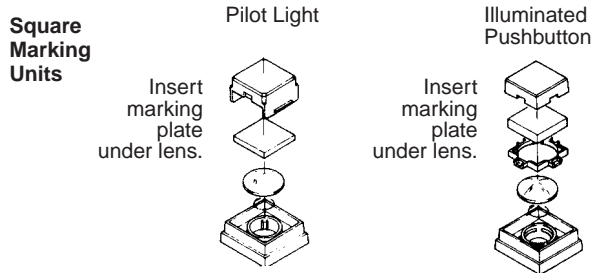

To remove square lens from operator, place a screwdriver under the indentation on the side of the lens. To remove the marking plate, place a screwdriver under the indentation and lift out the plate. The lens retainer can be removed by pressing a 3/16" screwdriver into one of the recesses.



Marking Plate Engraving Area

Shape	Engraving Area	Used With	Part Number
Round	Ø 0.55" (14mm)	Illuminated pushbuttons	ALW2B
	Ø 0.55" (14mm)	Pilot lights	APW2B
Mushroom	Ø 0.55" (14mm)	Illuminated mushroom	ALW3B
Square	□ 0.83" (21mm)	Square pilot lights	APQW1B
Square	□ 0.83" (21mm)	Square illuminated pushbuttons	ALQW2B

Instructions con't

Selector Switches

The operator shaft of each unit has a recess to identify in which direction to install the handle. Align the handle with the recess. Press color insert (TW-HC1) into the handle and then press handle into the operator, as shown below.

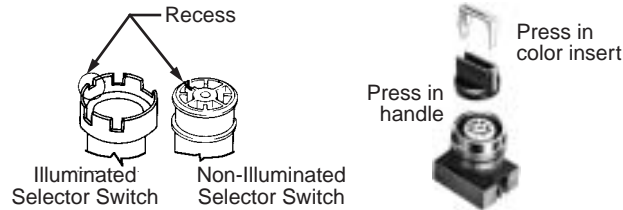

Remove color insert before pulling out the handle.

Standard Operating Positions

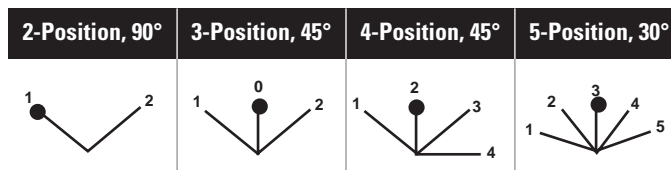

Positions:

Non-illuminated 3-Position Operators

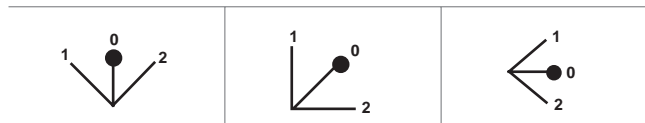

Installation

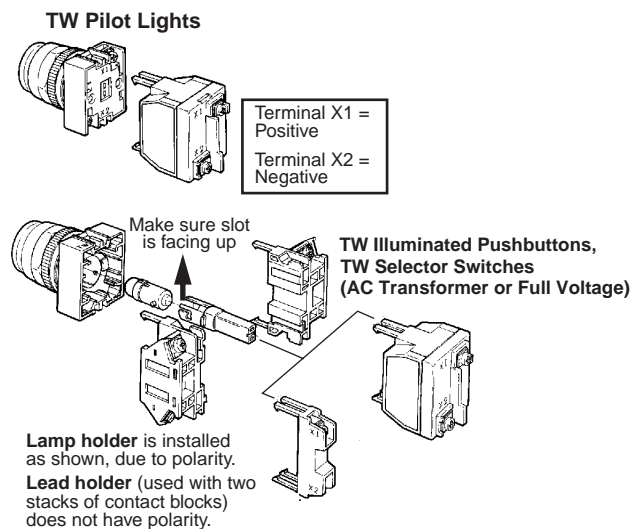

Installation of LED Illuminated Units

AC transformers are recommended for use in areas subjected to inductive noise. When using full voltage types, install a protection diode as shown below. (Diode with DC power supply to protect against surges and noise.)



Make sure that LED illuminated units are installed with correct polarity, as indicated at the terminals.