

Amphenol

Interconnection Accessories

5001 Backshell Series

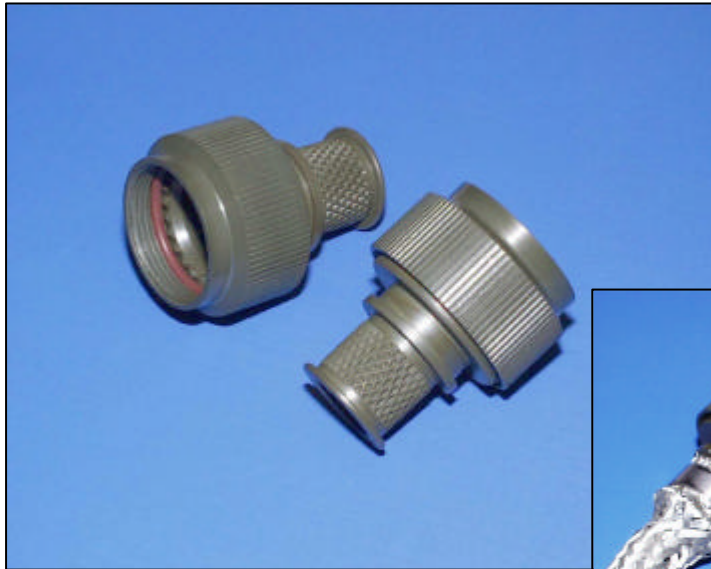

- For use on 62GB, MIL-C-26482, BS9522, F0017 connector ranges.
- MIL-C-38999 Series1, BS9522, F0029, BS9520, G0001, HE308.
- The 5001 Backshells are suitable for termination using Bandit, Zetalock and Heatshrink product.
- The 5001 Backshell is designed to give 360° screening.

Amphenol Interconnection Accessories - Amphenol Distributor:

Amphenol

Amphenol

PART NUMBER	A-THREAD	ØB MAX	ØG MAX	ØH MAX	REC HELLERMAN		SPRING REF
					BOOT 90°	BOOT STRAIGHT	
5001-08-00-00-10-AA-XX	7/16-28 UNEF	18.14	6.48	14.04	1152-4-GW24	152-42-GW24	HE 050
5001-10-00-00-10-AA-XX	9/16-24 UNEF	20.45	8.05	15.61	1154-4-GW24	154-42-GW24	HE 100
5001-12-00-00-10-AA-XX	11/16-24 UNEF	24.64	11.25	18.81	1155-4-GW24	155-42-GW24	HE 100
5001-14-00-00-10-AA-XX	13/16-20 UNEF	29.13	12.83	20.39	1155-4-GW24	155-42-GW24	HE 200
5001-16-00-00-10-AA-XX	15/16-20 UNEF	32.13	16.00	23.57	1156-4-GW24	156-42-GW24	HE 200
5001-18-00-00-10-AA-XX	1 1/16-18 UNEF	32.64	19.18	26.74	1156-4-GW24	156-42-GW24	HE 300
5001-20-00-00-10-AA-XX	1 3/16-18 UNEF	39.78	22.38	29.92	1157-4-GW24	157-43-GW24	HE 300
5001-22-00-00-10-AA-XX	1 5/16-18 UNEF	43.28	25.55	33.09	1157-4-GW24	157-43-GW24	HE 300
5001-24-00-00-10-AA-XX	1 7/16-18 UNEF	44.25	25.55	33.09	1157-4-GW24	157-43-GW24	HE 300
5001-08-06-00-10-AA-XX	7/16-28 UNEF	18.14	4.83	14.04	1152-4-GW24	152-42-GW24	HE 050
5001-10-08-00-10-AA-XX	9/16-24 UNEF	20.45	6.48	14.04	1154-4-GW24	154-42-GW24	HE 050
5001-12-10-00-10-AA-XX	11/16-24 UNEF	24.64	8.05	15.61	1155-4-GW24	155-42-GW24	HE 100
5001-14-12-00-10-AA-XX	13/16-20 UNEF	29.13	11.25	18.81	1155-4-GW24	155-42-GW24	HE 100
5001-16-14-00-10-AA-XX	15/16-20 UNEF	32.13	12.83	20.39	1156-4-GW24	156-42-GW24	HE 200
5001-18-16-00-10-AA-XX	1 1/16-18 UNEF	32.64	16.00	23.57	1156-4-GW24	156-42-GW24	HE 200
5001-20-18-00-10-AA-XX	1 3/16-18 UNEF	39.78	19.18	26.74	1157-4-GW24	157-43-GW24	HE 300
5001-22-20-00-10-AA-XX	1 5/16-18 UNEF	43.28	22.38	29.92	1157-4-GW24	157-43-GW24	HE 300
5001-24-22-00-10-AA-XX	1 7/16-18 UNEF	44.25	25.55	33.09	1157-4-GW24	157-43-GW24	HE 300

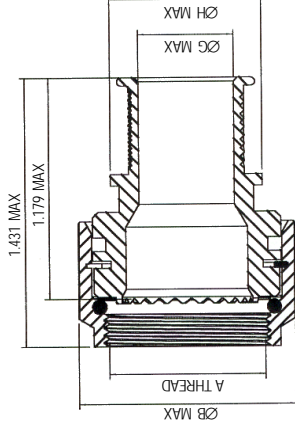

 THIRD ANGLE PROJECTION	MATERIAL AND FINISH CODES ARE SPECIFIED ON ORDER	CHECKED SCALE	DIMENSIONS IN MM TOLERANCES		AMPHENOL LTD Amphenol Ltd Thanet Way, Whitstable, Kent. CT5 3JF Tel: 01227 773200 Fax: 01227 276571	This drawing is the property of Amphenol Ltd and shall not be copied or disclosed to a third party without the express permission of Amphenol Ltd Amphenol Ltd 2000®	TITLE BACKSHELL STRAIGHT
	NOTE: ALL DIMENSIONS SHOWN ARE FINISHED DIMENSIONS AFTER PLATING/METAL FINISHING		Drawing Number 5001 SERIES				

Amphenol

PART NUMBER	A-THREAD	ØB MAX	ØG MAX	ØH MAX	REC HELLERMAN		SPRING REF
					BOOT 90°	BOOT STRAIGHT	
5001-08-00-00-10-AA-XX	7/16-28 UNEF	0.714	0.255	0.5528	1152-4-GW24	152-42-GW24	HE 050
5001-10-00-00-10-AA-XX	9/16-24 UNEF	0.805	0.317	0.6146	1154-4-GW24	154-42-GW24	HE 100
5001-12-00-00-10-AA-XX	11/16-24 UNEF	0.970	0.443	0.7406	1155-4-GW24	155-42-GW24	HE 100
5001-14-00-00-10-AA-XX	13/16-20 UNEF	1.147	0.505	0.8028	1155-4-GW24	155-42-GW24	HE 200
5001-16-00-00-10-AA-XX	15/16-20 UNEF	1.265	0.630	0.9280	1156-4-GW24	156-42-GW24	HE 200
5001-18-00-00-10-AA-XX	1 1/16-18 UNEF	1.285	0.755	1.0528	1156-4-GW24	156-42-GW24	HE 300
5001-20-00-00-10-AA-XX	1 3/16-18 UNEF	1.566	0.881	1.1780	1157-4-GW24	157-43-GW24	HE 300
5001-22-00-00-10-AA-XX	1 5/16-18 UNEF	1.704	1.006	1.3028	1157-4-GW24	157-43-GW24	HE 300
5001-24-00-00-10-AA-XX	1 7/16-18 UNEF	1.742	1.006	1.3028	1157-4-GW24	157-43-GW24	HE 300
5001-08-06-00-10-AA-XX	7/16 - 28 UNEF	0.714	0.190	0.5528	1152-4-GW24	152-42-GW24	HE 050
5001-10-08-00-10-AA-XX	9/16-24 UNEF	0.805	0.255	0.5528	1154-4-GW24	154-42-GW24	HE 050
5001-12-10-00-10-AA-XX	11/16-24 UNEF	0.970	0.317	0.6146	1155-4-GW24	155-42-GW24	HE 100
5001-14-12-00-10-AA-XX	13/16-20 UNEF	1.147	0.443	0.7406	1155-4-GW24	155-42-GW24	HE 100
5001-16-14-00-10-AA-XX	15/16-20 UNEF	1.265	0.505	0.8028	1156-4-GW24	156-42-GW24	HE 200
5001-18-16-00-10-AA-XX	1 1/16-18 UNEF	1.285	0.630	0.9280	1156-4-GW24	156-42-GW24	HE 200
5001-20-18-00-10-AA-XX	1 3/16-18 UNEF	1.566	0.755	1.0528	1157-4-GW24	157-43-GW24	HE 300
5001-22-20-00-10-AA-XX	1 5/16-18 UNEF	1.704	0.881	1.1780	1157-4-GW24	157-43-GW24	HE 300
5001-24-22-00-10-AA-XX	1 7/16-18 UNEF	1.742	1.006	1.3028	1157-4-GW24	157-43-GW24	HE 300

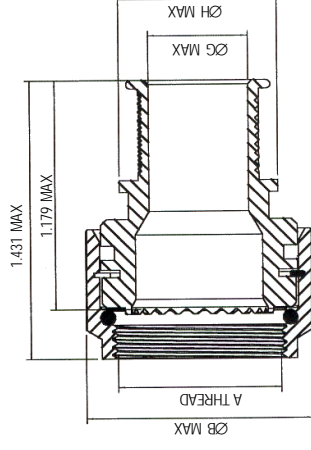

 THIRD ANGLE PROJECTION	MATERIAL AND FINISH CODES ARE SPECIFIED ON ORDER	CHECKED	DIMENSIONS IN INCHES		AMPHENOL LTD Amphenol Ltd Thanet Way, Whitstable, Kent. CT5 3JF Tel: 01227 773200 Fax: 01227 276571	This drawing is the property of Amphenol Ltd and shall not be copied or disclosed to a third party without the express permission of Amphenol Ltd Amphenol Ltd 2000®	TITLE
	NOTE: ALL DIMENSIONS SHOWN ARE FINISHED DIMENSIONS AFTER PLATING/METAL FINISHING	SCALE	TOLERANCES	Drawing Number			BACKSHELL STRAIGHT 5001 SERIES

Amphenol

PART NUMBER	A-THREAD	D MAX	ØB MAX	E MAX	ØG MAX	ØH MAX	J MAX	REC HELLERMAN BOOT STRAIGHT	SPRING REF
5001-08-00-90-10-AA-XX	7/16-28 UNEF	35.18	18.14	25.98	6.48	14.04	32.39	152-42-GW24	HE 050
5001-10-00-90-10-AA-XX	9/16-24 UNEF	38.35	20.45	29.16	8.05	15.61	35.56	154-42-GW24	HE 100
5001-12-00-90-10-AA-XX	11/16-24 UNEF	39.75	24.64	32.33	11.25	18.81	38.74	155-42-GW24	HE 100
5001-14-00-90-10-AA-XX	13/16-20 UNEF	46.30	29.13	37.11	12.83	20.39	43.51	155-42-GW24	HE 200
5001-16-00-90-10-AA-XX	15/16-20 UNEF	47.70	32.13	40.28	16.00	23.57	46.69	156-42-GW24	HE 200
5001-18-00-90-10-AA-XX	1 1/16-18 UNEF	47.70	32.64	40.28	19.18	26.74	46.69	156-42-GW24	HE 300
5001-20-00-90-10-AA-XX	1 3/16-18 UNEF	55.63	39.78	48.21	22.38	29.92	54.61	157-43-GW24	HE 300
5001-22-00-90-10-AA-XX	1 5/16-18 UNEF	58.80	43.28	51.38	25.55	33.09	57.79	157-43-GW24	HE 300
5001-24-00-90-10-AA-XX	1 7/16-18 UNEF	58.80	44.25	51.38	25.55	33.09	57.79	157-43-GW24	HE 300
5001-08-06-90-10-AA-XX	7/16 - 28 UNEF	33.40	18.14	25.98	4.83	14.04	32.39	152-42-GW24	HE 050
5001-10-08-90-10-AA-XX	9/16-24 UNEF	36.58	20.45	29.16	6.48	14.04	35.56	154-42-GW24	HE 050
5001-12-10-90-10-AA-XX	11/16-24 UNEF	39.75	24.64	32.33	8.05	15.61	38.74	155-42-GW24	HE 100
5001-14-12-90-10-AA-XX	13/16-20 UNEF	44.53	29.13	37.11	11.25	18.81	43.51	155-42-GW24	HE 100
5001-16-14-90-10-AA-XX	15/16-20 UNEF	47.70	32.13	40.28	12.83	20.39	46.69	156-42-GW24	HE 200
5001-18-16-90-10-AA-XX	1 1/16-18 UNEF	47.70	32.64	40.28	16.00	23.57	46.69	156-42-GW24	HE 200
5001-20-18-90-10-AA-XX	1 3/16-18 UNEF	55.63	39.78	48.21	19.18	26.74	54.61	157-43-GW24	HE 300
5001-22-20-90-10-AA-XX	1 5/16-18 UNEF	58.80	43.28	51.38	22.38	29.92	57.79	157-43-GW24	HE 300
5001-24-22-90-10-AA-XX	1 7/16-18 UNEF	58.80	44.25	51.38	25.55	33.09	57.79	157-43-GW24	HE 300

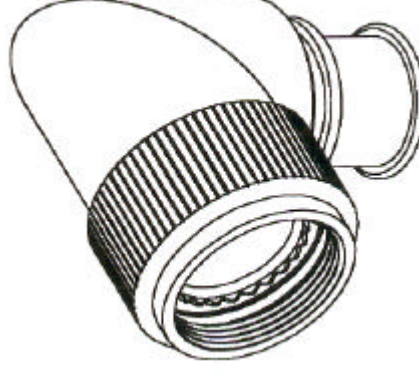
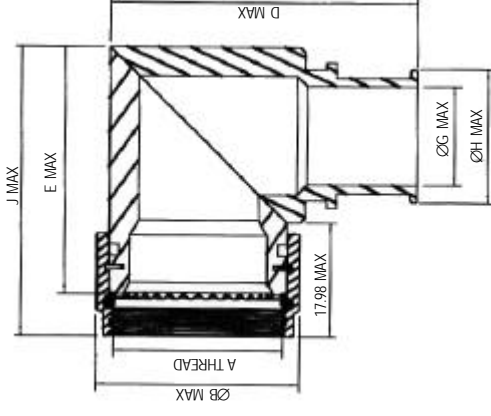

 THIRD ANGLE PROJECTION	MATERIAL AND FINISH CODES ARE SPECIFIED ON ORDER	CHECKED	DIMENSIONS IN		AMPHENOL LTD Amphenol Ltd Thanet Way, Whitstable, Kent. CT5 3JF Tel: 01227 773200 Fax: 01227 276571	This drawing is the property of Amphenol Ltd and shall not be copied or disclosed to a third party without the express permission of Amphenol Ltd Amphenol Ltd 2000®	BACKSHELL RIGHT ANGLE 5001 SERIES
	NOTE: ALL DIMENSIONS SHOWN ARE FINISHED DIMENSIONS AFTER PLATING/METAL FINISHING	SCALE	MM	TOLERANCES			

Amphenol

PART NUMBER	A-THREAD	D MAX	ØB MAX	E MAX	ØG MAX	ØH MAX	J MAX	REC HELLERMAN BOOT STRAIGHT	SPRING REF
5001-08-00-90-10-AA-XX	7/16-28 UNEF	1.385	0.714	1.023	0.255	0.5528	1.275	152-42-GW24	HE 050
5001-10-00-90-10-AA-XX	9/16-24 UNEF	1.510	0.805	1.148	0.317	0.6146	1.400	154-42-GW24	HE 100
5001-12-00-90-10-AA-XX	11/16-24 UNEF	1.565	0.970	1.273	0.443	0.7406	1.525	155-42-GW24	HE 100
5001-14-00-90-10-AA-XX	13/16-20 UNEF	1.823	1.147	1.461	0.505	0.8028	1.713	155-42-GW24	HE 200
5001-16-00-90-10-AA-XX	15/16-20 UNEF	1.878	1.265	1.586	0.630	0.9280	1.838	156-42-GW24	HE 200
5001-18-00-90-10-AA-XX	1 1/16-18 UNEF	1.878	1.285	1.586	0.755	1.0528	1.838	156-42-GW24	HE 300
5001-20-00-90-10-AA-XX	1 3/16-18 UNEF	2.190	1.566	1.898	0.881	1.1780	2.150	157-43-GW24	HE 300
5001-22-00-90-10-AA-XX	1 5/16-18 UNEF	2.315	1.704	2.023	1.006	1.3028	2.275	157-43-GW24	HE 300
5001-24-00-90-10-AA-XX	1 7/16-18 UNEF	2.315	1.742	2.023	1.006	1.3028	2.275	157-43-GW24	HE 300
5001-08-06-90-10-AA-XX	7/16 - 28 UNEF	1.315	0.714	1.023	0.190	0.5528	1.275	152-42-GW24	HE 050
5001-10-08-90-10-AA-XX	9/16-24 UNEF	1.440	0.805	1.148	0.255	0.5528	1.400	154-42-GW24	HE 050
5001-12-10-90-10-AA-XX	11/16-24 UNEF	1.565	0.970	1.273	0.317	0.6146	1.525	155-42-GW24	HE 100
5001-14-12-90-10-AA-XX	13/16-20 UNEF	1.753	1.147	1.461	0.443	0.7406	1.713	155-42-GW24	HE 100
5001-16-14-90-10-AA-XX	15/16-20 UNEF	1.878	1.265	1.586	0.505	0.8028	1.838	156-42-GW24	HE 200
5001-18-16-90-10-AA-XX	1 1/16-18 UNEF	1.878	1.285	1.586	0.630	0.9280	1.838	156-42-GW24	HE 200
5001-20-18-90-10-AA-XX	1 3/16-18 UNEF	2.190	1.566	1.898	0.755	1.0528	2.150	157-43-GW24	HE 300
5001-22-20-90-10-AA-XX	1 5/16-18 UNEF	2.315	1.704	2.023	0.881	1.1780	2.275	157-43-GW24	HE 300
5001-24-22-90-10-AA-XX	1 7/16-18 UNEF	2.315	1.742	2.023	1.006	1.3028	2.275	157-43-GW24	HE 300

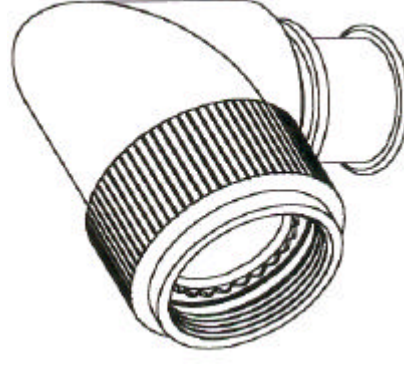
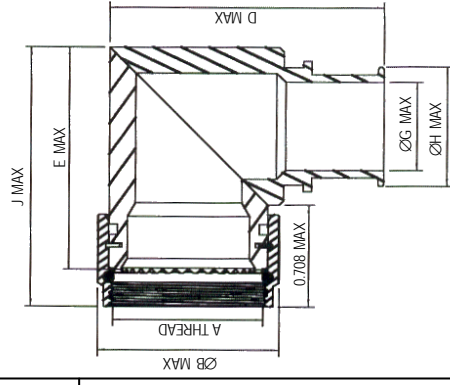

 THIRD ANGLE PROJECTION	MATERIAL AND FINISH CODES ARE SPECIFIED ON ORDER	CHECKED	DIMENSIONS IN		AMPHENOL LTD Amphenol Ltd Thanet Way, Whitstable, Kent. CT5 3JF Tel: 01227 773200 Fax: 01227 276571	This drawing is the property of Amphenol Ltd and shall not be copied or disclosed to a third party without the express permission of Amphenol Ltd Amphenol Ltd 2000®	TITLE
	NOTE: ALL DIMENSIONS SHOWN ARE FINISHED DIMENSIONS AFTER PLATING/METAL FINISHING	SCALE	INCHES	TOLERANCES			BACKSHELL RIGHT ANGLE 5001 SERIES

Amphenol

PART NUMBER	A-THREAD	ØB MAX	ØG MAX	ØH MAX	REC HELLERMAN BOOT 90°	REC HELLERMAN BOOT STRAIGHT
5101-08-00-00-10-AA-XX	7/16-28 UNEF	18.14	6.48	14.04	1152-4-GW24	152-42-GW24
5101-10-00-00-10-AA-XX	9/16-24 UNEF	20.45	8.05	15.61	1154-4-GW24	154-42-GW24
5101-12-00-00-10-AA-XX	11/16-24 UNEF	24.64	11.25	18.81	1155-4-GW24	155-42-GW24
5101-14-00-00-10-AA-XX	13/16-20 UNEF	29.13	12.83	20.39	1155-4-GW24	155-42-GW24
5101-16-00-00-10-AA-XX	15/16-20 UNEF	32.13	16.00	23.57	1156-4-GW24	156-42-GW24
5101-18-00-00-10-AA-XX	1 1/16-18 UNEF	32.64	19.18	26.74	1156-4-GW24	156-42-GW24
5101-20-00-00-10-AA-XX	1 3/16-18 UNEF	39.78	22.38	29.92	1157-4-GW24	157-43-GW24
5101-22-00-00-10-AA-XX	1 5/16-18 UNEF	43.28	25.55	33.09	1157-4-GW24	157-43-GW24
5101-24-00-00-10-AA-XX	1 7/16-18 UNEF	44.25	25.55	33.09	1157-4-GW24	157-43-GW24

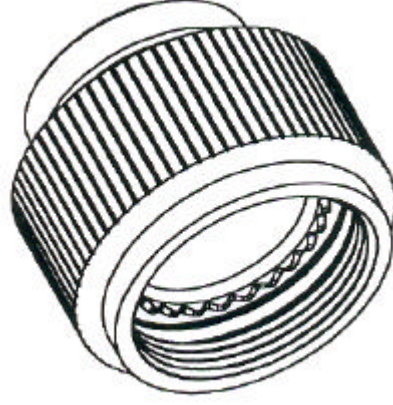
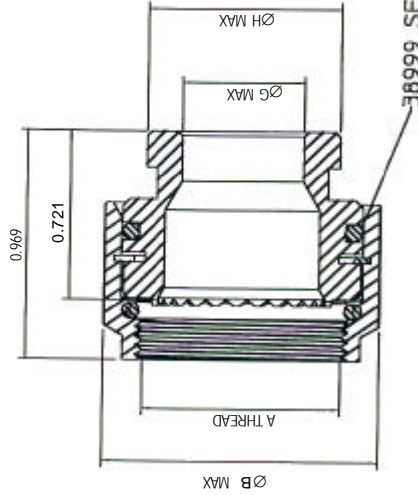

THIRD ANGLE PROJECTION

MATERIAL AND FINISH CODES ARE SPECIFIED ON ORDER
NOTE: ALL DIMENSIONS SHOWN ARE FINISHED DIMENSIONS AFTER PLATING/METAL FINISHING

CHECKED
SCALE

DIMENSIONS IN
MM
TOLERANCES

AMPHENOL LTD
Amphenol Ltd
Thanet Way,
Whitstable, Kent.
CT5 3JF
Tel: 01227 773200 Fax: 01227 276571

This drawing is the property of Amphenol Ltd and shall not be copied or disclosed to a third party without the express permission of Amphenol Ltd Amphenol Ltd 2000[©]

TITLE
BACKSHELL STRAIGHT FOR HEATSHRINK BOOT
Drawing Number
5101 SERIES

Amphenol

PART NUMBER	A-THREAD	ØB MAX	ØG MAX	ØH MAX	REC HELLERMAN BOOT 90°	REC HELLERMAN BOOT STRAIGHT
5101-08-00-00-10-AA-XX	7/16-28 UNEF	0.714	0.255	0.5528	1152-4-GW24	152-42-GW24
5101-10-00-00-10-AA-XX	9/16-24 UNEF	0.805	0.317	0.6146	1154-4-GW24	154-42-GW24
5101-12-00-00-10-AA-XX	11/16-24 UNEF	0.970	0.443	0.7406	1155-4-GW24	155-42-GW24
5101-14-00-00-10-AA-XX	13/16-20 UNEF	1.147	0.505	0.8028	1155-4-GW24	155-42-GW24
5101-16-00-00-10-AA-XX	15/16-20 UNEF	1.265	0.630	0.9280	1156-4-GW24	156-42-GW24
5101-18-00-00-10-AA-XX	1 1/16-18 UNEF	1.285	0.755	1.0528	1156-4-GW24	156-42-GW24
5101-20-00-00-10-AA-XX	1 3/16-18 UNEF	1.566	0.881	1.1780	1157-4-GW24	157-43-GW24
5101-22-00-00-10-AA-XX	1 5/16-18 UNEF	1.704	1.006	1.3028	1157-4-GW24	157-43-GW24
5101-24-00-00-10-AA-XX	1 7/16-18 UNEF	1.742	1.006	1.3028	1157-4-GW24	157-43-GW24

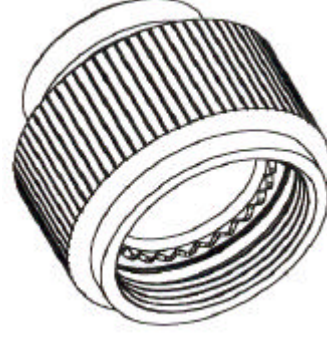

 THIRD ANGLE PROJECTION	MATERIAL AND FINISH CODES ARE SPECIFIED ON ORDER	CHECKED	DIMENSIONS IN Inches	AMPHENOL LTD Amphenol Ltd Thanet Way, Whitstable, Kent. CT5 3JF Tel: 01227 773200 Fax: 01227 276571		This drawing is the property of Amphenol Ltd and shall not be copied or disclosed to a third party without the express permission of Amphenol Ltd Amphenol Ltd 2000®	TITLE BACKSHELL STRAIGHT WITH HEATSHRINK BOOT Drawing Number 5101 SERIES
	NOTE: ALL DIMENSIONS SHOWN ARE FINISHED DIMENSIONS AFTER PLATING/METAL FINISHING	SCALE	TOLERANCES				

Part Number Information

AIA50 01 XX XX XX XX XX XX

Denotes Backshell Style

50 = Zeta Lock Termination with heatshrink boot groove
 51 = Spin Coupler to take heatshrink boot

Denotes Connector Style

01 = Series 2 62GB

Denotes Connector Shell Size

8, 10, 12, 14, 16, 18, 20, 22, 24

Denotes Backshell Inlet Size

See Chart for Inlet Standard
 Consult Factory for Alternatives

Denotes Backshell Exit Angle

00 = 0°
 45 = 45°
 90 = 90°
 Consult Factory for Alternatives

Denotes Working Length

00 = Standard
 Consult Factory for Alternatives

Denotes Backshell Material

AA = Aluminium Alloy
 RB = Aluminium Bronze
 SS = Stainless Steel

Denotes Backshell Plating Finish

01 = Unplated
 02 = Electroless Nickel
 03 = Cadmium with Olive Drab Chromate Passivation
 04 = Zinc Cobalt with Green Chromate Passivation
 05 = Zinc Cobalt with Black Chromate Passivation

For further information on cables, connectors and assemblies please consult your local office.
 Product specifications and performance characteristics are typical only, and subject to change.

Notice: Products are sold subject to Amphenol's conditions of sale ("the standard conditions"). All specifications and statements contained herein are believed to be correct at the time of printing, but no representation or warranty, express or implied, is given as to any specification or statement contained herein. Product specifications including performance characteristics are typical only and subject to deviation. Specifications are also subject to change without notice. Users should not assume that all safety measures are indicated or that other measures may not be required. No representation or warranty, express or implied, is given that any use of products (including any stated or suggested use) does not infringe any patent, registered design or other third party rights and no stated or suggested use of products can be taken to recommend any such infringement.