

Surface Mount 915.00MHz SAW Filter

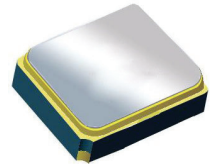

1.4 x 1.1 x 0.7 mm

AFS14A26-915.00-T3



**RoHS
Compliant**

Moisture Sensitivity Level (MSL) – This product is Hermetically Sealed and not Moisture Sensitive - MSL = N/A: Not Applicable

FEATURES:

- 1.4 x 1.1 x 0.7 mm low profile SMT package
- Low Insertion loss
- Excellent selectivity with high out-of-band rejection

APPLICATIONS:

- Wireless Communication
- Remote Control
- Cellular Phones

ELECTRICAL SPECIFICATIONS:

Maximum Ratings

Item	Value
Input Power Level	+10 dBm max.
DC Permissive Voltage	3.0V DC max.
Operating Temperature Range	-30°C to + 85°C
Storage Temperature Range	-40°C to + 85°C

Parameters	Minimum	Typical	Maximum	Units	Notes
Center Frequency (f_c)		915.00		MHz	
Insertion Loss (IL)		2.5	3.1	dB	902 ~ 928MHz
Effective Bandwidth		26		MHz	
Amplitude Ripple		0.4	1.5	dB	902 ~ 928MHz
Group Delay Variation		15	50	ns	902 ~ 928MHz
Worst-Case Input / Output Return Loss	9.0	10.0		dB	902 ~ 928MHz
Stop-band Attenuation (Referenced to 0.0 dB)	50	53		dB	0.1~702 MHz
	49	53			738~764 MHz
	42	48			820~846 MHz
	42	50			990~1010 MHz
	49	53			1072~1092 MHz
	40	42			1128~1804 MHz
	40	42			1804~1856 MHz
	30	36			1856~3000 MHz
Source Impedance (Z_S)		50		Ω	See note # 1
Load Impedance (Z_L)		50		Ω	See note # 1

Note #1: No matching network required for operation into 50 Ω 's

TEST CIRCUIT:

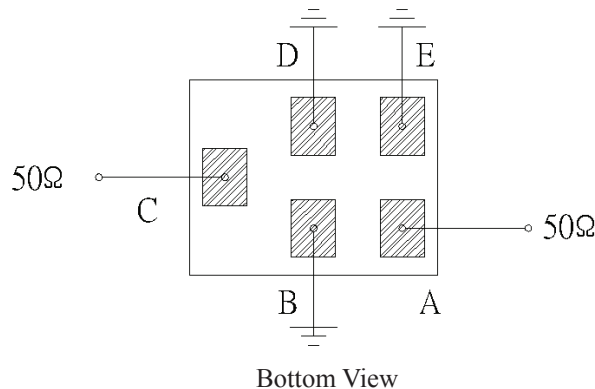

Surface Mount 915.00MHz SAW Filter

AFS14A26-915.00-T3



RoHS
Compliant

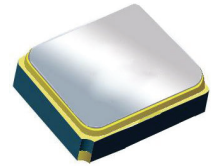

1.4 x 1.1 x 0.7 mm

OUTLINE DIMENSIONS:

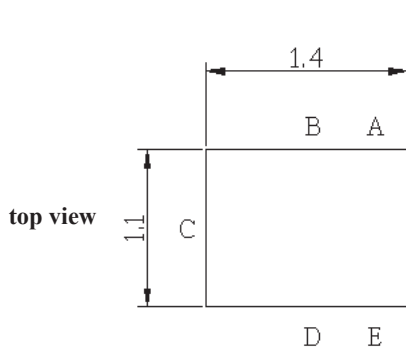

side view

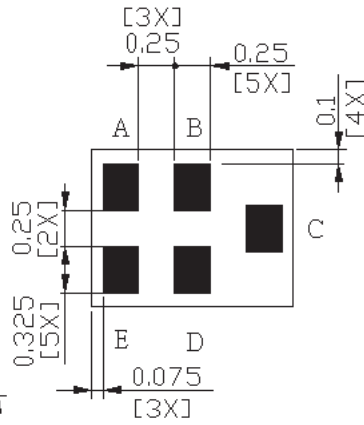

C:	Input
A:	Output
B, D, E:	Ground

Recommended Land Pattern:

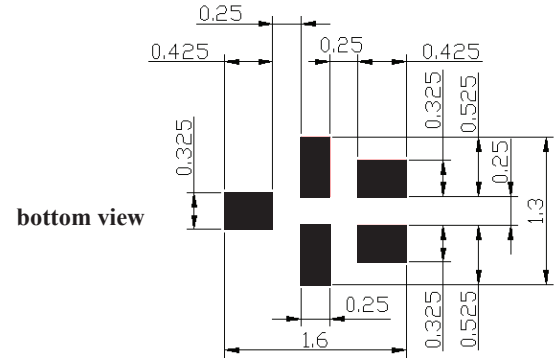

■ : Land Pattern
Unit : mm

*All Dimensions are in mm



Surface Mount 915.00MHz SAW Filter

AFS14A26-915.00-T3



RoHS
Compliant



1.4 x 1.1 x 0.7 mm

FREQUENCY CHARACTERISTICS:

Filter Frequency Response (Narrowband)

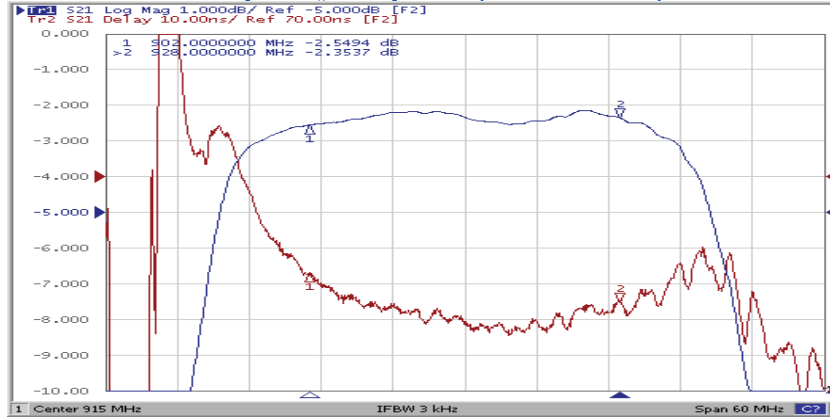

Filter Frequency Response (Wideband)

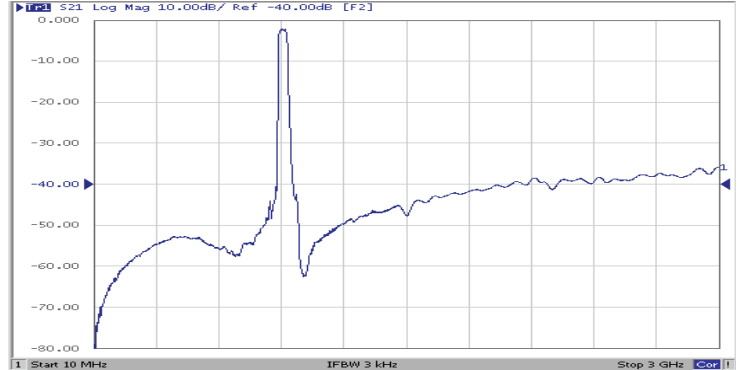
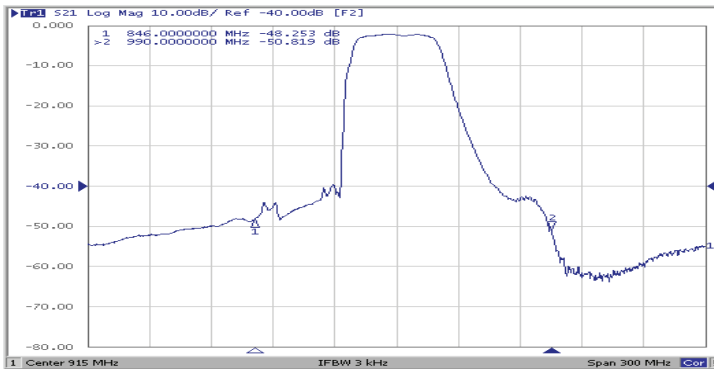

REFLECTION FUNCTIONS:

S11

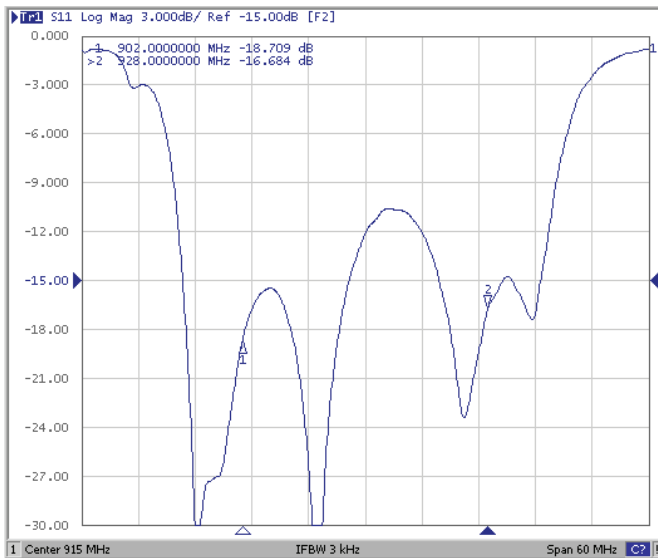

S22

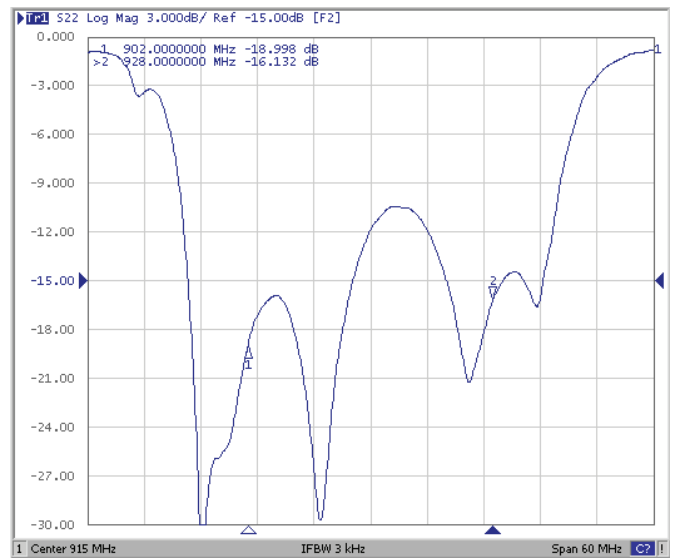

Surface Mount 915.00MHz SAW Filter

AFS14A26-915.00-T3



RoHS
Compliant

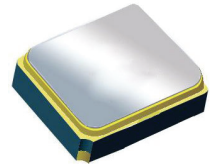

1.4 x 1.1 x 0.7 mm

REFLOW PROFILE:

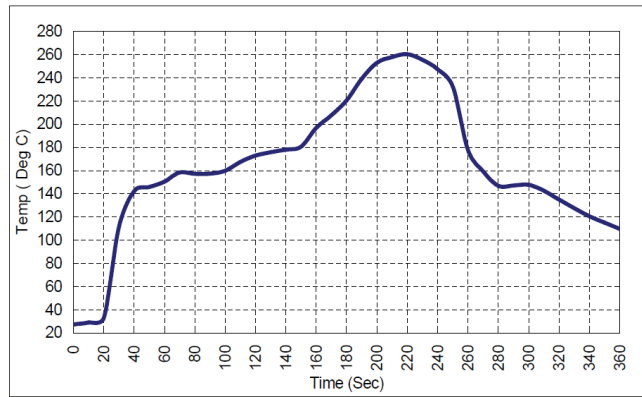

PACKAGING: 3000 Units/Reel “-T2” parts (2k/reel) are no longer available effective 01/01/2013

Reel Count : 7" = 3k units

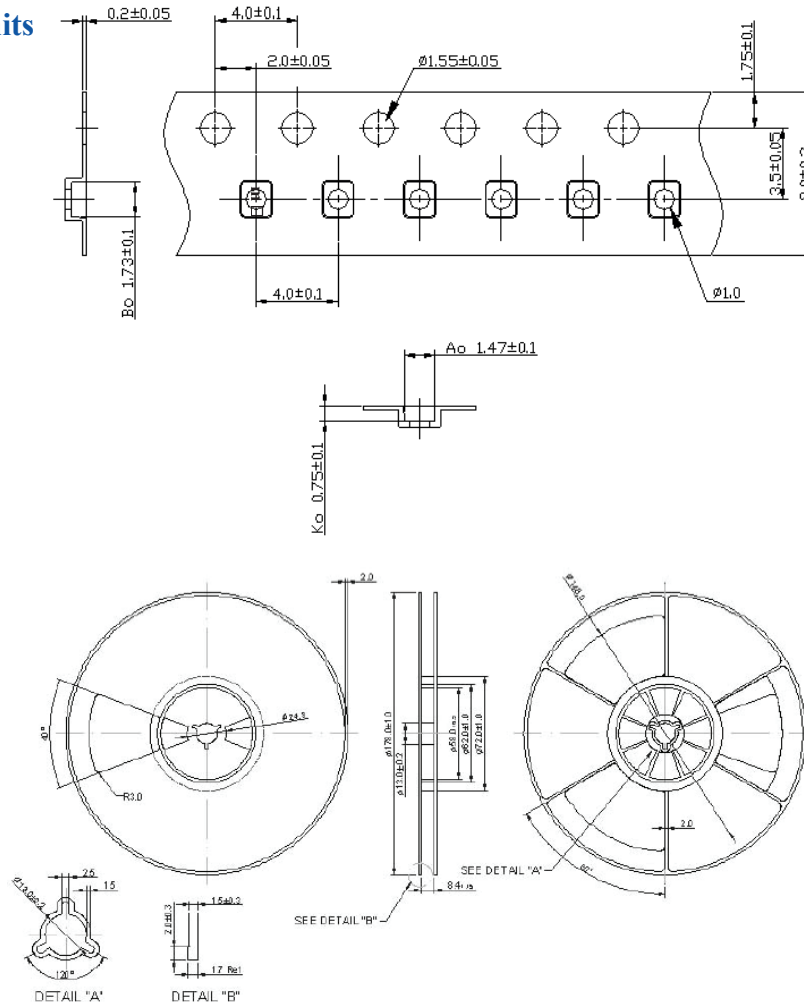

ATTENTION: Abracon Corporation's products are COTS – Commercial-Off-The-Shelf products; suitable for Commercial, Industrial and, where designated, Automotive Applications. Abracon's products are not specifically designed for Military, Aviation, Aerospace, Life-dependant Medical applications or any application requiring high reliability where component failure could result in loss of life and/or property. For applications requiring high reliability and/or presenting an extreme operating environment, written consent and authorization from Abracon Corporation is required. Please contact Abracon Corporation for more information.

ABRACON IS
ISO 9001:2008
CERTIFIED



Visit www.abracon.com for Terms & Conditions of Sale
30332 Esperanza, Rancho Santa Margarita, California 92688
tel 949-546-8000 | fax 949-546-8001 | www.abracon.com

Revised: 04.16.13

Mouser Electronics

Authorized Distributor

Click to View Pricing, Inventory, Delivery & Lifecycle Information:

[ABRACON:](#)

[AFS14A26-915.00-T3](#)