

### FEATURES

- Easy to use, single-ended-to-differential conversion
- Adjustable output common-mode voltage
- Externally adjustable gain
- Low harmonic distortion
  - 94 dBc SFDR @ 5 MHz
  - 85 dBc SFDR @ 20 MHz
- 3 dB bandwidth of 300 MHz,  $G = +1$
- Fast settling to 0.01% of 16 ns
- Slew rate: 1150 V/ $\mu$ s
- Fast overdrive recovery of 4 ns
- Low input voltage noise of 5 nV/ $\sqrt{\text{Hz}}$
- 1 mV typical offset voltage
- Wide supply range: +3 V to  $\pm 5$  V
- Low power: 90 mW on 5 V
- 0.1 dB gain flatness to 30 MHz
- Available in 8-lead SOIC and MSOP packages

### APPLICATIONS

- ADC drivers
- Single-ended-to-differential converters
- IF and baseband gain blocks
- Differential buffers
- Line drivers

### GENERAL DESCRIPTION

The AD8138A is a major advancement over op amps for differential signal processing. The AD8138A can be used as a single-ended-to-differential amplifier or as a differential-to-differential amplifier. The AD8138A is as easy to use as an op amp and greatly simplifies differential signal amplification and driving.

Manufactured on the Analog Devices, Inc., proprietary XFCB bipolar process, the AD8138A has a –3 dB bandwidth of 300 MHz and delivers a differential signal with low harmonic distortion. The AD8138A has a unique internal feedback feature that provides balanced output gain and phase matching, suppressing even-order harmonics. The internal feedback circuit minimizes any gain error that is associated with the mismatches in the external gain setting resistors.

The differential output of the AD8138A helps balance the input to differential analog-to-digital converters (ADCs), maximizing the performance of the ADC.

### PIN CONFIGURATION

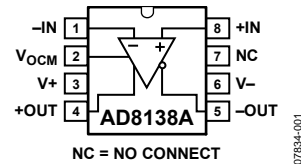

Figure 1.

### TYPICAL APPLICATION CIRCUIT

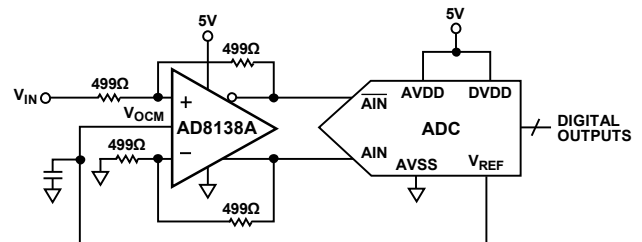

Figure 2.

The AD8138A eliminates the need for a transformer with high performance ADCs, preserving the low frequency and dc information. The common-mode level of the differential output is adjustable by a voltage on the  $V_{OCM}$  pin, easily level shifting the input signals for driving single-supply ADCs. Fast overload recovery preserves sampling accuracy.

The AD8138A distortion performance makes it an ideal ADC driver for communication systems, with distortion performance good enough to drive state-of-the-art 10-bit to 16-bit converters at high frequencies. The high bandwidth and IP3 of the AD8138A make it appropriate for use as a gain block in IF and baseband signal chains. The AD8138A offset and dynamic performance makes it well-suited for a wide variety of signal processing and data acquisition applications.

The AD8138A is available in both SOIC and MSOP packages for operation over the  $-40^{\circ}\text{C}$  to  $+85^{\circ}\text{C}$  temperature range.

#### Rev. 0

Information furnished by Analog Devices is believed to be accurate and reliable. However, no responsibility is assumed by Analog Devices for its use, nor for any infringements of patents or other rights of third parties that may result from its use. Specifications subject to change without notice. No license is granted by implication or otherwise under any patent or patent rights of Analog Devices. Trademarks and registered trademarks are the property of their respective owners.

**TABLE OF CONTENTS**

|  |    |  |    |
|--|----|--|----|
| Features .....                                   | 1  | Theory of Operation .....  | 17 |
| Applications.....                                | 1  | Analyzing an Application Circuit .....                                 | 17 |
| Pin Configuration.....                           | 1  | Setting the Closed-Loop Gain .....                                     | 17 |
| Typical Application Circuit .....                | 1  | Estimating the Output Noise Voltage .....                              | 17 |
| General Description .....                        | 1  | The Impact of Mismatches in the Feedback Networks .....                | 18 |
| Revision History .....                           | 2  | Calculating The Input Impedance of an Application<br>Circuit .....     | 18 |
| Specifications.....                              | 3  | Input Common-Mode Voltage Range in Single-Supply<br>Applications ..... | 18 |
| $\pm$ IN to $\pm$ OUT Specifications.....        | 3  | Setting the Output Common-Mode Voltage.....                            | 18 |
| $V_{OCM}$ to $\pm$ OUT Specifications .....      | 4  | Driving a Capacitive Load.....   | 18 |
| $\pm$ IN to $\pm$ OUT Specifications.....        | 5  | Layout, Grounding, and Bypassing.....                                  | 19 |
| $V_{OCM}$ to $\pm$ OUT Specifications .....      | 6  | Balanced Transformer Driver .....                                      | 20 |
| Absolute Maximum Ratings.....                    | 7  | High Performance ADC Driving .....                                     | 21 |
| Thermal Resistance .....                         | 7  | 3 V Operation .....  | 22 |
| ESD Caution.....                                 | 7  | Outline Dimensions .....   | 23 |
| Pin Configuration and Function Descriptions..... | 8  | Ordering Guide .....   | 23 |
| Typical Performance Characteristics .....        | 9  |  |    |
| Test Circuits.....                               | 15 |  |    |
| Terminology .....                                | 16 |  |    |

**REVISION HISTORY****10/08—Revision 0: Initial Version**

## SPECIFICATIONS

### ±IN to ±OUT SPECIFICATIONS

At 25°C,  $V_S = \pm 5\text{ V}$ ,  $V_{OCM} = 0\text{ V}$ ,  $G = +1$ ,  $R_{L, dm} = 500\ \Omega$ , unless otherwise noted. Refer to Figure 39 for test setup and label descriptions. All specifications refer to single-ended input and differential outputs, unless otherwise noted.

Table 1.

| Parameter                                     | Test Conditions/Comments  | Min | Typ          | Max | Unit                         |
|---|---|-----|--------------|-----|------------------------------|
| <b>DYNAMIC PERFORMANCE</b>                    |   |     |              |     |                              |
| –3 dB Small Signal Bandwidth                  | $V_{OUT} = 0.5\text{ V p-p}$ , $C_F = 0\text{ pF}$                            | 260 | 300          |     | MHz                          |
|   | $V_{OUT} = 0.5\text{ V p-p}$ , $C_F = 1\text{ pF}$                            |     | 225          |     | MHz                          |
| Bandwidth for 0.1 dB Flatness                 | $V_{OUT} = 0.5\text{ V p-p}$ , $C_F = 0\text{ pF}$                            |     | 30           |     | MHz                          |
| Large Signal Bandwidth                        | $V_{OUT} = 2\text{ V p-p}$ , $C_F = 0\text{ pF}$                              |     | 265          |     | MHz                          |
| Slew Rate                                     | $V_{OUT} = 2\text{ V p-p}$ , $C_F = 0\text{ pF}$                              |     | 1150         |     | V/ $\mu\text{s}$             |
| Settling Time                                 | 0.01%, $V_{OUT} = 2\text{ V p-p}$ , $C_F = 1\text{ pF}$                       |     | 16           |     | ns                           |
| Overdrive Recovery Time                       | $V_{IN} = 5\text{ V to }0\text{ V step}$ , $G = +2$                           |     | 4            |     | ns                           |
| <b>NOISE/HARMONIC PERFORMANCE<sup>1</sup></b> |   |     |              |     |                              |
| Second Harmonic                               | $V_{OUT} = 2\text{ V p-p}$ , 5 MHz, $R_{L, dm} = 800\ \Omega$                 |     | –94          |     | dBc                          |
|   | $V_{OUT} = 2\text{ V p-p}$ , 20 MHz, $R_{L, dm} = 800\ \Omega$                |     | –87          |     | dBc                          |
|   | $V_{OUT} = 2\text{ V p-p}$ , 70 MHz, $R_{L, dm} = 800\ \Omega$                |     | –62          |     | dBc                          |
| Third Harmonic                                | $V_{OUT} = 2\text{ V p-p}$ , 5 MHz, $R_{L, dm} = 800\ \Omega$                 |     | –114         |     | dBc                          |
|   | $V_{OUT} = 2\text{ V p-p}$ , 20 MHz, $R_{L, dm} = 800\ \Omega$                |     | –85          |     | dBc                          |
|   | $V_{OUT} = 2\text{ V p-p}$ , 70 MHz, $R_{L, dm} = 800\ \Omega$                |     | –57          |     | dBc                          |
| IMD   | 20 MHz  |     | –77          |     | dBc                          |
| IP3   | 20 MHz  |     | 37           |     | dBm                          |
| Voltage Noise (RTI)                           | $f = 100\text{ kHz to }40\text{ MHz}$   |     | 5            |     | nV/ $\sqrt{\text{Hz}}$       |
| Input Current Noise                           | $f = 100\text{ kHz to }40\text{ MHz}$   |     | 2            |     | pA/ $\sqrt{\text{Hz}}$       |
| <b>INPUT CHARACTERISTICS</b>                  |   |     |              |     |                              |
| Offset Voltage                                | $V_{OS, dm} = V_{OUT, dm}/2$ ; $V_{+DIN} = V_{-DIN} = V_{OCM} = 0\text{ V}$   | –3  | +1           | +3  | mV                           |
|   | $T_{MIN}$ to $T_{MAX}$ variation  |     | $\pm 4$      |     | $\mu\text{V}/^\circ\text{C}$ |
| Input Bias Current                            |   |     | 3.5          | 7   | $\mu\text{A}$                |
|   | $T_{MIN}$ to $T_{MAX}$ variation  |     | –0.01        |     | $\mu\text{A}/^\circ\text{C}$ |
| Input Resistance                              | Differential  |     | 6            |     | M $\Omega$                   |
|   | Common mode   |     | 3            |     | M $\Omega$                   |
| Input Capacitance                             |   |     | 1            |     | pF                           |
| Input Common-Mode Voltage                     |   |     | –4.7 to +3.4 |     | V                            |
| CMRR  | $\Delta V_{OUT, dm}/\Delta V_{IN, cm}$ ; $\Delta V_{IN, cm} = \pm 1\text{ V}$ |     | –77          | –70 | dB                           |
| <b>OUTPUT CHARACTERISTICS</b>                 |   |     |              |     |                              |
| Output Voltage Swing                          | Maximum $\Delta V_{OUT}$ ; single-ended output                                |     | 7.75         |     | V p-p                        |
| Output Current                                |   |     | 95           |     | mA                           |
| Output Balance Error                          | $\Delta V_{OUT, cm}/\Delta V_{OUT, dm}$ ; $\Delta V_{OUT, dm} = 1\text{ V}$   |     | –66          |     | dB                           |

<sup>1</sup> Harmonic distortion performance is equal or slightly worse with higher values of  $R_{L, dm}$ . See Figure 17 and Figure 18 for more information.

# AD8138A

## V<sub>OCM</sub> to ±OUT SPECIFICATIONS

At 25°C, V<sub>S</sub> = ±5 V, V<sub>OCM</sub> = 0 V, G = +1, R<sub>L, dm</sub> = 500 Ω, unless otherwise noted. Refer to Figure 39 for test setup and label descriptions. All specifications refer to single-ended input and differential outputs, unless otherwise noted.

Table 2.

| Parameter                    | Test Conditions/Comments  | Min    | Typ  | Max    | Unit   |
|------------------------------|---|--------|------|--------|--------|
| <b>DYNAMIC PERFORMANCE</b>   |   |        |      |        |        |
| –3 dB Bandwidth              |   |        | 250  |        | MHz    |
| Slew Rate                    |   |        | 330  |        | V/μs   |
| INPUT VOLTAGE NOISE (RTI)    | f = 0.1 MHz to 100 MHz  |        | 17   |        | nV/√Hz |
| <b>DC PERFORMANCE</b>        |   |        |      |        |        |
| Input Voltage Range          |   |        | ±3.8 |        | V      |
| Input Resistance             |   |        | 200  |        | kΩ     |
| Input Offset Voltage         | V <sub>OS, cm</sub> = V <sub>OUT, cm</sub> ; V <sub>+DIN</sub> = V <sub>–DIN</sub> = V <sub>OCM</sub> = 0 V | –10    | ±3   | +10    | mV     |
| Input Bias Current           |   |        | 0.5  |        | μA     |
| V <sub>OCM</sub> CMRR        | ΔV <sub>OUT, dm</sub> /ΔV <sub>OCM</sub> ; ΔV <sub>OCM</sub> = ±1 V   |        | –75  |        | dB     |
| Gain                         | ΔV <sub>OUT, cm</sub> /ΔV <sub>OCM</sub> ; ΔV <sub>OCM</sub> = ±1 V   | 0.9955 | 1    | 1.0045 | V/V    |
| <b>POWER SUPPLY</b>          |   |        |      |        |        |
| Operating Range              |   | ±1.4   |      | ±5.5   | V      |
| Quiescent Current            |   | 16     | 20   | 24     | mA     |
|                              | T <sub>MIN</sub> to T <sub>MAX</sub> variation  |        | 40   |        | μA/°C  |
| Power Supply Rejection Ratio | ΔV <sub>OUT, dm</sub> /ΔV <sub>S</sub> ; ΔV <sub>S</sub> = ±1 V   |        | –86  | –66    | dB     |
| OPERATING TEMPERATURE RANGE  |   | –40    |      | +85    | °C     |

**±IN to ±OUT SPECIFICATIONS**

At 25°C,  $V_S = 5\text{ V}$ ,  $V_{OCM} = 2.5\text{ V}$ ,  $G = +1$ ,  $R_{L, dm} = 500\ \Omega$ , unless otherwise noted. Refer to Figure 39 for test setup and label descriptions. All specifications refer to single-ended input and differential output, unless otherwise noted.

**Table 3.**

| Parameter                                     | Test Conditions/Comments  | Min | Typ          | Max | Unit                         |
|---|---|-----|--------------|-----|------------------------------|
| <b>DYNAMIC PERFORMANCE</b>                    |   |     |              |     |                              |
| –3 dB Small Signal Bandwidth                  | $V_{OUT} = 0.5\text{ V p-p}$ , $C_F = 0\text{ pF}$                          | 250 | 300          |     | MHz                          |
|   | $V_{OUT} = 0.5\text{ V p-p}$ , $C_F = 1\text{ pF}$                          |     | 225          |     | MHz                          |
| Bandwidth for 0.1 dB Flatness                 | $V_{OUT} = 0.5\text{ V p-p}$ , $C_F = 0\text{ pF}$                          |     | 29           |     | MHz                          |
| Large Signal Bandwidth                        | $V_{OUT} = 2\text{ V p-p}$ , $C_F = 0\text{ pF}$                            |     | 265          |     | MHz                          |
| Slew Rate                                     | $V_{OUT} = 2\text{ V p-p}$ , $C_F = 0\text{ pF}$                            |     | 950          |     | V/ $\mu\text{s}$             |
| Settling Time                                 | 0.01%, $V_{OUT} = 2\text{ V p-p}$ , $C_F = 1\text{ pF}$                     |     | 16           |     | ns                           |
| Overdrive Recovery Time                       | $V_{IN} = 2.5\text{ V to }0\text{ V step}$ , $G = +2$                       |     | 4            |     | ns                           |
| <b>NOISE/HARMONIC PERFORMANCE<sup>1</sup></b> |   |     |              |     |                              |
| Second Harmonic                               | $V_{OUT} = 2\text{ V p-p}$ , 5 MHz, $R_{L, dm} = 800\ \Omega$               |     | –90          |     | dBc                          |
|   | $V_{OUT} = 2\text{ V p-p}$ , 20 MHz, $R_{L, dm} = 800\ \Omega$              |     | –79          |     | dBc                          |
|   | $V_{OUT} = 2\text{ V p-p}$ , 70 MHz, $R_{L, dm} = 800\ \Omega$              |     | –60          |     | dBc                          |
| Third Harmonic                                | $V_{OUT} = 2\text{ V p-p}$ , 5 MHz, $R_{L, dm} = 800\ \Omega$               |     | –100         |     | dBc                          |
|   | $V_{OUT} = 2\text{ V p-p}$ , 20 MHz, $R_{L, dm} = 800\ \Omega$              |     | –82          |     | dBc                          |
|   | $V_{OUT} = 2\text{ V p-p}$ , 70 MHz, $R_{L, dm} = 800\ \Omega$              |     | –53          |     | dBc                          |
| IMD   | 20 MHz  |     | –74          |     | dBc                          |
| IP3   | 20 MHz  |     | 35           |     | dBm                          |
| Voltage Noise (RTI)                           | $f = 100\text{ kHz to }40\text{ MHz}$                                       |     | 5            |     | nV/ $\sqrt{\text{Hz}}$       |
| Input Current Noise                           | $f = 100\text{ kHz to }40\text{ MHz}$                                       |     | 2            |     | pA/ $\sqrt{\text{Hz}}$       |
| <b>INPUT CHARACTERISTICS</b>                  |   |     |              |     |                              |
| Offset Voltage                                | $V_{OS, dm} = V_{OUT, dm}/2$ ; $V_{+DIN} = V_{-DIN} = V_{OCM} = 0\text{ V}$ | –3  | +1           | +3  | mV                           |
|   | $T_{MIN}$ to $T_{MAX}$ variation  |     | ±4           |     | $\mu\text{V}/^\circ\text{C}$ |
| Input Bias Current                            |   |     | 3.5          | 7   | $\mu\text{A}$                |
|   | $T_{MIN}$ to $T_{MAX}$ variation  |     | –0.01        |     | $\mu\text{A}/^\circ\text{C}$ |
| Input Resistance                              | Differential  |     | 6            |     | M $\Omega$                   |
|   | Common mode   |     | 3            |     | M $\Omega$                   |
| Input Capacitance                             |   |     | 1            |     | pF                           |
| Input Common-Mode Voltage                     |   |     | –0.3 to +3.2 |     | V                            |
| CMRR  | $\Delta V_{OUT, dm}/\Delta V_{IN, cm}$ ; $\Delta V_{IN, cm} = 1\text{ V}$   |     | –77          | –70 | dB                           |
| <b>OUTPUT CHARACTERISTICS</b>                 |   |     |              |     |                              |
| Output Voltage Swing                          | Maximum $\Delta V_{OUT}$ , single-ended output                              |     | 2.9          |     | V p-p                        |
| Output Current                                |   |     | 95           |     | mA                           |
| Output Balance Error                          | $\Delta V_{OUT, cm}/\Delta V_{OUT, dm}$ ; $\Delta V_{OUT, dm} = 1\text{ V}$ |     | –65          |     | dB                           |

<sup>1</sup> Harmonic distortion performance is equal or slightly worse with higher values of  $R_{L, dm}$ . See Figure 17 and Figure 18 for more information.

# AD8138A

## V<sub>OCM</sub> TO ±OUT SPECIFICATIONS

At 25°C, V<sub>S</sub> = 5 V, V<sub>OCM</sub> = 2.5 V, G = +1, R<sub>L, dm</sub> = 500 Ω, unless otherwise noted. Refer to Figure 39 for test setup and label descriptions. All specifications refer to single-ended input and differential output, unless otherwise noted.

Table 4.

| Parameter                    | Test Conditions/Comments  | Min    | Typ        | Max    | Unit   |
|------------------------------|---|--------|------------|--------|--------|
| <b>DYNAMIC PERFORMANCE</b>   |   |        |            |        |        |
| –3 dB Bandwidth              |   |        | 220        |        | MHz    |
| Slew Rate                    |   |        | 250        |        | V/μs   |
| INPUT VOLTAGE NOISE (RTI)    | f = 0.1 MHz to 100 MHz  |        | 17         |        | nV/√Hz |
| <b>DC PERFORMANCE</b>        |   |        |            |        |        |
| Input Voltage Range          |   |        | 1.0 to 3.8 |        | V      |
| Input Resistance             |   |        | 100        |        | kΩ     |
| Input Offset Voltage         | V <sub>OS, cm</sub> = V <sub>OUT, cm</sub> ; V <sub>+DIN</sub> = V <sub>-DIN</sub> = V <sub>OCM</sub> = 0 V | –12    | ±4         | +12    | mV     |
| Input Bias Current           |   |        | 0.5        |        | μA     |
| V <sub>OCM</sub> CMRR        | ΔV <sub>OUT, dm</sub> /ΔV <sub>OCM</sub> ; ΔV <sub>OCM</sub> = 2.5 V ± 1 V                                  |        | –70        |        | dB     |
| Gain                         | ΔV <sub>OUT, cm</sub> /ΔV <sub>OCM</sub> ; ΔV <sub>OCM</sub> = 2.5 V ± 1 V                                  | 0.9968 | 1          | 1.0032 | V/V    |
| <b>POWER SUPPLY</b>          |   |        |            |        |        |
| Operating Range              |   | 2.7    |            | 11     | V      |
| Quiescent Current            |   | 14     | 18         | 22     | mA     |
|                              | T <sub>MIN</sub> to T <sub>MAX</sub> variation  |        | 40         |        | μA/°C  |
| Power Supply Rejection Ratio | ΔV <sub>OUT, dm</sub> /ΔV <sub>S</sub> ; ΔV <sub>S</sub> = ± 1 V  |        | –82        | –66    | dB     |
| OPERATING TEMPERATURE RANGE  |   | –40    |            | +85    | °C     |

## ABSOLUTE MAXIMUM RATINGS

Table 5.

| Parameter                           | Rating  |
|-------------------------------------|---|
| Supply Voltage                      | $\pm 5.5$ V                                     |
| $V_{OCM}$                           | $\pm V_S$                                       |
| Internal Power Dissipation          | 550 mW  |
| Operating Temperature Range         | $-40^{\circ}\text{C}$ to $+85^{\circ}\text{C}$  |
| Storage Temperature Range           | $-65^{\circ}\text{C}$ to $+150^{\circ}\text{C}$ |
| Lead Temperature (Soldering 10 sec) | $300^{\circ}\text{C}$                           |
| Junction Temperature                | $150^{\circ}\text{C}$                           |

Stresses above those listed under Absolute Maximum Ratings may cause permanent damage to the device. This is a stress rating only; functional operation of the device at these or any other conditions above those indicated in the operational section of this specification is not implied. Exposure to absolute maximum rating conditions for extended periods may affect device reliability.

### THERMAL RESISTANCE

$\theta_{JA}$  is specified for the worst-case conditions, that is,  $\theta_{JA}$  is specified for the device soldered in a circuit board in still air.

Table 6.

| Package Type        | $\theta_{JA}$ | Unit                        |
|---------------------|---------------|-----------------------------|
| 8-Lead SOIC/4-Layer | 121           | $^{\circ}\text{C}/\text{W}$ |
| 8-Lead MSOP/4-Layer | 145           | $^{\circ}\text{C}/\text{W}$ |

### Maximum Power Dissipation

The maximum safe power dissipation in the AD8138A packages is limited by the associated rise in junction temperature ( $T_J$ ) on the die. At approximately  $150^{\circ}\text{C}$ , which is the glass transition temperature, the plastic changes its properties. Even temporarily exceeding this temperature limit can change the stresses that the package exerts on the die, permanently shifting the parametric performance of the AD8138A. Exceeding a junction temperature of  $150^{\circ}\text{C}$  for an extended period can result in changes in the silicon devices, potentially causing failure.

The power dissipated in the package ( $P_D$ ) is the sum of the quiescent power dissipation and the power dissipated in the package due to the load drive for all outputs. The quiescent power is the voltage between the supply pins ( $V_S$ ) times the

quiescent current ( $I_S$ ). The load current consists of the differential and common-mode currents flowing to the load, as well as currents flowing through the external feedback networks and internal common-mode feedback loop. The internal resistor tap used in the common-mode feedback loop places a negligible differential load on the output. Consider the rms voltages and currents when dealing with ac signals.

Airflow reduces  $\theta_{JA}$ . In addition, more metal directly in contact with the package leads from metal traces, through holes, ground, and power planes, reduces the  $\theta_{JA}$ .

Figure 3 shows the maximum safe power dissipation in the package vs. the ambient temperature for the 8-lead SOIC ( $121^{\circ}\text{C}/\text{W}$ ) and 8-lead MSOP ( $\theta_{JA} = 145^{\circ}\text{C}/\text{W}$ ) packages on a JEDEC standard 4-layer board.  $\theta_{JA}$  values are approximations.

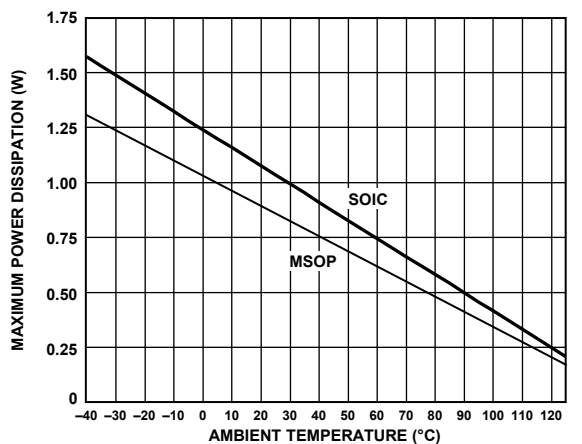

Figure 3. Maximum Power Dissipation vs. Ambient Temperature

### ESD CAUTION



**ESD (electrostatic discharge) sensitive device.** Charged devices and circuit boards can discharge without detection. Although this product features patented or proprietary protection circuitry, damage may occur on devices subjected to high energy ESD. Therefore, proper ESD precautions should be taken to avoid performance degradation or loss of functionality.

# AD8138A

## PIN CONFIGURATION AND FUNCTION DESCRIPTIONS

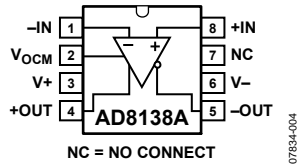

Figure 4. Pin Configuration

Table 7. Pin Function Descriptions

| Pin No. | Mnemonic         | Description  |
|---------|------------------|--|
| 1       | -IN              | Negative Input Summing Node.   |
| 2       | V <sub>OCM</sub> | Voltage applied to this pin sets the common-mode output voltage with a ratio of 1:1. For example, 1 V dc on V <sub>OCM</sub> sets the dc bias level on +OUT and -OUT to 1 V. |
| 3       | V+               | Positive Supply Voltage.   |
| 4       | +OUT             | Positive Output. Note that the voltage at -IN is inverted at +OUT (see Figure 42).   |
| 5       | -OUT             | Negative Output. Note that the voltage at +IN is inverted at -OUT (see Figure 42).   |
| 6       | V-               | Negative Supply Voltage.   |
| 7       | NC               | No Connect.  |
| 8       | +IN              | Positive Input Summing Node.   |



# TYPICAL PERFORMANCE CHARACTERISTICS

Unless otherwise noted, gain = +1,  $R_G = R_F = R_{L, dm} = 499 \Omega$ ,  $T_A = 25^\circ\text{C}$ ; refer to Figure 39 for test setup.

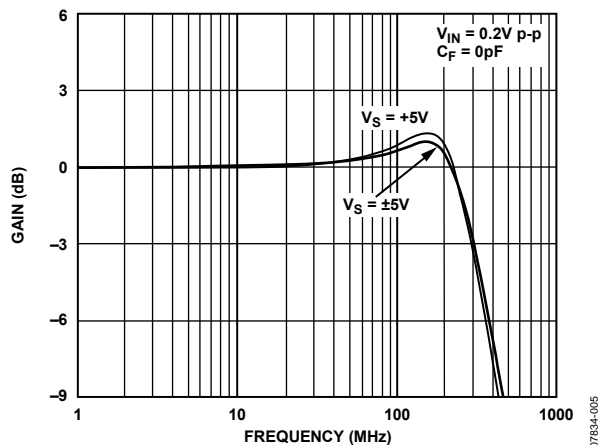

Figure 5. Small Signal Frequency Response

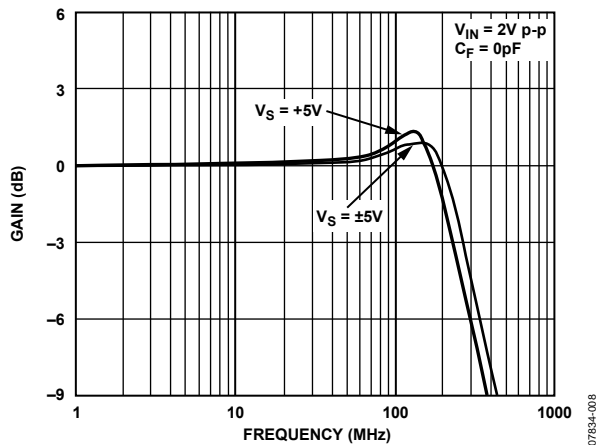

Figure 8. Large Signal Frequency Response

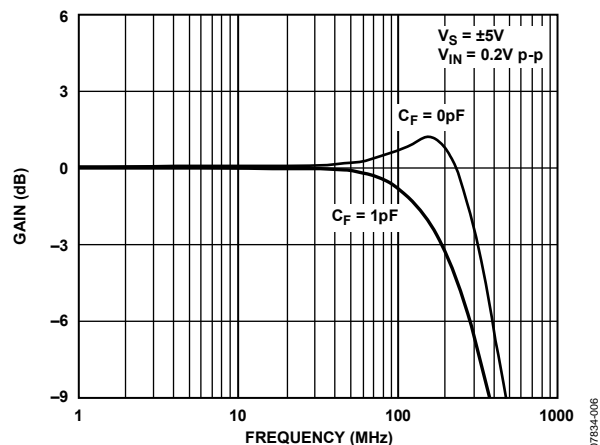

Figure 6. Small Signal Frequency Response

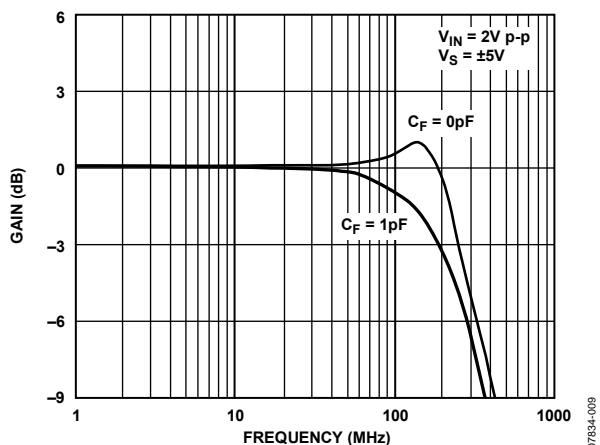

Figure 9. Large Signal Frequency Response

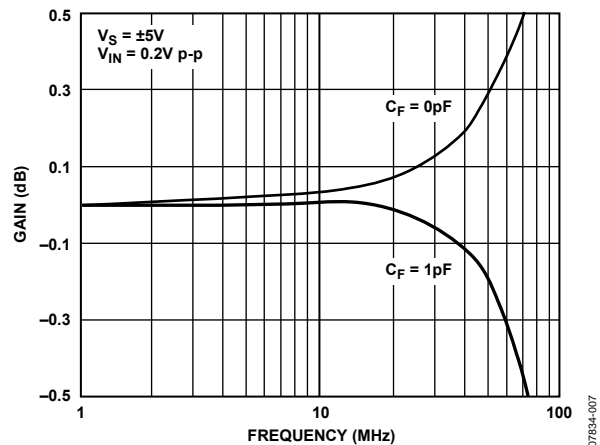

Figure 7. 0.1 dB Flatness vs. Frequency

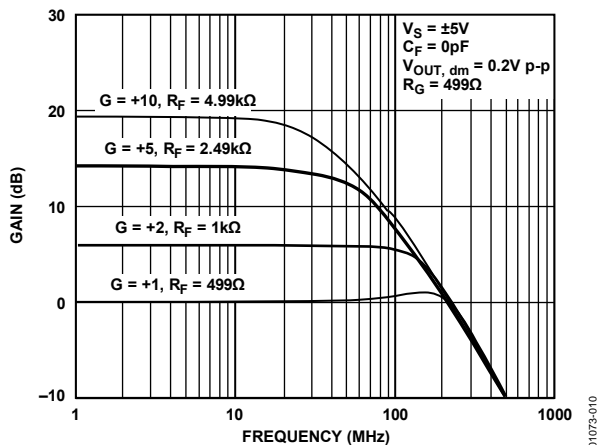

Figure 10. Small Signal Frequency Response for Various Gains

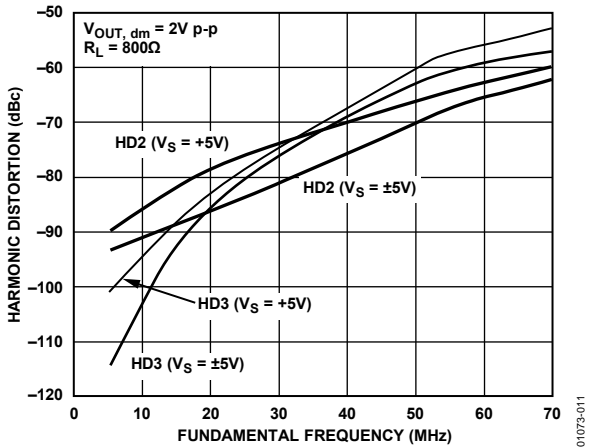

Figure 11. Harmonic Distortion vs. Fundamental Frequency

01073-011

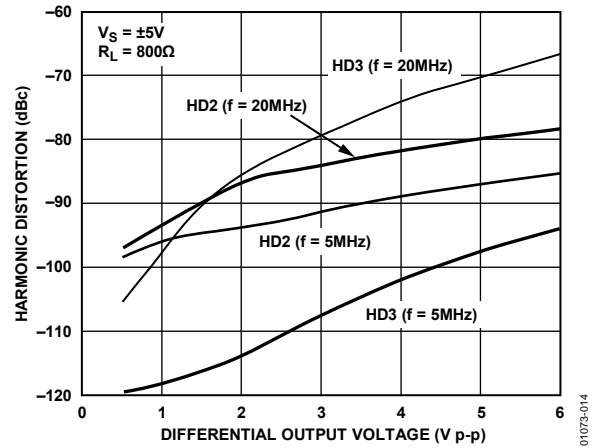

Figure 14. Harmonic Distortion vs. Differential Output Voltage

01073-014

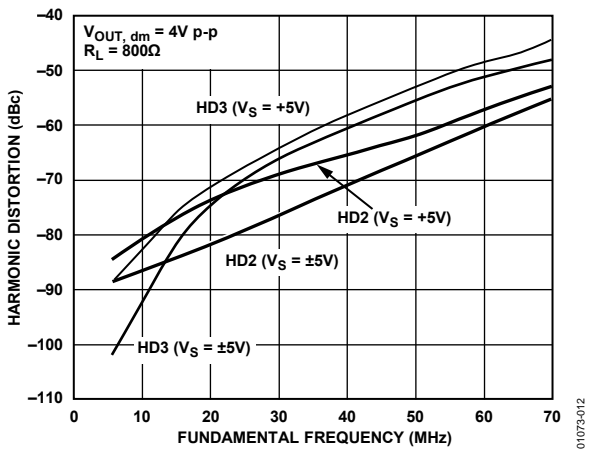

Figure 12. Harmonic Distortion vs. Fundamental Frequency

01073-012

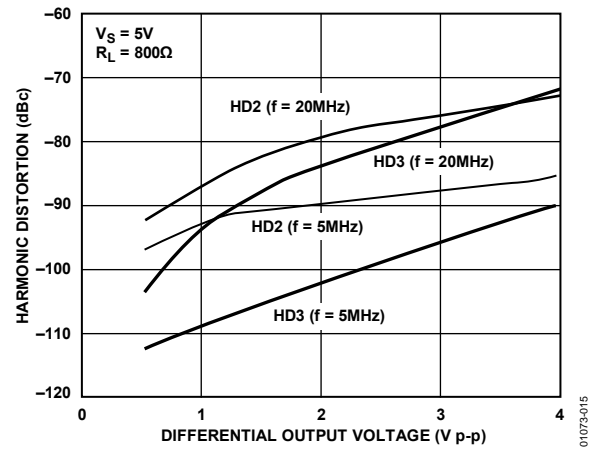

Figure 15. Harmonic Distortion vs. Differential Output Voltage

01073-015

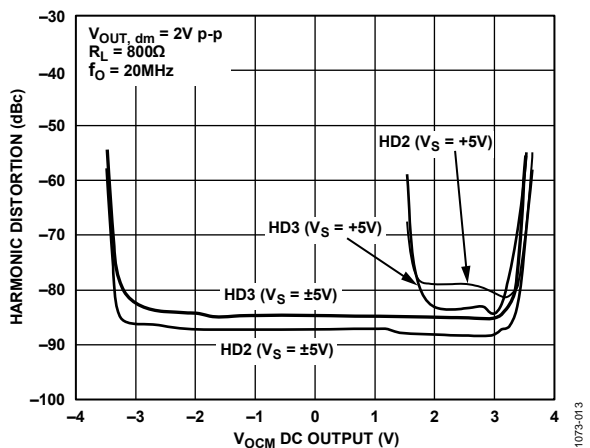

Figure 13. Harmonic Distortion vs.  $V_{OCM}$  DC Output

01073-013

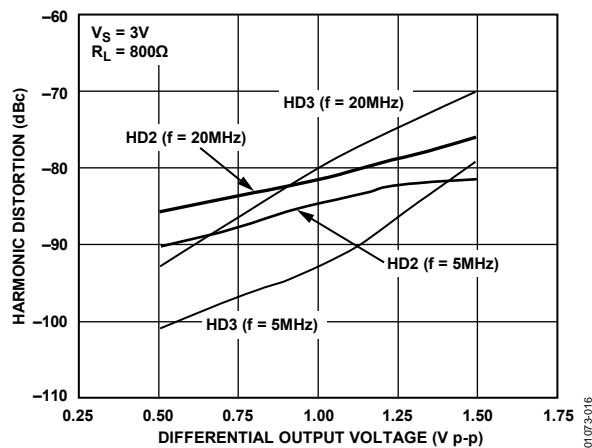

Figure 16. Harmonic Distortion vs. Differential Output Voltage

01073-016

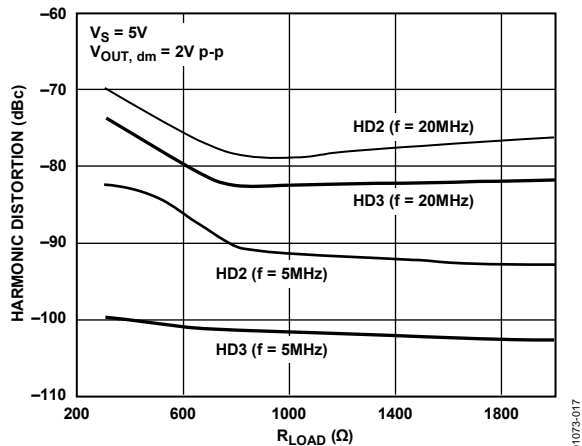

Figure 17. Harmonic Distortion vs.  $R_{LOAD}$

01073-017

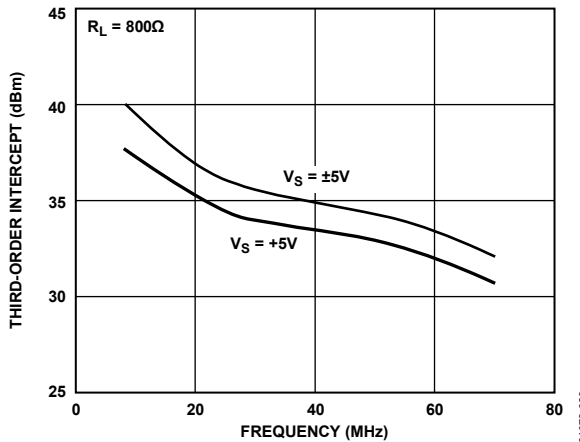

Figure 20. Third-Order Intercept vs. Frequency

01073-020

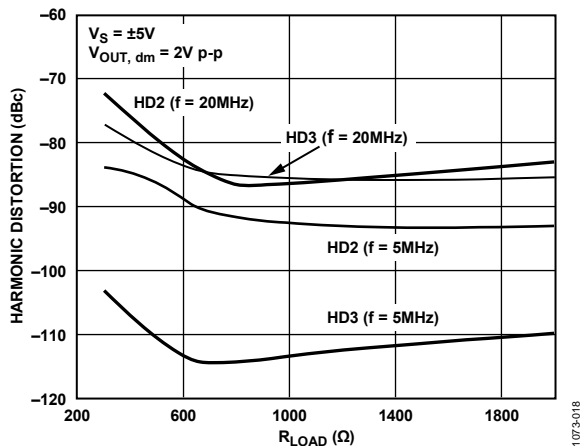

Figure 18. Harmonic Distortion vs.  $R_{LOAD}$

01073-018

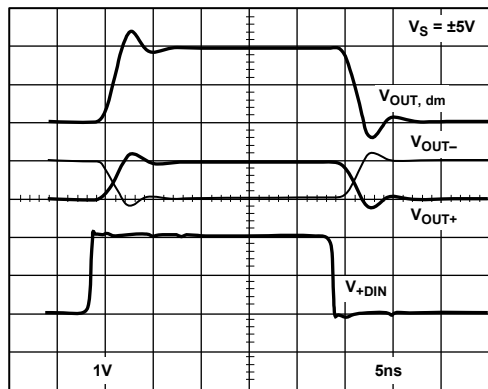

Figure 21. Large Signal Transient Response

07834-021

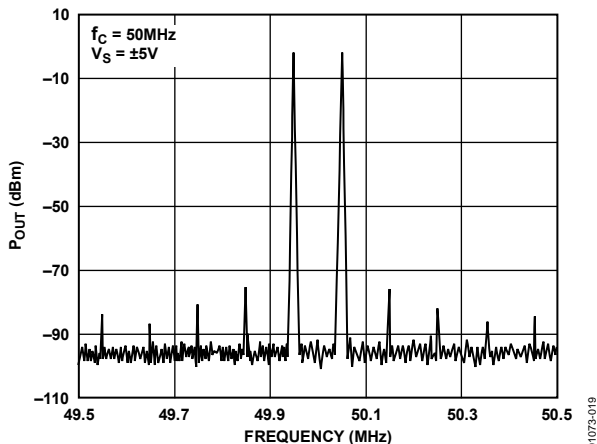

Figure 19. Intermodulation Distortion

01073-019

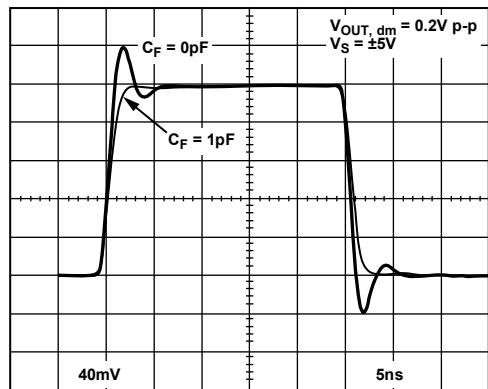

Figure 22. Small Signal Transient Response

07834-022

# AD8138A

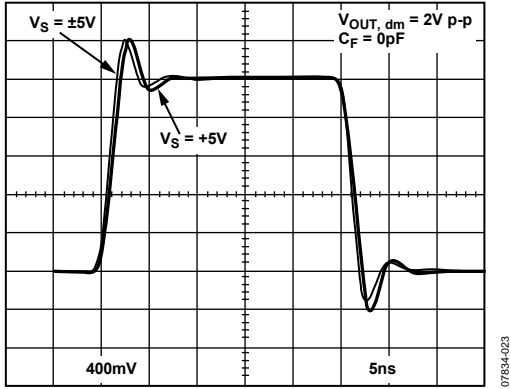

Figure 23. Large Signal Transient Response

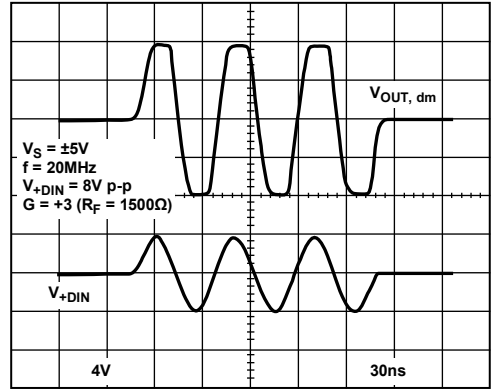

Figure 26. Output Overdrive

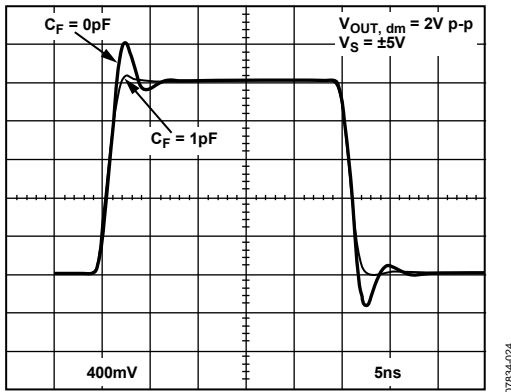

Figure 24. Large Signal Transient Response

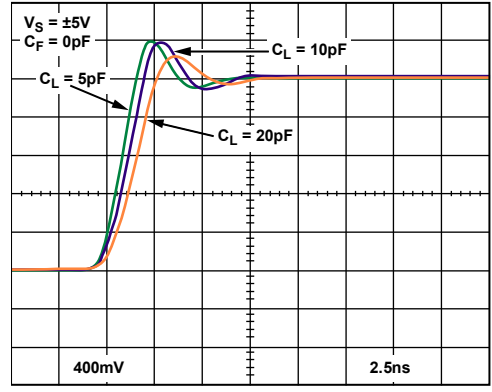

Figure 27. Large Signal Transient Response for Various Capacitor Loads (See Figure 40)

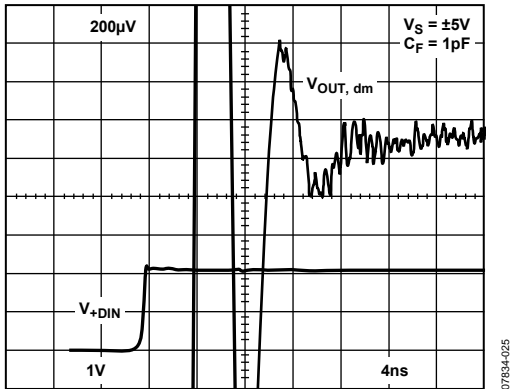

Figure 25. Settling Time

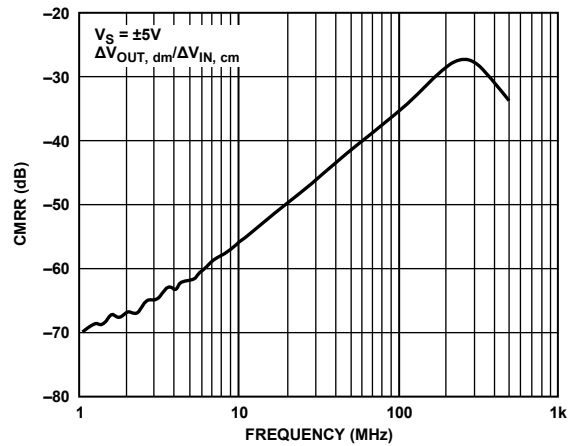

Figure 28. CMRR vs. Frequency

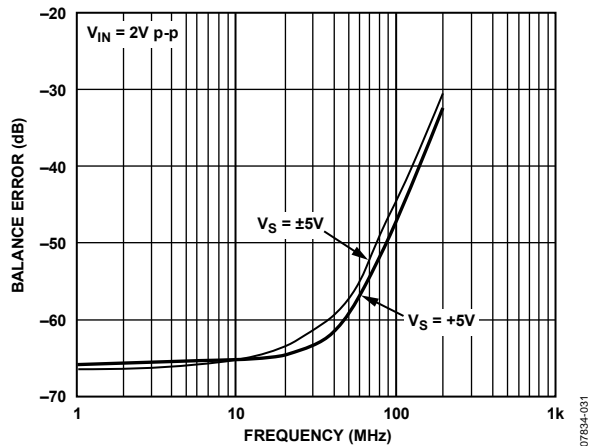

Figure 29. Output Balance Error vs. Frequency (See Figure 41)

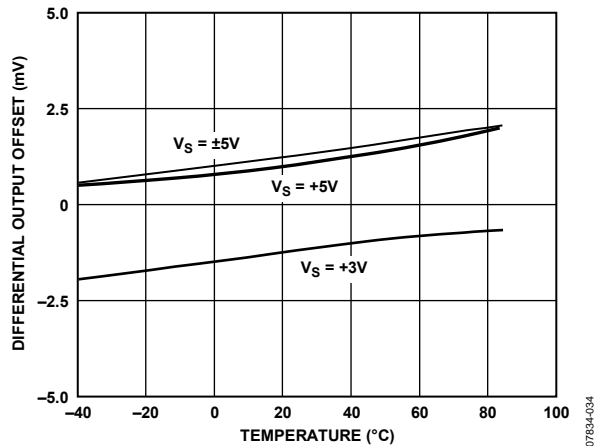

Figure 32. Output Referred Differential Offset Voltage vs. Temperature

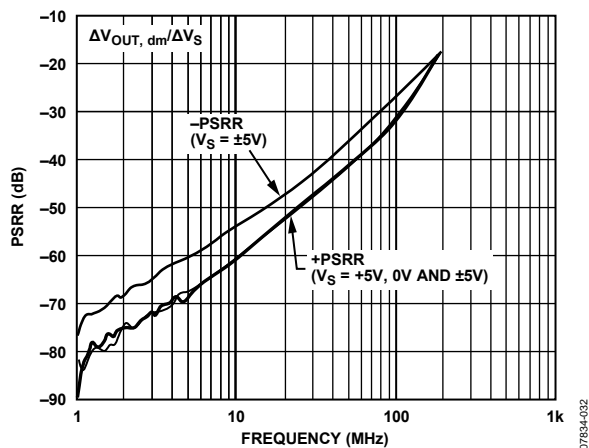

Figure 30. PSRR vs. Frequency

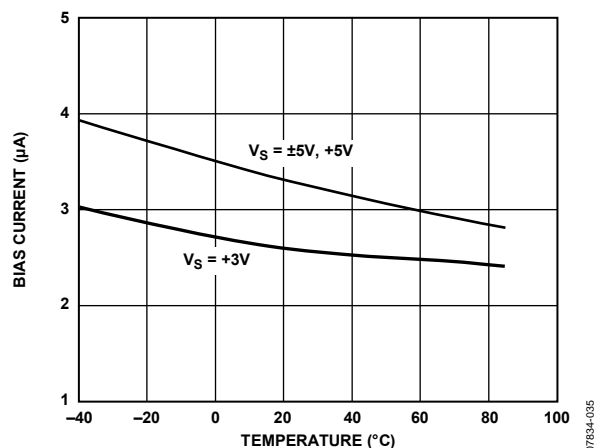

Figure 33. Input Bias Current vs. Temperature

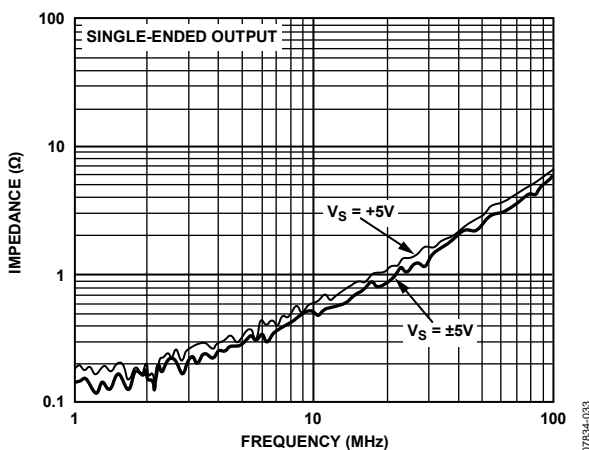

Figure 31. Output Impedance vs. Frequency

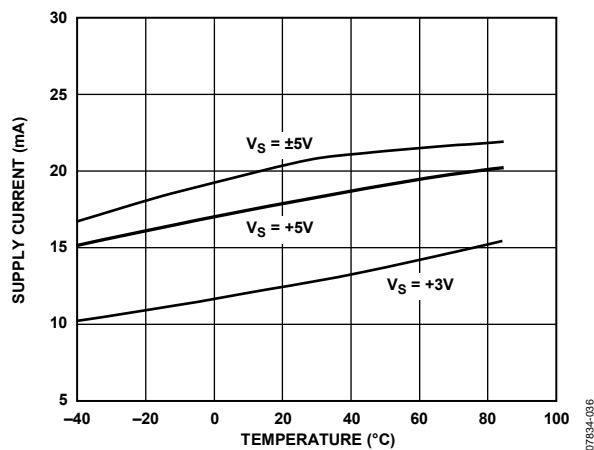

Figure 34. Supply Current vs. Temperature

# AD8138A

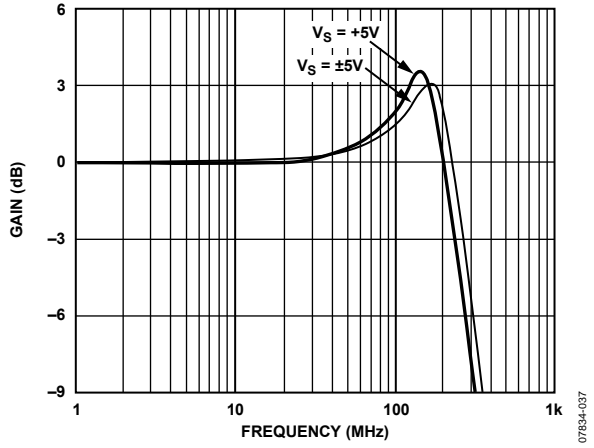

Figure 35.  $V_{OCM}$  Frequency Response

07834-037

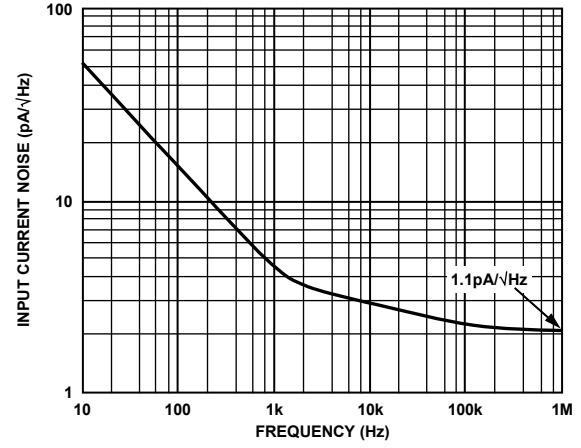

Figure 37. Current Noise (RTI)

07834-039

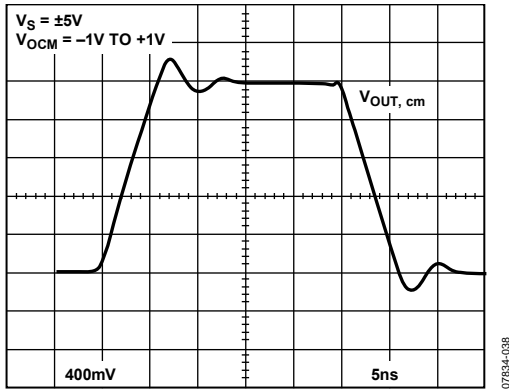

Figure 36.  $V_{OCM}$  Transient Response

07834-038

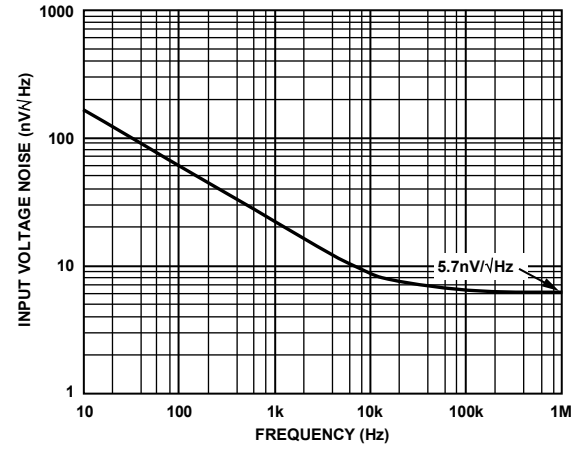

Figure 38. Voltage Noise (RTI)

07834-040

## TEST CIRCUITS

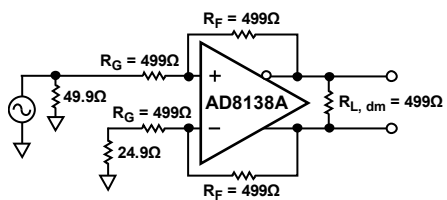

Figure 39. Basic Test Circuit

07834-003

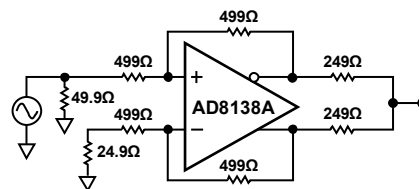

Figure 41. Test Circuit for Output Balance

07834-030

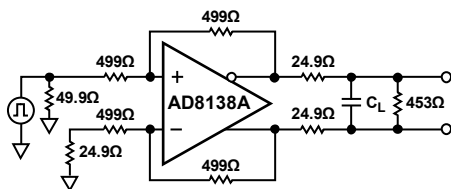

Figure 40. Test Circuit for Capacitor Load Drive

07834-027

## TERMINOLOGY

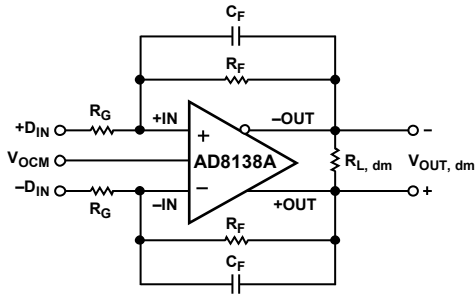

Figure 42. Circuit Definitions

07834-041

### Differential Voltage

Differential voltage refers to the difference between two node voltages. For example, the output differential voltage (or equivalently, output differential-mode voltage) is defined as

$$V_{OUT, dm} = (V_{+OUT} - V_{-OUT})$$

where  $V_{+OUT}$  and  $V_{-OUT}$  refer to the voltages at the +OUT and -OUT terminals with respect to a common reference.

### Common-Mode Voltage

Common-mode voltage refers to the average of two node voltages. The output common-mode voltage is defined as

$$V_{OUT, cm} = (V_{+OUT} + V_{-OUT})/2$$

### Output Balance

Balance is a measure of how well differential signals are matched in amplitude and exactly 180° apart in phase. Balance is most easily determined by placing a well-matched resistor divider between the differential voltage nodes and comparing the magnitude of the signal at the midpoint of the divider with the magnitude of the differential signal (see Figure 41). By this definition, output balance is the magnitude of the output common-mode voltage divided by the magnitude of the output differential-mode voltage.

$$\text{Output Balance Error} = \left| \frac{V_{OUT, cm}}{V_{OUT, dm}} \right|$$



## THEORY OF OPERATION

The AD8138A differs from conventional op amps in that it has two outputs whose voltages move in opposite directions. Similar to an op amp, it relies on high open-loop gain and negative feedback to force these outputs to the desired voltages. The AD8138A behaves much like a standard voltage feedback op amp and makes it easy to perform single-ended-to-differential conversion, common-mode level shifting, and amplification of differential signals. Also like an op amp, the AD8138A has high input impedance and low output impedance.

Previous differential drivers, both discrete and integrated designs, used two independent amplifiers and two independent feedback loops, one to control each of the outputs. When these circuits were driven from a single-ended source, the resulting outputs were typically not well balanced. Achieving a balanced output has often required exceptional matching of the amplifiers and feedback networks.

DC common-mode level shifting has also been difficult with previous differential drivers. Level shifting required the use of a third amplifier and feedback loop to control the output common-mode level. Sometimes the third amplifier was used in an attempt to correct an inherently unbalanced circuit. Excellent performance over a wide frequency range has proven difficult with this approach.

The AD8138A uses two feedback loops to separately control the differential and common-mode output voltages. The differential feedback, set with external resistors, controls only the differential output voltage. The common-mode feedback controls only the common-mode output voltage. This architecture makes it easy to arbitrarily set the output common-mode level. It is forced, by internal common-mode feedback, to be equal to the voltage applied to the  $V_{OCM}$  input, without affecting the differential output voltage.

The AD8138A architecture results in outputs that are highly balanced over a wide frequency range without requiring tightly matched external components. The common-mode feedback loop forces the signal component of the output common-mode

voltage to be zeroed. The result is nearly perfectly balanced differential outputs of identical amplitude and exactly 180° apart in phase.

### ANALYZING AN APPLICATION CIRCUIT

The AD8138A uses high open-loop gain and negative feedback to force its differential and common-mode output voltages in such a way as to minimize the differential and common-mode error voltages. The differential error voltage is defined as the voltage between the differential inputs labeled +IN and –IN in Figure 42. For most purposes, this voltage can be assumed to be zero. Similarly, the difference between the actual output common-mode voltage and the voltage applied to  $V_{OCM}$  can also be assumed to be zero. Starting from these two assumptions, any application circuit can be analyzed.

### SETTING THE CLOSED-LOOP GAIN

Neglecting the capacitors ( $C_F$ ), the differential-mode gain of the circuit in Figure 42 can be determined by

$$\left| \frac{V_{OUT, dm}}{V_{OUT, dm}} \right| = \frac{R_F^S}{R_G^S}$$

This assumes the input resistors,  $R_G^S$ , and feedback resistors,  $R_F^S$ , on each side are equal.

### ESTIMATING THE OUTPUT NOISE VOLTAGE

Similar to the case of a conventional op amp, the differential output errors (noise and offset voltages) can be estimated by multiplying the input referred terms at +IN and –IN by the circuit noise gain. The noise gain is defined as

$$G_N = 1 + \left( \frac{R_F}{R_G} \right)$$

To compute the total output referred noise for the circuit of Figure 42, consideration must also be given to the contribution of the Resistors  $R_G$  and  $R_F$ . Refer to Table 8 for the estimated output noise voltage densities at various closed-loop gains.

Table 8.

| Gain | $R_G$ ( $\Omega$ ) | $R_F$ ( $\Omega$ ) | Bandwidth –3 dB | Output Noise AD8138A Only | Output Noise AD8138A + $R_G$ , $R_F$ |
|------|--------------------|--------------------|-----------------|---------------------------|--------------------------------------|
| 1    | 499                | 499                | 320 MHz         | 10 nV/ $\sqrt{\text{Hz}}$ | 11.6 nV/ $\sqrt{\text{Hz}}$          |
| 2    | 499                | 1.0 k              | 180 MHz         | 15 nV/ $\sqrt{\text{Hz}}$ | 18.2 nV/ $\sqrt{\text{Hz}}$          |
| 5    | 499                | 2.49 k             | 70 MHz          | 30 nV/ $\sqrt{\text{Hz}}$ | 37.9 nV/ $\sqrt{\text{Hz}}$          |
| 10   | 499                | 4.99 k             | 30 MHz          | 55 nV/ $\sqrt{\text{Hz}}$ | 70.8 nV/ $\sqrt{\text{Hz}}$          |

# AD8138A

When using the AD8138A in gain configurations where

$$\frac{R_F}{R_G}$$

of one feedback network is unequal to

$$\frac{R_F}{R_G}$$

of the other network, there is a differential output noise due to input-referred voltage in the  $V_{OCM}$  circuitry. The output noise is defined in terms of the following feedback terms (refer to Figure 42):

$$\beta_1 = \frac{R_G}{R_F + R_G}$$

for –OUT to +IN loop, and

$$\beta_2 = \frac{R_G}{R_F + R_G}$$

for +OUT to –IN loop. With these defined

$$V_{nOUT, dm} = 2V_{nIN, V_{OCM}} \left[ \frac{\beta_1 - \beta_2}{\beta_1 + \beta_2} \right]$$

where  $V_{nOUT, dm}$  is the output differential noise, and  $V_{nIN, V_{OCM}}$  is the input-referred voltage noise in  $V_{OCM}$ .

## THE IMPACT OF MISMATCHES IN THE FEEDBACK NETWORKS

As previously mentioned, even if the external feedback networks ( $R_F/R_G$ ) are mismatched, the internal common-mode feedback loop still forces the outputs to remain balanced. The amplitudes of the signals at each output remains equal and 180° out of phase. The input-to-output differential-mode gain varies proportionately to the feedback mismatch, but the output balance is unaffected.

Ratio matching errors in the external resistors result in a degradation of the ability of the circuit to reject input common-mode signals, much the same as for a four-resistor difference amplifier made from a conventional op amp.

In addition, if the dc levels of the input and output common-mode voltages are different, matching errors result in a small differential-mode output offset voltage. For the  $G = +1$  case, with a ground referenced input signal and the output common-mode level set for 2.5 V, an output offset of as much as 25 mV (1% of the difference in common-mode levels) can result if 1% tolerance resistors are used. Resistors of 1% tolerance result in a worst-case input CMRR of about 40 dB, worst-case differential-mode output offset of 25 mV due to 2.5 V level shift, and no significant degradation in the output balance error.

## CALCULATING THE INPUT IMPEDANCE OF AN APPLICATION CIRCUIT

The effective input impedance of a circuit such as the one in Figure 42, at +IN and –IN, depends on whether the amplifier is driven by a single-ended or differential signal source. For balanced differential input signals, the input impedance ( $R_{IN, dm}$ ) between the inputs (+IN and –IN) is simply

$$R_{IN, dm} = 2 \times R_G$$

In the case of a single-ended input signal (for example, if –IN is grounded and the input signal is applied to +IN), the input impedance becomes

$$R_{IN, dm} = \left( \frac{R_G}{1 - \frac{R_F}{2 \times (R_G + R_F)}} \right)$$

The input impedance of the circuit is effectively higher than for a conventional op amp connected as an inverter because a fraction of the differential output voltage appears at the inputs as a common-mode signal, partially bootstrapping the voltage across Input Resistor  $R_G$ .

## INPUT COMMON-MODE VOLTAGE RANGE IN SINGLE-SUPPLY APPLICATIONS

The AD8138A is optimized for level shifting ground referenced input signals. For example, for a single-ended input, this implies that the voltage at –IN in Figure 42 is 0 V when the negative power supply voltage of the amplifier (at  $V_-$ ) is also set to 0 V.

## SETTING THE OUTPUT COMMON-MODE VOLTAGE

The  $V_{OCM}$  pin of the AD8138A is internally biased at a voltage approximately equal to the midsupply point (which is the average value of the voltages on  $V_+$  and  $V_-$ ). Relying on this internal bias results in an output common-mode voltage that is within about 100 mV of the expected value.

In cases where more accurate control of the output common-mode level is required, it is recommended that an external source, or resistor divider (made up of 10 kΩ resistors), be used. The output common-mode offset listed in the Specifications section assumes the  $V_{OCM}$  input is driven by a low impedance voltage source.

## DRIVING A CAPACITIVE LOAD

A purely capacitive load can react with the pin and bond wire inductance of the AD8138A, resulting in high frequency ringing in the pulse response. One way to minimize this effect is to place a small capacitor across each of the feedback resistors. The added capacitance should be small to avoid destabilizing the amplifier. An alternative technique is to place a small resistor in series with the outputs of the amplifier, as shown in Figure 40.

## LAYOUT, GROUNDING, AND BYPASSING

As a high speed part, the AD8138A is sensitive to the PCB environment in which it has to operate. Realizing its superior specifications requires attention to various details of high speed PCB design.

The first requirement is for a solid ground plane that covers as much of the board area around the AD8138A as possible. The only exception to this is to keep the two input pins (Pin 1 and Pin 8) a few millimeters from the ground plane, and remove the ground from both the inner layers and the opposite side of the board under the input pins. This minimizes the stray capacitance on these nodes and helps preserve the gain flatness vs. frequency.

Bypass the power supply pins as close as possible to the device to the nearby ground plane using high frequency ceramic chip capacitors. This bypassing should have a capacitance value of 0.01  $\mu\text{F}$  to 0.1  $\mu\text{F}$  for each supply. Farther away, provide low frequency bypassing with 10  $\mu\text{F}$  tantalum capacitors from each supply to ground.

To avoid parasitic effects, keep the signal routing short and direct. Wherever there are complementary signals, provide a symmetrical layout to the extent possible to maximize the balance performance. When running differential signals over a long distance, keep the traces on the PCB close together, or twist together any differential wiring to minimize the area of the loop that is formed. This reduces the radiated energy and makes the circuit less susceptible to interference.

## BALANCED TRANSFORMER DRIVER

Transformers are among the oldest devices used to perform a single-ended-to-differential conversion (and vice versa). Transformers can also perform the additional functions of galvanic isolation, step-up or step-down of voltages, and impedance transformation. For these reasons, transformers always find uses in certain applications.

However, when driving the transformer in a single-ended manner, there is an imbalance at the output due to the parasitics inherent in the transformer. The primary (or driven) side of the transformer has one side at dc potential (usually ground), while the other side is driven. This can cause problems in systems that require good balance of the transformer's differential output signals.

If the interwinding capacitance ( $C_{STRAY}$ ) is assumed to be uniformly distributed, a signal from the driving source couples to the secondary output terminal that is closest to the driven side of the primary. On the other hand, no signal is coupled to the opposite terminal of the secondary winding because its nearest primary terminal is not driven (see Figure 43). The exact amount of this imbalance depends on the particular parasitics of the transformer, but is mostly a problem at higher frequencies.

The balance of a differential circuit can be measured by connecting an equal-valued resistive voltage divider across the differential outputs and then measuring the center point of the circuit with respect to ground. Because the two differential outputs are supposed to be of equal amplitude, but 180° opposite phase, there should be no signal present for perfectly balanced outputs.

The circuit in Figure 43 shows a Mini-Circuits® T1-6T transformer connected with its primary driven single-endedly and the secondary side connected with a precision voltage divider across its terminals. The voltage divider consists of two 500 Ω, 0.005% precision resistors. The voltage,  $V_{UNBAL}$ , which is also equal to the ac common-mode voltage, is a measure of how closely the outputs are balanced.

Figure 45 compares the transformer being driven single-endedly by a signal generator with the same transformer being driven differentially using an AD8138A. The top signal trace of Figure 45 shows the balance of the single-ended configuration, whereas the bottom signal trace shows the differentially driven balance response. The 100 MHz balance is 35 dB better when using the AD8138A.

The well-balanced outputs of the AD8138A provide a drive signal to each of the primary inputs of the transformer that are of equal amplitude and 180° out of phase. Therefore, depending on how the polarity of the secondary is connected, the signals that conduct across the interwinding capacitance either both assist the transformer's secondary signal equally or both buck the secondary signals. In either case, the parasitic effect is symmetrical and provides a well-balanced transformer output (see Figure 45).

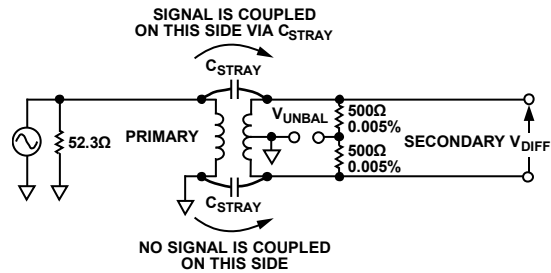

Figure 43. Transformer Single-Ended-to-Differential Converter Is Inherently Imbalanced

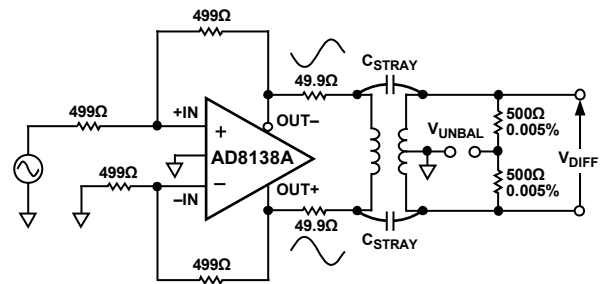

Figure 44. AD8138A Forms a Balanced Transformer Driver

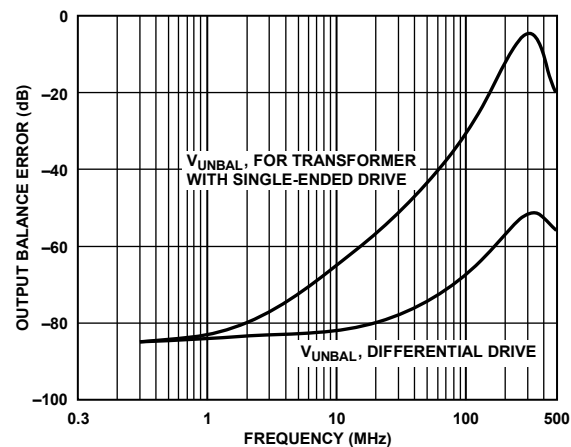

Figure 45. Output Balance Error for Circuits of Figure 43 and Figure 44

## HIGH PERFORMANCE ADC DRIVING

The circuit in Figure 46 shows a simplified front-end connection for an AD8138A driving an AD9224, a 12-bit, 40 MSPS ADC. The ADC works best when driven differentially, which minimizes its distortion. The AD8138A eliminates the need for a transformer to drive the ADC and performs single-ended-to-differential conversion, common-mode level shifting, and buffering of the driving signal.

The positive and negative outputs of the AD8138A are connected to the respective differential inputs of the AD9224 via a pair of 49.9  $\Omega$  resistors to minimize the effects of the switched-capacitor front end of the AD9224. For best distortion performance, it runs from supplies of  $\pm 5$  V.

The AD8138A is configured with unity gain for a single-ended input to a differential output. The additional 23  $\Omega$  (523  $\Omega$  total) at the input to  $-IN$  is to balance the parallel impedance of the 50  $\Omega$  source and its 50  $\Omega$  termination that drives the noninverting input.

The signal generator has a ground referenced, bipolar output, that is, it drives symmetrically above and below ground. Connecting  $V_{OCM}$  to the CML pin of the AD9224 sets the output common-mode of the AD8138A at 2.5 V, which is the midsupply level for the AD9224. This voltage is bypassed by a 0.1  $\mu$ F capacitor.

The full-scale analog input range of the AD9224 is set to 4 V p-p by shorting the SENSE terminal to AVSS. This has been determined to be the scaling that provides minimum harmonic distortion.

For the AD8138A to swing at 4 V p-p, each output swings 2 V p-p while providing signals that are 180° out of phase. With a common-mode voltage at the output of 2.5 V, each AD8138A output swings between 1.5 V and 3.5 V.

A ground referenced 4 V p-p, 5 MHz signal at  $IN+$  was used to test the circuit in Figure 46. When the combined device circuit was run with a sampling rate of 20 MSPS, the spurious-free dynamic range (SFDR) was measured at  $-85$  dBc.

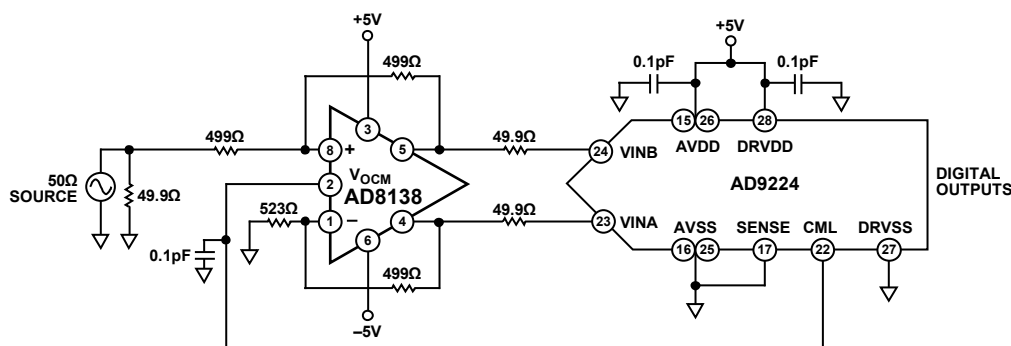

Figure 46. AD8138A Driving an AD9224, a 12-Bit, 40 MSPS ADC

01073-045

## 3 V OPERATION

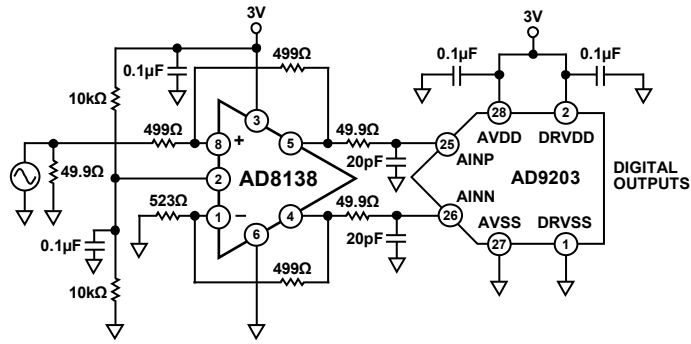

Figure 47. AD8138A Driving an AD9203, a 10-Bit, 40 MSPS ADC

The circuit in Figure 47 shows a simplified front-end connection for an AD8138A driving an AD9203, a 10-bit, 40 MSPS ADC that is specified to work on a single 3 V supply. The ADC works best when driven differentially to make the best use of the signal swing available within the 3 V supply. The appropriate outputs of the AD8138A are connected to the appropriate differential inputs of the AD9203 via a low-pass filter.

The AD8138A is configured for unity gain for a single-ended input to a differential output. The additional 23 Ω at the input to -IN is to balance the impedance of the 50 Ω source and its 50 Ω termination that drives the noninverting input.

The signal generator has ground referenced, bipolar output, that is, it can drive symmetrically above and below ground. Even though the AD8138A has ground as its negative supply, it can still function as a level shifter with such an input signal.

The output common mode is brought to midsupply by the voltage divider that biases  $V_{OCM}$ . In this way, the AD8138A provides dc coupling and level shifting of a bipolar signal without inverting the input signal.

The low-pass filter between the AD8138A and the AD9203 provides filtering that helps to improve the signal-to-noise ratio (SNR). Lower noise can be realized by lowering the pole frequency, but the bandwidth of the circuit is lowered.

The circuit was tested with a -0.5 dBFS signal at various frequencies. Figure 48 shows a plot of the total harmonic distortion (THD) vs. frequency at signal amplitudes of 1 V and 2 V differential drive levels.

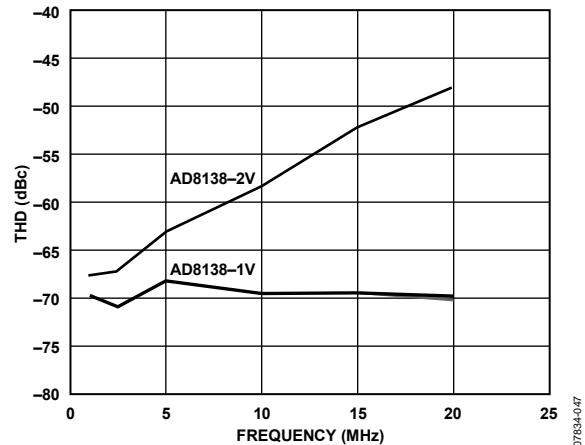

Figure 48. AD9203 THD @ -0.5 dBFS AD8138A

Figure 49 shows the signal-to-noise-and distortion (SINAD) under the same conditions as those tested in Figure 48. For the smaller signal swing, the AD8138A performance is quite good, but its performance degrades when trying to swing too close to the supply rails.

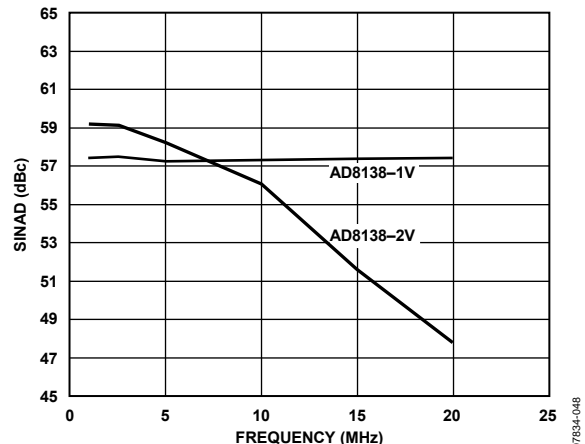
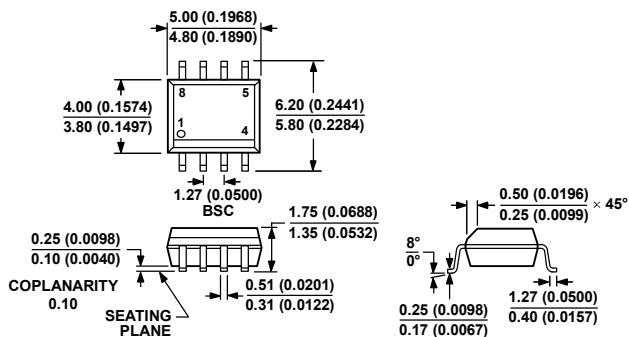

Figure 49. AD9203 SINAD @ -0.5 dBFS AD8138A

### OUTLINE DIMENSIONS



COMPLIANT TO JEDEC STANDARDS MS-012-AA  
 CONTROLLING DIMENSIONS ARE IN MILLIMETERS; INCH DIMENSIONS  
 (IN PARENTHESES) ARE ROUNDED-OFF MILLIMETER EQUIVALENTS FOR  
 REFERENCE ONLY AND ARE NOT APPROPRIATE FOR USE IN DESIGN.

012407-A

Figure 50. 8-Lead Standard Small Outline Package [SOIC]  
 (R-8)  
 Dimensions shown in millimeters and (inches)

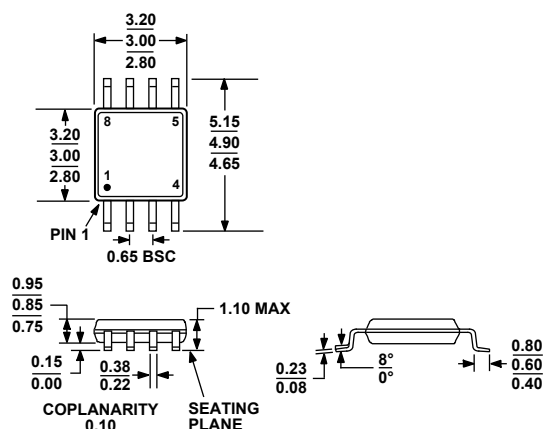

COMPLIANT TO JEDEC STANDARDS MO-187-AA

Figure 51. 8-Lead Mini Small Outline Package [MSOP]  
 (RM-8)  
 Dimensions shown in millimeters

### ORDERING GUIDE

| Model                       | Temperature Range | Package Description            | Package Option | Branding |
|-----------------------------|-------------------|--------------------------------|----------------|----------|
| AD8138AARMZ <sup>1</sup>    | -40°C to +85°C    | 8-Lead MSOP                    | RM-8           | H1R      |
| AD8138AARMZ-R7 <sup>1</sup> | -40°C to +85°C    | 8-Lead MSOP, 7" Tape and Reel  | RM-8           | H1R      |
| AD8138AARMZ-RL <sup>1</sup> | -40°C to +85°C    | 8-Lead MSOP, 13" Tape and Reel | RM-8           | H1R      |
| AD8138AARZ <sup>1</sup>     | -40°C to +85°C    | 8-Lead SOIC                    | R-8            |          |
| AD8138AARZ-R7 <sup>1</sup>  | -40°C to +85°C    | 8-Lead SOIC, 7" Tape and Reel  | R-8            |          |
| AD8138AARZ-RL <sup>1</sup>  | -40°C to +85°C    | 8-Lead SOIC, 13" Tape and Reel | R-8            |          |

<sup>1</sup> Z = RoHS Compliant Part.

**AD8138A**

**NOTES**



# Mouser Electronics

Authorized Distributor

Click to View Pricing, Inventory, Delivery & Lifecycle Information:

[Analog Devices Inc.:](#)

[AD8138AARZ](#) [AD8138AARMZ-R7](#) [AD8138AARZ-R7](#) [AD8138AARMZ](#) [AD8138AARZ-RL](#) [AD8138AAR-EBZ](#)  
[AD8138AARMZ-RL](#)