



For full product information, visit www.sti.com. Use the SpeedSpec Code or scan the QR Code for quick access to the specific web page.

Enabling Grip Switch with Distinct Feel for Three Easily Discernible Positions

- The difficult task of configuring safety circuits is now easily achieved by combining the A4EG with the G9SX-GS.
- In addition to the standard models, the lineup also includes models with an emergency stop switch and models with a momentary operation switch.
- An optional Holding Key (sold separately) provides a versatile method for selecting modes.
- Equipped with conduit connector.
- A Rapid Delivery Product: Select models are available for shipment today or within 3 to 5 days.



Specifications

Standards and EC Directives

Compliance with EC Directives and International Standards

- Low Voltage Directive
- GS-ET-22

Certified Standards

Certifying body	Standard	File No.
TÜV SÜD	EN 60947-5-1 (certified direct opening)	Ask your Omron representative.
UL *	UL 508, CSA C22.2 No.14	E76675
CQC (CCC)	GB 14048.5	Pending approval

Certification for CSA C22.2 No. 14 by UL is indicated by the registration mark.

Certified Standard Ratings (Enabling Switch Section)

TÜV (EN 60947-5-1)

Utilization category	AC-15	DC-13
Rated operating current (Ie)	0.75 A	0.55 A
Rated operating voltage (Ue)	240 V	125 V

Note: Use a 10-A fuse type gI or gG that conforms to IEC 60269 as the short-circuit protection device. The fuse is not built into the Switch

UL/CSA (UL 508, CSA C22.2 No.14), CCC (GB 14048.5)

- 24 VDC, 0.3 A (inductive load)
- 125 VAC, 1 A (resistive load)

Ratings

	Enabling switch	Emergency stop switch (A4EG-BE2R041 only)	Pushbutton (A4EG-BM2B041 only)
Rated insulation voltage	250 V		---
Rated ON current	2.5 A	5 A	0.1 A
Rated load	24 VDC, 0.3 A (inductive load) 125 VAC, 1 A (resistive load) EN certification rating: AC-15 0.75 A/240 V DC-13 0.55 A/125 V	General rating: 125 VAC, 5 A (resistive load) 250 VAC, 3 A (resistive load) 30 VDC, 3 A (resistive load) UL and cUL rating: 125 VAC, 5A (inductive load, power factor: 0.75 to 0.8) 250 VAC, 3 A (inductive load, power factor: 0.75 to 0.8) 30 VDC, 3 A (resistive load) EN certification rating: AC-12 3 A/250 V DC-12 3 A/30 V	General rating: 125 VAC, 0.1 A (resistive load) 8 VDC, 0.1 A (resistive load) 14 VDC, 0.1 A (resistive load) 30 VDC, 0.1 A (resistive load) UL and cUL rating: 125 VAC, 0.1 A (resistive load) 30 VDC, 0.1 A (resistive load) EN certification rating: AC-12 0.1 A/125 V DC-12 0.1 A/30 V
Minimum applicable load	24 VDC, 4 mA		5 VDC, 1 mA

Select models are available for Rapid Delivery.

Visit this product on www.sti.com for details..

Specifications

Characteristics

	Enabling Switch	Emergency Stop Switch (A4EG-BE2R041 only)	Pushbutton (A4EG-BM2B041 only)
Degree of Protection:	IP66	IP65	IP65
Operating Section Strength:	Operating direction: 200 N, 1 min.	Operating direction: 367 N, 1 min. Rotating direction: 0.49 N-m, 1 min.	Operating direction: 50 N, 1 min.
Cable Pull Strength:	30 N, 1 min.	30 N, 1 min.	30 N, 1 min.
Allowable Operating Frequency			
Electrical:	20 operations/min. max.	10 operations/min. max. (set/reset for one operation)	60 operations/min. max.
Mechanical:	20 operations/min. max.	10 operations/min. max. (set/reset for one operation)	120 operations/min. max.
Electrical Durability (rated load):	100,000 operations min.	100,000 operations min. (set/reset for one operation)	100,000 operations min.
Mechanical Durability:	OFF-ON-OFF (direct opening): 100,000 operations min. OFF-ON: 1,000,000 operations min.	100,000 operations min. (set/reset for one operation)	2,000,000 operations min.
Dielectric Strength:			
Between terminals of the same polarity	2,500 VAC, 50/60 Hz, 1 min. (impulse voltage)	1,000 VAC, 50/60 Hz, 1 min.	1,000 VAC, 50/60 Hz, 1 min.
Between terminals of different polarities	2,500 VAC, 50/60 Hz, 1 min. (impulse voltage)	2,000 VAC, 50/60 Hz, 1 min.	2,000 VAC, 50/60 Hz, 1 min.
Between each terminal and non-current carrying metallic parts	2,500 VAC, 50/60 Hz, 1 min. (impulse voltage)	2,000 VAC, 50/60 Hz, 1 min.	2,000 VAC, 50/60 Hz, 1 min.
Insulation Resistance:	100 MΩ min. (at 500 VDC)		
Vibration Resistance:	Malfunction: 1.5 mm double amplitude, 10 to 55 Hz		
Shock Resistance:	Malfunction: 150 m/s ² max.		
Ambient Operating Temperature:	-10 to 55°C (with no icing or condensation)		
Ambient Operating Humidity:	35% to 85%		
Ambient Storage Temperature:	-25 to 65°C (with no icing or condensation)		
Protection Against Electric Shock:	Class II (double insulation)		
Pollution Degree (Operating Environment):	3 (EN 60947-5-1)		
Conditional Short-Circuit Current:	100 A (EN 60947-5-1)		

Note: The timing of contact outputs for two or more circuits is not synchronized. Confirm performance before application. Specifications are subject to change without notice.

 **Select models are available for Rapid Delivery.**

Visit this product on www.sti.com for details..

Structure and Nomenclature

Structure

A4EG-C000041

A4EG-BE2R041
A4EG-BM2B041

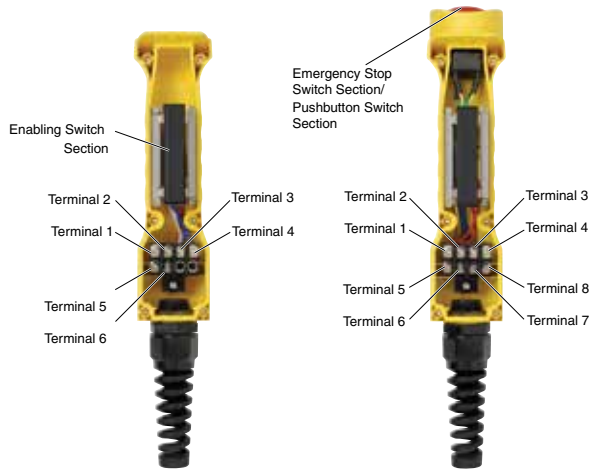

Contact Forms

Operating Patterns

A4EG-C000041

Operation	Terminal Number	Position 1	Position 2	Position 3
Enable output	1 to 2			
	3 to 4			
Grip output	5 to 6			

A4EG-BE2R041

Operation	Terminal Number	Position 1	Position 2	Position 3
Enable output	1 to 2			
	3 to 4			

Pushbutton Switch	Terminal Number	Operation	Contact
Emergency stop switch output	5 to 6	Operation (push)	ON → OFF
	7 to 8	Reset (turn reset)	OFF → ON

A4EG-BM2B041

Operation	Terminal Number	Position 1	Position 2	Position 3
Enable output	1 to 2			
	3 to 4			

Pushbutton Switch	Terminal Number	Operation	Contact
Pushbutton switch output	5 to 6 (pushbutton switch A)*	Push	OFF → ON
	7 to 8 (pushbutton switch B)*	Push	OFF → ON

*Refer to Dimensions for information on the positions of pushbutton switches A and B.

<input type="checkbox"/>	Open	ON: Closed
<input checked="" type="checkbox"/>	Closed	OFF: Open

- Notes: 1. The contact ON/OFF timing is not synchronized. Confirm performance before application.
2. Direct opening only during grip.

Three Positions: OFF – ON – OFF

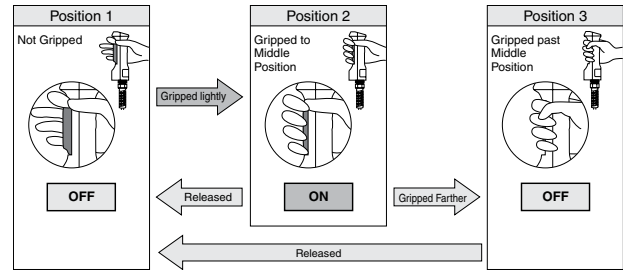

Contact Configurations

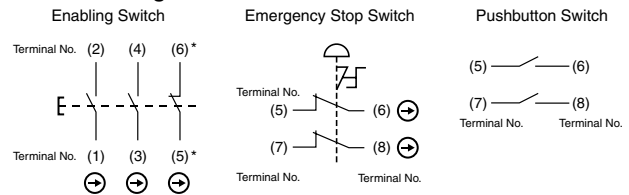

*Terminal No. (5), (6): A4EG-C000041 only.

Operating Characteristics

Chart (Enabling Switch Section)

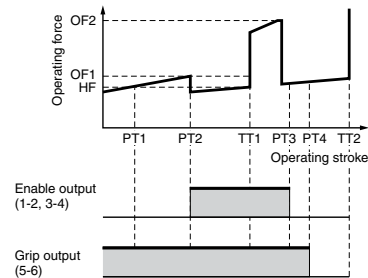

Operating Stroke (Enabling Switch Section)

Operating Characteristics	Specified Value
Enable output (ON)	PT2 max. 3.6 mm
Max. enable holding position	TT1 Approx. 4.2 mm
Enable direct opening position	PT3 max. 6.0 mm
Max. stroke	TT2 Approx. 6.7 mm

Operating Force (Enabling Switch Section: Reference Values)

Operating Characteristics	Specified Value
Enable operating force	OF1 max. 14 N
Enable holding force	HF* Approx. 8 N
Grip operating force	OF2 max. 40 N

*HF: Holding force

Operating Force (Emergency Stop Switch Section: Reference Values)

Operating Characteristics	Specified Value
Operating force	OF max. 14.7 N
Reset force	RF max. 0.1 N·m

Operating Force (Pushbutton Switch Section: Reference Value)

Operating Characteristics	Specified Value
Operating force	OF max. 4 N

Dimensions

(mm)

Structure (continued)

A4EG-BM2B041

A4EG-C000041: Dimensions are similar to A4EG-BM2B041 without Pushbutton Switch.

A4EG-BE2R041: Dimensions are similar to A4EG-BM2B041. The A4EG-BE2R041 has an Emergency Stop Switch instead of a Pushbutton Switch. See "Installation Manual" for A4EG-C000041 and A4EG-BE2R041 dimensions.

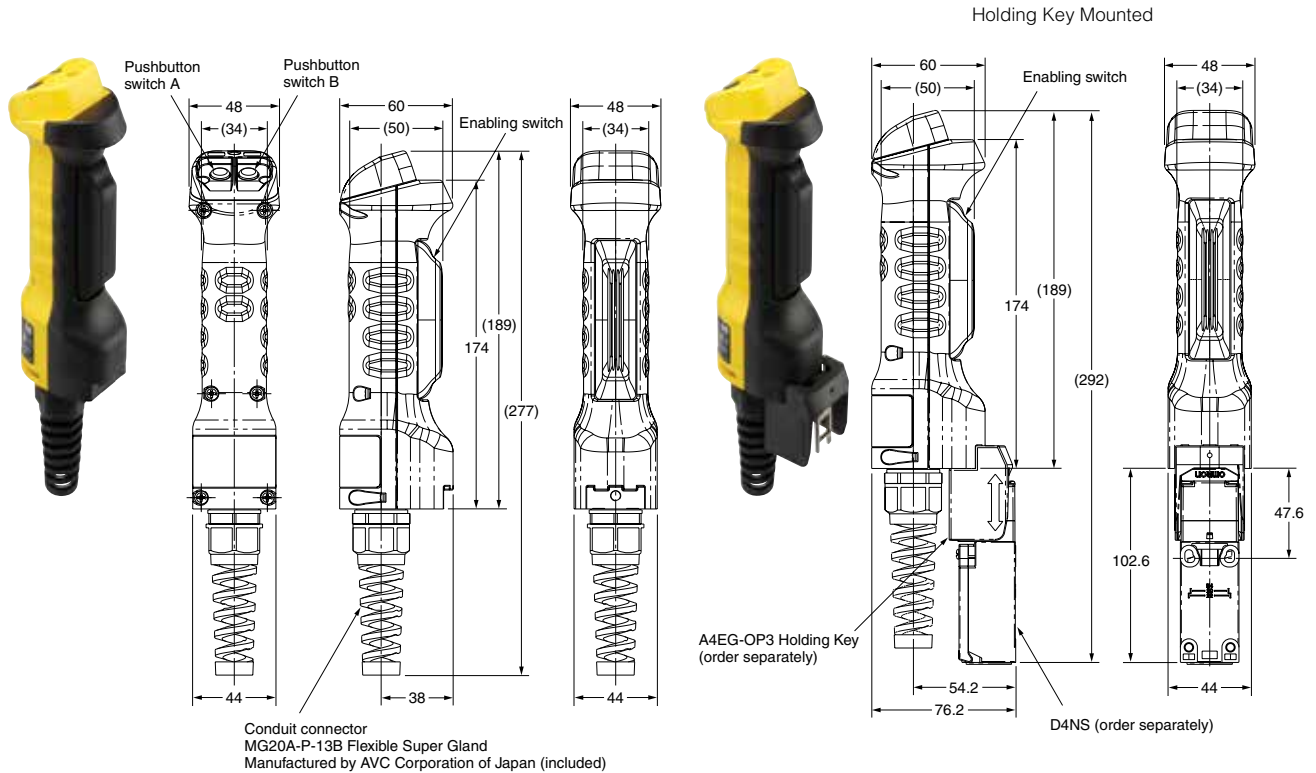

Accessories (Order Separately)

Rubber Cover (Replacement Part)
A4EG-OP1



Mounting Bracket (for Securing the A4EG)
A4EG-OP2

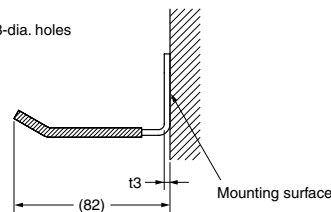
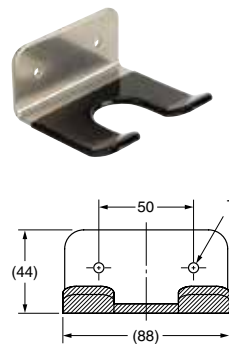

Enabling Grip Switch Mounted

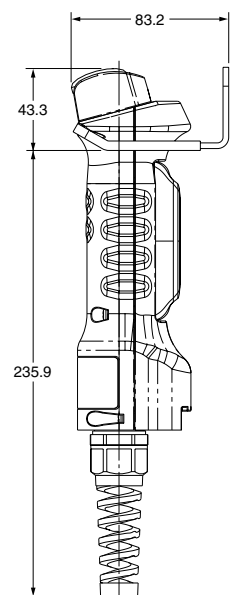

Holding Key
A4EG-OP3



Note: The screws are not included.

M

Application Example

Wiring Example

Settings

(For details, refer to section 3 of the G9SX User's Guide (Cat. No. Z255).)
 G9SX-BC: Manual reset, cross fault detection: ON (category 4 wiring)
 G9SX-GS: Manual reset, cross fault detection: ON (category 4 wiring),
 logical AND connection setting: AND
 ON-delay time setting: Time is set.
 Switching mode: Manual
 External indicator diagnosis: Enabled

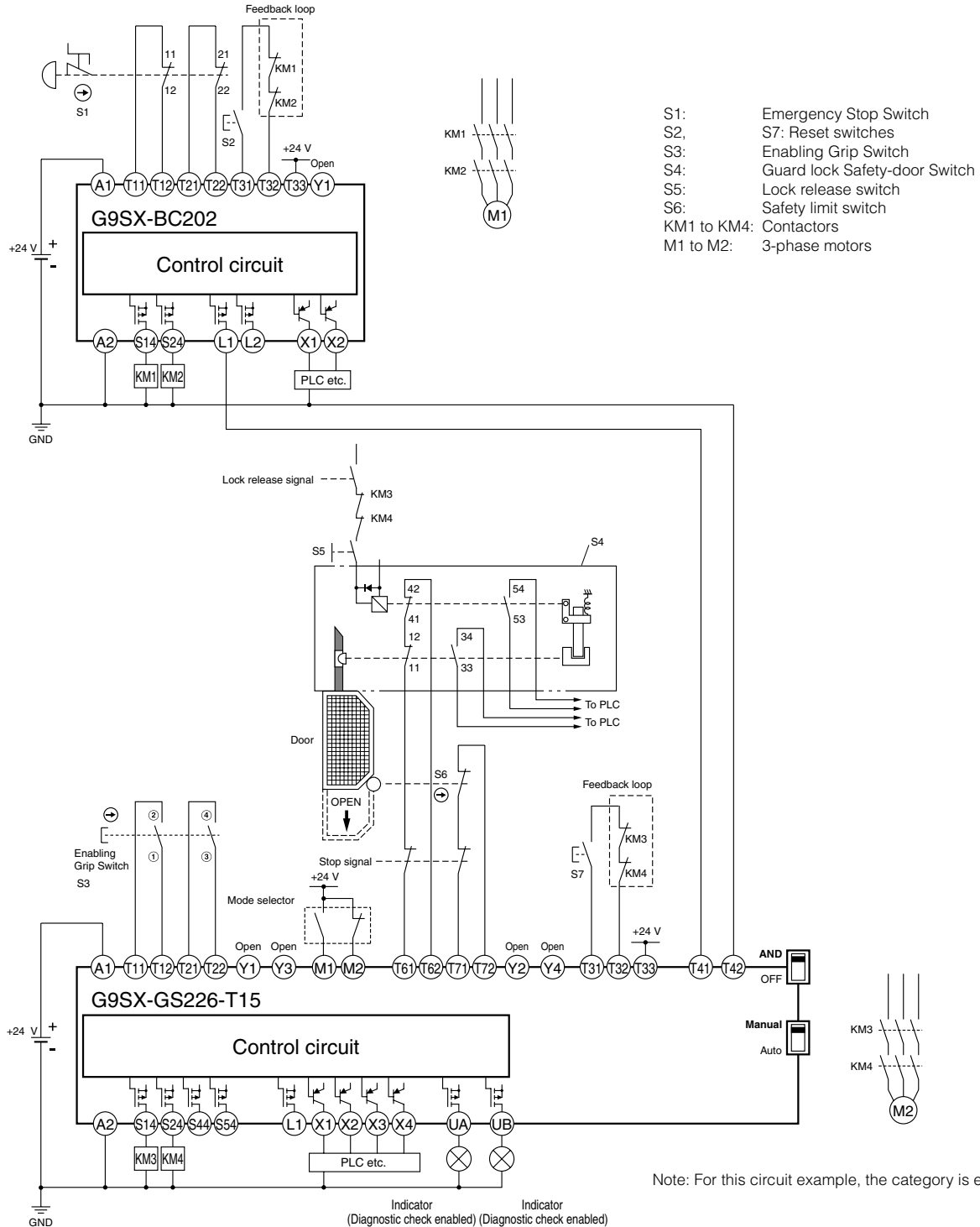

Wiring Example



M

Ordering

Enabling Grip Switches

Appearance	Contact Form			Model
	Enabling Switch	Monitor Switch	Pushbutton Switch	
	Two contacts	1 NC (grip output)	None	A4EG-C000041
	Two contacts	None	Emergency stop switch (2 NC)	A4EG-BE2R041
	Two contacts	None	Momentary operation switch (2 NO)	A4EG-BM2B041

Accessories (Order Separately)

Appearance	Item	Model
	Rubber Cover	A4EG-OP1
	Mounting Bracket (for securing the A4EG)	A4EG-OP2
	Holding Key	A4EG-OP3

M

 Select models are available for Rapid Delivery.

Visit this product on www.sti.com for details..

Ordering (continued)

Cabling Accessories (Order Separately)

Appearance	Cables	Model
	SC09-9M340, cable, 4-pin Micro Male, 10 m	44509-0340
	SC09-9M330, cable, 4-pin Mini Male, 10 m	44509-0330
	SC09-9M320, cable, 8-pin Mini Male, 9 m	44509-0320
	SC09-9M310, cable, 10-pin Mini Male, 9 m	44509-0310
Extension Cables		
	SC09-10M140, Extension cord, 4-pin male mini / 4-pin female mini, 10 m	44509-0140
	SC09-10M142, Extension cord, 4-pin male micro / 4-pin female micro, 10 m	44509-0142
	SC09-10M180, Extension cord, 8-pin male mini / 8-pin female mini, 10 m	44509-0180
	SC09-10M110, Extension cord, 10-pin male mini / 10-pin female mini, 10 m	44509-0110
Cable Receptacles		
	SC09-10M540, 4-pin Female Mini, 1/2" NPT, 18 AWG, 24 in. leads	44509-0540
	SC09-10M542, 4-pin Female Micro, 1/2" NPT, 18 AWG, 24 in. leads	44509-0542
	SC09-10M580, 8-pin Female Mini, 1/2" NPT, 18 AWG, 24 in. leads	44509-0580
	SC09-10M510, 10-pin Female Mini, 1/2" NPT, 18 AWG, 24 in. leads	44509-0510
Couplings		
	MIN1-AC, Adapter Coupling (for use with 4-pin mini cables and extension cables)	44509-0210
	MIN2-AC, Adapter Coupling (for use with 8-pin mini cables and extension cables)	44509-0220
	MIN3-AC, Adapter Coupling (for use with 10-pin mini cables and extension cables)	44509-0230
Shorting Plugs		
	SC09-SP40, 4-pin male mini style shorting plug (pins 1-2 and 3-4 are shorted)	44509-0640
	SC09-SP42, 4-pin male micro style shorting plug (pins 1-2 and 3-4 are shorted)	44509-0642
	SC09-SP80, 8-pin male mini style shorting plug (pins 1-2 and 3-4 are shorted)	44509-0680
	SC09-SP10, 10-pin male mini style shorting plug (pins 1-2 and 3-4 are shorted)	44509-0610

M



Enabling Switch devices with pre-wired connectors and cables are available in the ESD5020 series of Enabling Switch devices and accessories. Please visit www.sti.com for more information.

 Select models are available for Rapid Delivery.

Visit this product on www.sti.com for details..