

Panasonic
ideas for life



48 mm



FP-e Series
Programmable Controllers

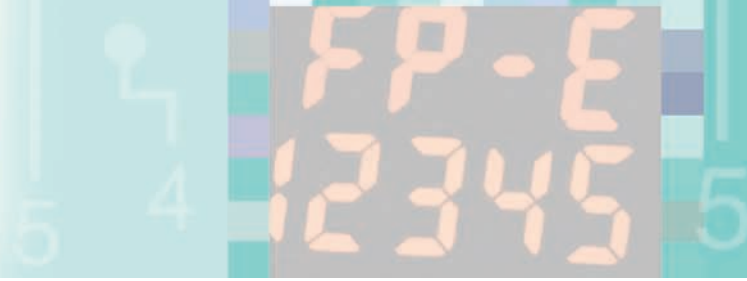

FP-e Series

The universal compact PLC

Do this, do that, do everything. **All in One!**



● 3-color Display

Simple characters and numerical values can be displayed. Simple messages as well as timer/counter settings and elapsed values can also be displayed.

● Built-in operation switch

Setting values can be changed. The operation switch can also be used for input.

● Compact and Space-saving

Panel mountable, little space is taken up on the control panel. The size is only 48 × 48 × 70 mm (behind faceplate).

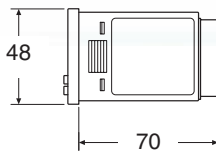

● Matches FP0 intelligence (equivalent to FP0-C14)

● Panel mounted type (in accordance with IP66, IEC standard)

To match panel design, the color can be changed to black.



Same programming tools used as with the FP Series

One programming software for all PLC types

Programming software and cables are common for all FP Series PLCs, so that any program created for the FP Series can be used by the FP-e as well. FPWIN Pro Ver.5 and FPWIN GR from Ver.2.3 offer a dialog to configure the screen display of the FP-e easily. You can check the result of the configuration directly with the display in the dialog.

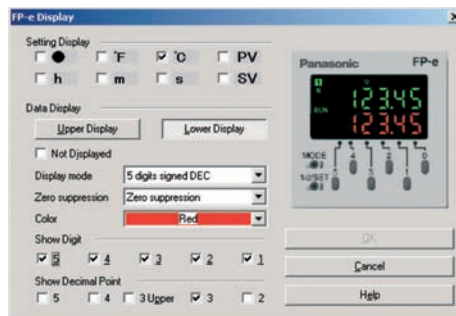

FP-e Series

Optimised for a wide range of applications

Equipped with RS485 and RS232C interfaces

- Up to 99 computer link stations are possible with RS485. (RS485 type)

Up to 32 computer link stations are possible using a C-NET adaptor and up to 99 are possible using a commercially available adaptor. This makes it possible to monitor operation status or perform control.

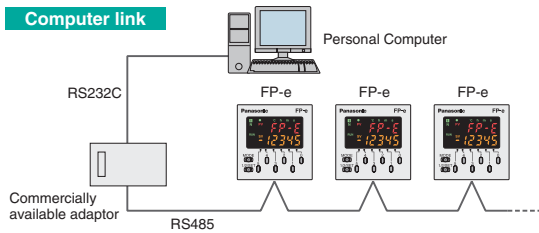

- With RS232C, communication with up to two ports is possible. (RS232C type)

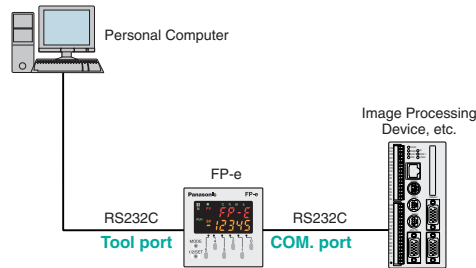

Can even handle temperature control

- Two-point K-type thermocouple (-30 to 300°C) connection is possible. (equipped with thermocouple input)

Can be used in place of a temperature controller or used to control them.

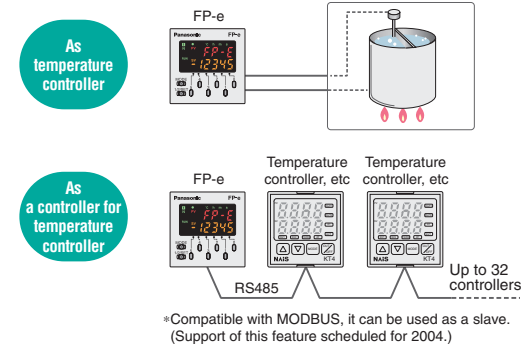

- PWM output function

Equipped with two PWM (pulse-width modulation) outputs, which allow the FP-e to perform simple temperature control.

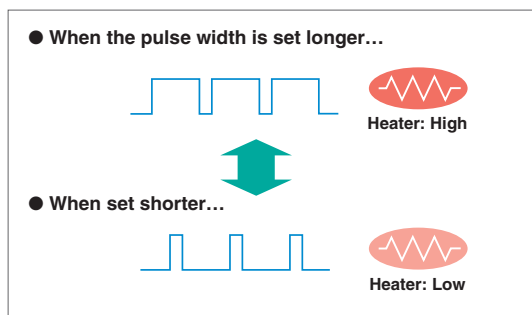

Equipped with high-speed counter for support of 2-axis independent positioning

- Pulse output function

The unit comes equipped with 2 channels for pulse output of up to 10 kHz pulses. Since these two channels can be separately controlled, the FP-e is also suitable for 2-axis independent positioning.

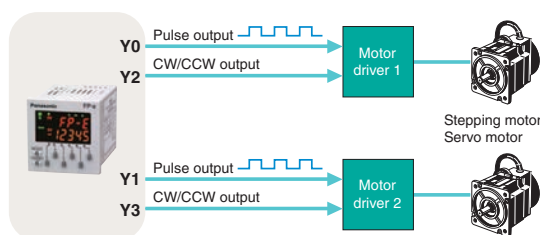

- High-speed counter function

In single phase, the 4-channel total is 10 kHz, and in 2-phase the 2-channel total is 2 kHz total speed, making the suitable for inverter control, and so forth.

(One half for the type with thermocouple input.)

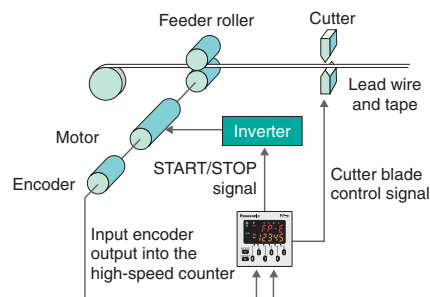



FP-e Control Units

Decisive advantages in its class

FP-e Control Unit

New Born! Advanced Controller!

Timer, Counter, Hour meter, Temperature Controller and PLC in a Unit



■ Features

- 1. 5-character, 2-line, 3-color Display**
Simple characters and numerical values can be displayed. Simple error messages as well as operation instructions and timer/counter set values can be displayed.
- 2. Front Operation Switch**
Timer/Counter set values can be changed using front operation switches. The switches can also be used as input switches (X30 to X3F), which save the need for installing external switches.
- 3. Equivalent to FP0-C14 Intelligence of Small PLCs**
Addition to the functions of programmable controller FP0, pulse output and high-speed counter functions can be used. Other than a tool port, a unit is equipped with COM. port (RS232C/RS485) for communication.
- 4. Easy Programming Using Wizard**
Screen display instructions can be easily created using a programming tool FPWIN GR Wizard.
- 5. Smooth Debug**
Monitoring the memory area data and I/O status facilitates debug using the R (register) and I (I/O monitor) display modes.
- 6. Panel Mounted Type**
The front of a Unit is water-proof (in accordance with IP66, IEC standard).

■ Type

Name	Type	Calendar timer	Thermocouple input	COM. port	Product No.
FP-e control unit	Standard type (RS232C)	Not available	Not available	RS232C	AFPE224300
	Calendar timer type (RS232C)	Available	Not available	RS232C	AFPE224305
	Thermocouple input type (RS232C)	Available	Available	RS232C	AFPE214325
	Standard type (RS485)	Not available	Not available	RS485	AFPE224302
	Thermocouple input type (RS485)	Not available	Available	RS485	AFPE214322

■ Display modes and functions

- 1 N mode**
(Normal mode)

Displays any characters and numerical values, and numerical data can be changed.
- 2 S mode**
(Switch mode)

Can also display characters and numerical values. Operation switches can be used for input.
- 3 R mode**
(Register mode)

Operation memory in the controller can be monitored and its data can be changed.
- 4 I mode**
(I/O monitor mode)

I/O status (X, Y) in the controller can be monitored.

FP-e Series

Specification table

Performance specifications

Model		AFPE224300 Standard type (RS232C)	AFPE224302 Standard type (RS485)	AFPE224305 Calendar timer type (RS232C)	AFPE214325 Thermocouple input type (RS232C)	AFPE214322 Thermocouple input type (RS485)	
Item							
Programming method/Control method		Relay symbol/Cyclic operation					
Number of controllable I/O points	Control unit	14 points [Input: 8, Output: 6 (Tr. NPN: 5/Ry: 1)]			12 points [Input: 6, Output: 6 (Tr. NPN: 5/Ry: 1)]		
	Front switch input	8 points					
Program memory		Built-in EEPROM					
Program capacity		2,720 steps					
Number of instruction	Basic	83					
	High-level	117					
Operation speed		0.9 μs/step (Basic instruction)					
I/O update and Base time		2 ms			Typical 2 to 3 ms Max. 15 ms ^{Note 1)}		
Operation memory points	Relays	Internal relay (R)		1,008 points (R0 to R62F)			
		Special internal relay (R)		64 points (R9000 to R903F)			
		Timer/Counter (T/C)		144 points (Initial setting: 100 timer points, T0 to T99/44 counter points, C100 to C143 ^{Note 2)} Timer range (1 ms, 10ms, 100ms, 1 s): selected by instruction			
	Memory areas	Data register (DT)		1,660 words (DT0 to DT1659)			
		Special data register (DT)		112 words (DT9000 to DT9111)			
Index registers (IX, IY)		2 points					
Differential points		Unlimited number of points					
Master control relay points (MCR)		32 points					
Number of labels (JP and LOOP)		64 labels					
Number of step ladders		128 stages					
Number of subroutines		16 subroutines					
Number of interrupt programs		7 programs (external: 6, internal 1)					
Self-diagnostic function		Watchdog timer, program syntax check, etc.					
Clock/calendar function ^{Note 3)}		Not available			Available (year, month, day, hour, minute, second and day of week) However, this can only be used when a battery has been installed.		
Battery life		Not available			220 days or more (actual usage value: approx. 870 days (25°C) (Periodic replacement interval: 1 year) (Value applies when no power is supplied at all.)		
Pulse catch input		6 points in total (X0 and X1: 50 μs, X2 to X5: 100 μs)					
Interrupt input		6 points in total (X0 and X1: 50 μs, X2 to X5: 100 μs)					
COM. port ^{Note 4)}		RS232C	RS485	RS232C	RS232C	RS485	
Periodical interrupt		0.5 ms to 30 s					
Constant scan		Available					
Password		Available					
Special functions	High-speed counter function	Counter mode: Addition/subtraction (1-phase) ^{Note 5)} - Input points: 4 ch. (Max.)					
		- Max. speed: 10 kHz (total of 4 ch.)		: 5 kHz (total of 4ch.)			
		- Input contact: X0: count input (ch. 0), X1: count input (ch. 1), X2: reset input ^{Note 6)} X3: count input (ch. 2), X4: count input (ch. 3), X5: reset input ^{Note 6)}					
		- Min. input pulse width: X0 and X1: 50 μs (10 kHz)		X0 and X1: 100 μs (5 kHz)			
		X3 and X4: 100 μs (5kHz)					
	Counter mode: 2-phase/individual/direction decision (2-phase) - Input points: 2 ch (Max.)						
	- Max. speed: 2 kHz (total of 2 ch.)		: 1 kHz (total of 2ch.)				
	- Input contact: X0: count input (ch. 0), X1: count input (ch. 0), X2: reset input X3: count input (ch. 2), X4: count input (ch. 2), X5: reset input						
	- Min. input pulse width: X0 and X1: 50 μs (10 kHz)		X0 and X1: 100 μs (5 kHz)				
	X3 and X4: 100 μs (5 kHz)						
Pulse output function	Output points	2 independent points (Y0 and Y1) (No interpolation function)					
	Output frequency	40 Hz to 10 kHz (Y0/Y1: 1-point) ^{Note 7)}			40 Hz to 5 kHz (1-point) 40 Hz to 2.5 kHz (2-point)		
PWM output function	Output points	2 points (Y0 and Y1)					
	Output frequency	Frequency: 0.15 Hz to 1 kHz Duty: 0.1 % to 99.9 %					
Memory backup ^{Note 8)}	Timer	Non-hold type: (all points)					
	Counter	Non-hold type: From set value to C139					
	Counter	Hold type: 4 points (elapsed values) C140 to C143					
	Internal relay	Non-hold type	976 points (R0 to R60F)			61 words (WR0 to WR60)	
		Hold type	32 points (R610 to R62F)			2 words (WR61 to WR62)	
	Data register	Non-hold type	1,652 words (DT0 to DT1651)				
Hold type		8 words (DT1652 to DT1659)					

Note 1) The proportion of timer points to counter points can be changed using a system register.

Note 2) Precision of calendar timer:

- At 0°C/32°F, less than 200 seconds of error per month
- At 25°C/77°F, less than 70 seconds of error per month
- At 55°C/131°F, less than 240 seconds of error per month

Note 3) When using the COM. port for communication, retransmission is recommended.

The RS232C driver IC for the COM. port conforms completely to EIA/TIA-232E and CCITT V.28 standards

Note 4) The max. counting speed (10 kHz) is the counting speed with a rated input voltage of 24 V DC and an ambient temperature of 25°C. The counting speed (frequency) will decrease depending on the voltage and temperature.

Note 5) If the unit is equipped with both reset inputs X0 and X1, X2 serves as the reset input for X1. If X3 and X4 are used, X5 serves as the reset input for X4.

Note 6) When the positioning control instruction "F168" is performed, the maximum output frequency is 9.5 kHz.

Note 7) The program, system registers and the hold type area (internal relay, data register, and timer/counter) are backed up by the built-in EEPROM.

When a battery is replaced with a new one in the FP-e unit with a calendar timer function, settings can be changed without installing a battery. The data cannot be stored even when the settings are changed using the system register.

Note 8) F180 (SCR) and F181 (DSP) instructions are supported from Control FPWIN GR Ver. 2.2 and FPWIN Pro V 4.1.



FP-e Series

Technical data

General specifications

Item	Description	
Rated voltage	24 V DC	
Operating voltage range	21.6 to 26.4 V DC	
Allowed momentary power off time	10 ms	
Ambient temperature	0 to +55°C	
Storage temperature	-20 to +70°C	
Ambient humidity	30 to 85%RH (non-condensing)	
Storage humidity	30 to 85%RH (non-condensing)	
Breakdown voltage	Input terminals (COM, X0 to Xn) Output terminals (Y0 to Y4) ↔ Power supply terminal, Function earth Input terminal (A0, A1) COM. (RS232C) terminal	500 V AC for 1 minute
	Output terminal (Y5) ↔ Power supply terminal, Function earth Input terminal (COM, X0 to Xn, A0, A1) COM. (RS232C) terminal	1500 V AC for 1 minute
	Input terminals (COM, X0 to Xn) ↔ Output terminals (Y0 to Y4)	500 V AC for 1 minute
Insulation resistance	Input terminals (COM, X0 to Xn) Output terminals (Y0 to Y5) ↔ Power supply terminal, Function earth Input terminal (A0, A1) COM. (RS232C) terminal	Min. 100 M? (measured with 500 V DC)
	Input terminals (COM, X0 to Xn) ↔ Output terminals (Y0 to Y5)	
Vibration resistance	10 to 55 Hz, 1 cycle/min. Double amplitude: 0.75 mm, 10 min. on X, Y, and Z axes	
Shock resistance	98 m/s ² or more, 4 times on X, Y, and Z axes	
Noise resistance	1000V (p-p) with pulse widths 50 ns and 1 μs (based on in-house measurements)	
Operating condition	Free from corrosive gases and excessive dust	
Current consumption	200 mA or less (24 V DC)	
Protection	IP66-compliant front section (Only when a rubber packing is used)	
Mass	Approx. 130 g	

DC input specifications (X0 to X7)

Item	Description
Number of input	8 points (6 points for thermocouple input type)
Insulation method	Optical coupler
Rated input voltage	24 V DC
Operating voltage range	21.6 to 26.4 V DC
Rated input current	Approx. 4.3 mA
Input points per common	8 points/common (6 points/common for thermocouple input type) Either the positive or negative of the input power supply can be connected to common terminal
ON voltage/ON current	19.2 V or less/4 mA or less
OFF voltage/OFF current	2.4 V or more/1 mA or more
Input impedance	Approx. 5.1 k Ω (X0, X1) Approx. 5.6 k Ω (X2 to X7)
Response time	50 μ s or less (X0, X1) ^{Note 1)}
	OFF to ON
	100 μ s or less (X2 to X5) ^{Note 1)}
	2 ms or less (X6, X7)
	ON to OFF
	50 μ s or less (X0, X1) ^{Note 1)}
	100 μ s or less (X2 to X5) ^{Note 1)}
	2 ms or less (X6, X7)
Operating mode indicator	LCD display (I/O monitor mode)

Note 1) X0 through X5 are inputs for the high-speed counter and have a fast response time. If used as normal inputs, you should insert a timer in the program as chattering and noise may be interpreted as an input signal. Also, the above specifications apply when the rated input voltage is 24V DC and the temperature is 25°C.

Thermocouple input specifications

Item	Description
Number of input	2 points (CH0: WX1, CH1: WX2)
Temperature sensor type	Thermocouple type K
Input range	-30 to 300°C ^{*1)} (-22 to 572°F)
Accuracy	$\pm 0.5\%$ FS $\pm 1.5^\circ$ C (FS = -30 to 300°C)
Resolution	0.1°C
Conversion time	250 ms/2CH ^{*2)}
Insulation method	Between internal circuit and thermocouple input circuit: noninsulated ^{*3)} Between CH0 and CH1 of thermocouple input: PhotoMOS insulation
Detection function of wire disconnection	Available

*1) Temperature can be measured up to 330°C (626°F). When the measured temperature exceeds 330°C (626°F) or the thermocouple wiring is disconnected, "K20000" is written to the register.

*2) Temperature conversion for thermocouple input is performed every 250 ms. The conversion data is updated on the internal data register after the scan is completed.

*3) The internal circuit and thermocouple input circuit are not insulated. Therefore, use the nongrounding type thermocouples and sheath tubes.

FP-e Series

Technical data

■ Transistor NPN output specifications (For Y0 to Y4)

Item	Description
Insulation method	Optical coupler
Output type	Open collector
Rated load voltage	5 to 24 V DC
Operating load voltage range	4.75 to 26.4 V DC
Max. load current	0.5 A
Max. surge current	1 A
Output points per common	5 points/common
OFF state leakage current	100 μ A or less
ON state voltage drop	1.5 V or less
Response time	OFF \rightarrow ON 1 ms or less (For Y0 and Y1), 1 ms or less (For Y2, Y3 and Y4)
	ON \rightarrow OFF 50 μ s or less (For Y0 and Y1), 1 ms or less (For Y2, Y3 and Y4)
External power supply (For driving internal circuit)	Voltage 21.6 to 26.4 V DC
	Current 6 mA/point (For Y0 and Y1) 3 mA/point (For Y2, Y3, and Y4)
Surge absorber	Zener diode
Operating indicator	LCD display (I/O monitor mode)

■ Relay output specifications (Y5)

Item	Description
Output type	Normally open (1 Form A)
Rated control capacity	2 A 250 V AC, 2 A 30 V DC
Output points per common	1 point/common
Response time	OFF \rightarrow ON Approx. 10 ms
	ON \rightarrow OFF Approx. 8 ms
Life time	Mechanical Min. 2×10^7 operations
	Electrical Min. 10^5 operations (resistive load)
Surge absorber	None
Operating indicator	LCD display (I/O monitor mode)

■ COM. port communication specifications *1)

Item	Description	
COM. port type	RS232C *2)	RS485
Isolation status with the internal circuit	Non-isolated	Isolated
Transmission distance	15 m	1200 m
Baud rate *3)	300, 600, 1200, 2400, 4800, 9600, 19200 bit/s	9600, 19200 bit/s *4)
Communication method	Half-duplex	
Synchro system	Synchronous communication method	
Transmission format	Stop bit: 1 bit/2 bit	
	Parity: Not available/Available (Odd number/Even number)	
	Data length: 7 bit/8 bit	
	Beginning code: STX available/STX not available	
Data output order	Starting from 0 bit per character	
	Ending code: CR/CR+LF/not available/ETX	
No. of connected units	—	99 *5) *6)
Communication mode	• General-purpose communication	• General-purpose communication
	• Computer link	• Computer link

- *1) When communicating between FP-e and other device, it is recommended to perform resend processing.
- *2) For RS232C wiring, be sure to use shield wires for higher noise immunity.
- *3) Set the baud rate of RS485 to both FP-e system register and FP-e internal switch. Set the baud rate of RS232C to FP-e system register.
- *4) When sending a command from the FP-e is completed in RS485 communication, send a response from the receive device to the FP-e after the following time has been elapsed: 9600 bit/s: 2 ms or longer 19200 bit/s: 1 ms or longer
It takes at least 1 scan time (at least 2 ms) for the FP-e to send back a response after receiving the command.
- *5) When our C-NET Adapter or other RS485 device than recommended is connected in the system, the maximum connection number is limited to 32 units.
- *6) For a RS485 converter on the computer side, SI-35 (from LINE EYE Co., Ltd.) is recommended.
When SI-35 is used in the system, up to 99 units can be connected.

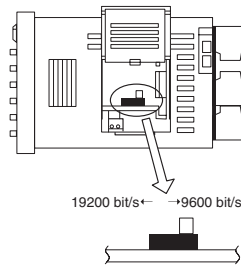

■ Dimensions

(mm)

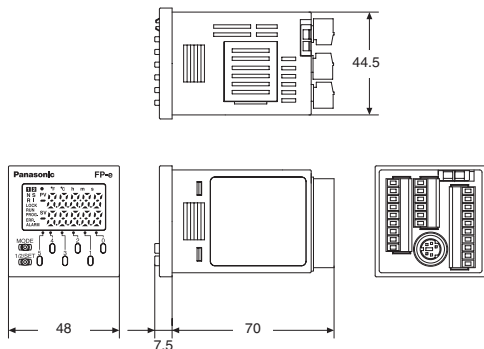

■ Wiring diagram

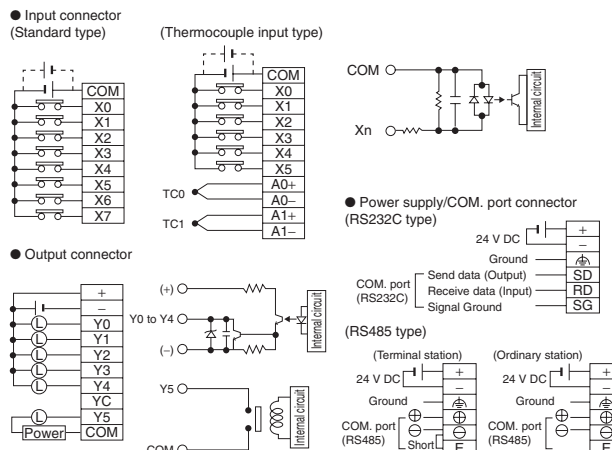

FP-e Options

Options

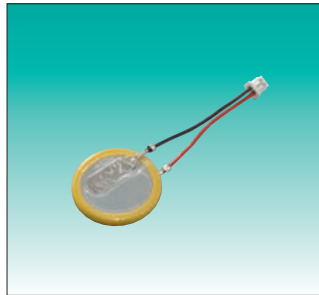

Backup battery

Included with calendar timer type

Part No.: **AFPG804**

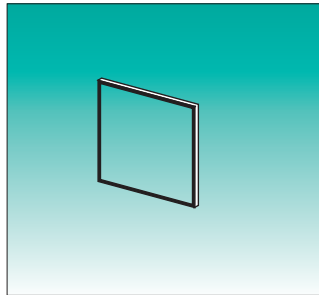

Rubber gasket

Included with unit

Part No.: **ATC18002**

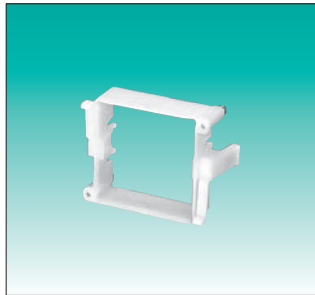

Mounting frame

Included with unit

Part No.: **AT8-DA4**



Panel cover

Color: Black

Part No.: **AFPE803** (20 sets)

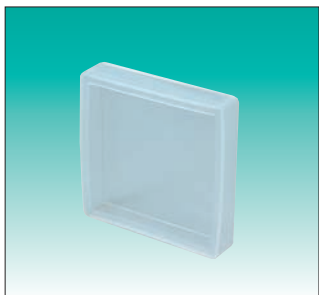

Protective cover

Part No.: **AQM4803**

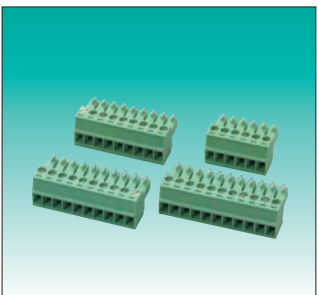

Terminal socket set

4 type sockets, additional part

Part No.: **AFPE804**

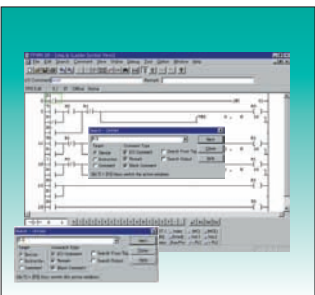

Programming tool software

Programming tool software

Control FPWIN Pro

Part No.: FPWINPROSEN5

(Small version, English manual)

FPWINPROSFR5

(Small version, French manual)

FPWINPROSDE5

(Small version, German manual)

FPWINPROFEN5

(Full version, English manual)

FPWINPROFFR5

(Full version, French manual)

FPWINPROFDE5

(Full version, German manual)

Control FPWIN GR

Part No.: FPWINGRF2 (Full version)

Programming cable

Part No.: **AFC8513**

Panasonic Electric Works

Please contact our Global Sales Companies in:

Europe

▶ Headquarters	Panasonic Electric Works Europe AG	Rudolf-Diesel-Ring 2, 83607 Holzkirchen, Tel. (08024) 648-0, Fax (08024) 648-111, www.panasonic-electric-works.com
▶ Austria	Panasonic Electric Works Austria GmbH PEW Electronic Materials Europe GmbH	Rep. of PEWDE, Josef Madersperger Str. 2, 2362 Biedermannsdorf, Tel. (02236) 26846, Fax (02236) 46133, www.panasonic-electric-works.at Ennshafenstraße 9, 4470 Enns, Tel. (07223) 883, Fax (07223) 88333, www.panasonic-electronic-materials.com
▶ Benelux	Panasonic Electric Works Sales Western Europe B.V.	De Rijn 4, (Postbus 211), 5684 PJ Best, (5680 AE Best), Netherlands, Tel. (0499) 372727, Fax (0499) 372185, www.panasonic-electric-works.nl
▶ Czech Republic	Panasonic Electric Works Czech s.r.o.	Průmyslová 1, 34815 Planá, Tel. 374 799 990, Fax 374 799 999, www.panasonic-electric-works.cz
▶ France	Panasonic Electric Works Sales Western Europe B.V.	French Branch Office, B.P. 44, 91371 Verrières le Buisson CEDEX, Tél. 01 60135757, Fax 01 60135758, www.panasonic-electric-works.fr
▶ Germany	Panasonic Electric Works Deutschland GmbH	Rudolf-Diesel-Ring 2, 83607 Holzkirchen, Tel. (08024) 648-0, Fax (08024) 648-555, www.panasonic-electric-works.de
▶ Hungary	Panasonic Electric Works Europe AG	Magyarországi Közvetlen Kereskedelmi Képviselet, 1117 Budapest, Neumann János u. 1., Tel. 06 1 482 9258, Fax 06 1 482 9259, www.panasonic-electric-works.hu
▶ Ireland	Panasonic Electric Works UK Ltd.	Dublin, Tel. (01) 4600969, Fax (01) 4601131, www.panasonic-electric-works.co.uk
▶ Italy	Panasonic Electric Works Italia s.r.l. PEW Building Materials Europe s.r.l.	Via del Commercio 3-5 (Z.I. Ferlina), 37012 Bussolengo (VR), Tel. (045) 6752711, Fax (045) 6700444, www.panasonic-electric-works.it Piazza della Repubblica 24, 20154 Milano (MI), Tel. (02) 29005391, Fax (02) 29003466, www.panasonic-building-materials.com
▶ Nordic Countries	Panasonic Electric Works Nordic AB PEW Fire & Security Technology Europe AB	Sjöängsvägen 10, 19272 Sollentuna, Sweden, Tel. (08) 59476680, Fax (08) 59476690, www.panasonic-electric-works.se Citadellsvägen 23, 21118 Malmö, Tel. (040) 6977000, Fax (040) 6977099, www.panasonic-fire-security.com
▶ Poland	Panasonic Electric Works Europe AG	Przedstawicielstwo w Polsce, Al. Krakowska 4/6, 02-284 Warszawa, Tel. 22 338-11-33, Fax 22 338-12-00, www.panasonic-electric-works.pl
▶ Portugal	Panasonic Electric Works España S.A.	Portuguese Branch Office, Avda Adelino Amaro da Costa 728 R/C J, 2750-277 Cascais, Tel. (21) 4812520, Fax (21) 4812529
▶ Spain	Panasonic Electric Works España S.A.	Barajas Park, San Severo 20, 28042 Madrid, Tel. (91) 3293875, Fax (91) 3292976, www.panasonic-electric-works.es
▶ Switzerland	Panasonic Electric Works Schweiz AG	Grundstrasse 8, 6343 Rotkreuz, Tel. (041) 7997050, Fax (041) 7997055, www.panasonic-electric-works.ch
▶ United Kingdom	Panasonic Electric Works UK Ltd.	Sunrise Parkway, Linford Wood, Milton Keynes, MK14 6LF, Tel. (01908) 231555, Fax (01908) 231599, www.panasonic-electric-works.co.uk

North & South America

▶ USA	PEW Corporation of America	629 Central Avenue, New Providence, N.J. 07974, Tel. 1-908-464-3550, Fax 1-908-464-8513, www.pewa.panasonic.com
--------------	-----------------------------------	---

Asia Pacific/China/Japan

▶ China	Panasonic Electric Works (China) Co., Ltd.	Level 2, Tower W3, The Towers Oriental Plaza, No. 2, East Chang An Ave., Dong Cheng District, Beijing 100738, Tel. (010) 8518-5988, Fax (010) 8518-1297
▶ Hong Kong	Panasonic Electric Works (Hong Kong) Co., Ltd.	RM1205-9, 12/F, Tower 2, The Gateway, 25 Canton Road, Tsimshatsui, Kowloon, Hong Kong, Tel. (0852) 2956-3118, Fax (0852) 2956-0398
▶ Japan	Matsushita Electric Works, Ltd.	1048 Kadoma, Kadoma-shi, Osaka 571-8686, Japan, Tel. (06) 6908-1050, Fax (06) 6908-5781, www.mew.co.jp/e-acg/
▶ Singapore	Panasonic Electric Works Asia Pacific Pte. Ltd.	101 Thomson Road, #25-03/05, United Square, Singapore 307591, Tel. (06255) 5473, Fax (06253) 5689

Panasonic®