

All-4-One™ International Transformers

Chassis Mount with Lead Wires



International Standards at Lower Cost and Better Performance



Designed to provide the high isolation, creepage and clearance necessary to comply with international safety standards.

General Specifications

- Power - 25 VA to 175 VA
- Dielectric Strength - 4000 VRMS Hipot
- Primaries - Dual primaries (115/230 V - 50/60 Hz)
- Dual Secondaries - Series or parallel
- Leakage - Current meets UL 60601-1, IEC/EN 60601-2
- Insulation - Class F (155° C)
- Flammability Rating - Bobbin and shroud material meet UL 94-V0

Agency Certifications

- UL 1446 E66312
- Recognized to UL 506 / UL 5085-2, CSA 22.2, No. 66-1 / 5085 File # E63829
- VDE certified to VDE 0805 / EN 60950, Reg-Nr-1448



Part Number	VA Size	Secondary RMS Rating		Lead Wire Gauge Secondary
		Series	Parallel	
A41-25-10L	25	10.0 VCT @ 2.5A	5.0V @ 5.0A	18AWG
A41-43-10L	43	10.0 VCT @ 4.3A	5.0V @ 8.6A	18AWG
A41-80-10L	80	10.0 VCT @ 8.0A	5.0V @ 16.0A	18AWG
A41-130-10L	130	10.0 VCT @ 13.0A	5.0V @ 26.0A	16AWG
A41-175-10L	175	10.0 VCT @ 17.5A	5.0V @ 35.0A	16AWG
A41-25-12L	25	12.6 VCT @ 2.0A	6.3V @ 4.0A	18AWG
A41-43-12L	43	12.6 VCT @ 3.4A	6.3V @ 6.8A	18AWG
A41-80-12L	80	12.6 VCT @ 6.3A	6.3V @ 12.6A	18AWG
A41-130-12L	130	12.6 VCT @ 10.3A	6.3V @ 20.6A	16AWG
A41-175-12L	175	12.6 VCT @ 14.0A	6.3V @ 28.0A	16AWG
A41-25-16L	25	16.0 VCT @ 1.6A	8.0V @ 3.2A	18AWG
A41-43-16L	43	16.0 VCT @ 2.7A	8.0V @ 5.4A	18AWG
A41-80-16L	80	16.0 VCT @ 5.0A	8.0V @ 10.0A	18AWG
A41-130-16L	130	16.0 VCT @ 8.1A	8.0V @ 16.2A	16AWG
A41-175-16L	175	16.0 VCT @ 11.0A	8.0V @ 22.0A	16AWG
A41-25-20L	25	20.0 VCT @ 1.25A	10 V @ 2.5A	18AWG
A41-43-20L	43	20.0 VCT @ 2.2A	10 V @ 4.4A	18AWG
A41-80-20L	80	20.0 VCT @ 4.0A	10 V @ 8.0A	18AWG
A41-130-20L	130	20.0 VCT @ 6.5A	10 V @ 13.0A	16AWG
A41-175-20L	175	20.0 VCT @ 8.8A	10 V @ 17.6A	16AWG
A41-25-24L	25	24.0 VCT @ 1.0A	12 V @ 2.0A	18AWG
A41-43-24L	43	24.0 VCT @ 1.8A	12 V @ 3.6A	18AWG
A41-80-24L	80	24.0 VCT @ 3.3A	12 V @ 6.6A	18AWG
A41-130-24L	130	24.0 VCT @ 5.4A	12 V @ 10.8A	18AWG
A41-175-24L	175	24.0 VCT @ 7.3A	12 V @ 14.6A	18AWG
A41-25-28L	25	28.0 VCT @ 0.9A	14 V @ 1.8A	18AWG
A41-43-28L	43	28.0 VCT @ 1.5A	14 V @ 3.0A	18AWG
A41-80-28L	80	28.0 VCT @ 2.8A	14 V @ 5.6A	18AWG
A41-130-28L	130	28.0 VCT @ 4.6A	14 V @ 9.2A	18AWG
A41-175-28L	175	28.0 VCT @ 6.25A	14 V @ 12.5A	18AWG
A41-25-36L	25	36.0 VCT @ 0.7A	18 V @ 1.4A	18AWG
A41-43-36L	43	36.0 VCT @ 1.2A	18 V @ 2.4A	18AWG
A41-80-36L	80	36.0 VCT @ 2.2A	18 V @ 4.4A	18AWG
A41-130-36L	130	36.0 VCT @ 3.6A	18 V @ 7.2A	18AWG
A41-175-36L	175	36.0 VCT @ 4.8A	18 V @ 9.6A	18AWG
A41-25-230L	25	230 VCT @ 0.11A	115V @ 0.22A	18AWG
A41-43-230L	43	230 VCT @ 0.19A	115V @ 0.38A	18AWG
A41-80-230L	80	230 VCT @ 0.35A	115V @ 0.7A	18AWG
A41-130-230L	130	230 VCT @ 0.57A	115V @ 1.14A	18AWG
A41-175-230L	175	230 VCT @ 0.76A	115V @ 1.52A	18AWG

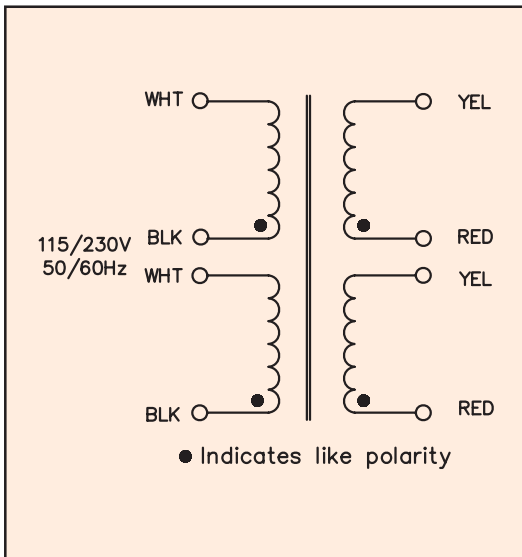

Lead Wires

- Hook up lead wire style UL1015, CSA TEW
- Rated 600V -40° to +105° C
- Passes UL VW-1 (flame test)
- All primary lead wires are 18AWG UL 1015
- All lead wires are 12" in length

Custom versions available upon request.

©2008 Signal Transformer — Specification subject to change without notice. 07.08



500 Bayview Avenue, Inwood, NY 11096
 Toll Free 866-239-5777 • Tel 516-239-5777 • Fax 516-239-7208
 sales@signaltransformer.com • techhelp@signaltransformer.com

All-4-One™ International Transformers

Chassis Mount with Lead Wires

International Standards at Lower Cost and Better Performance

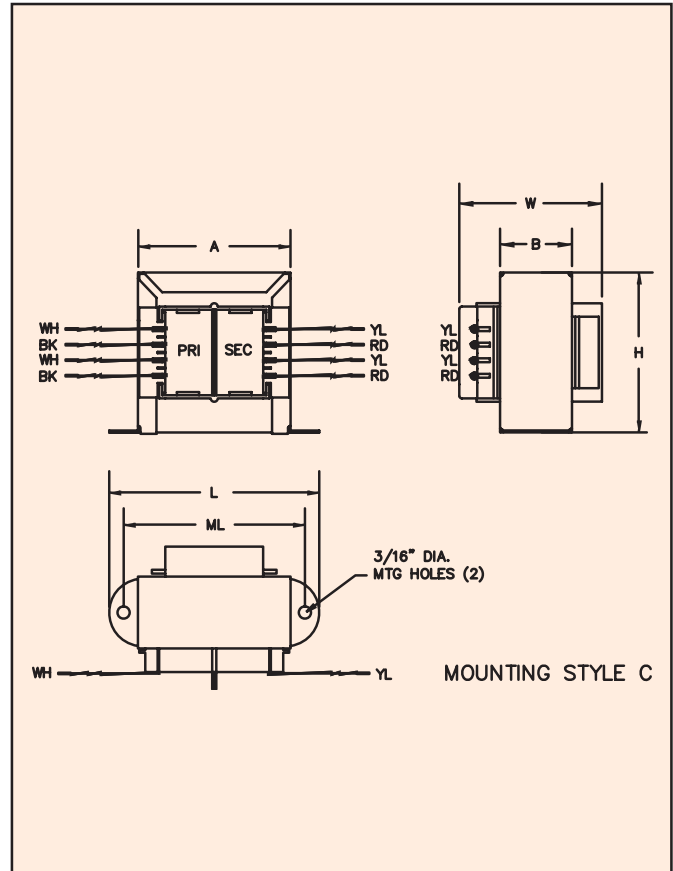
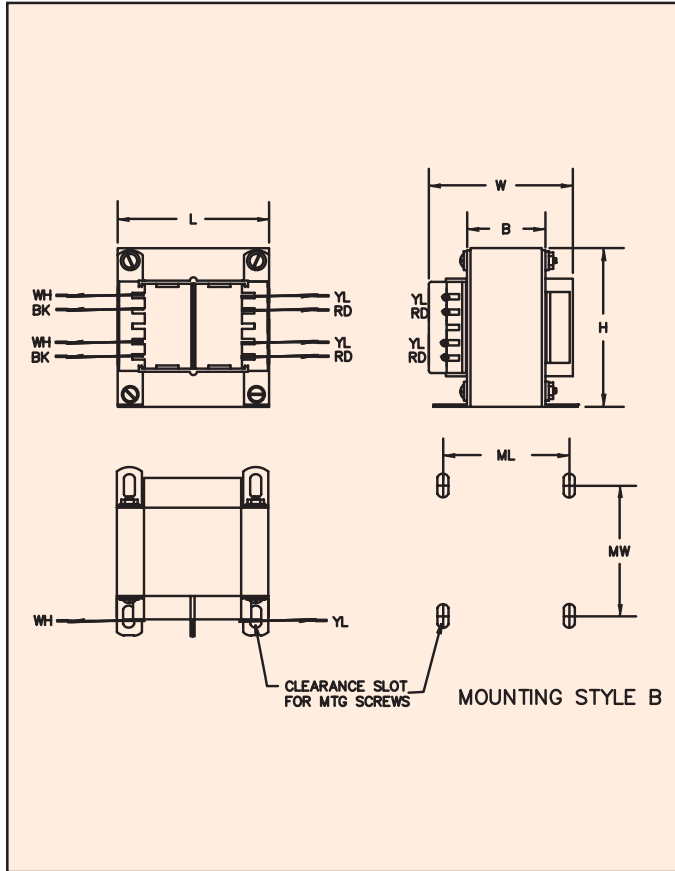

VA	Dimensions					Lead Wire Length Inches (mm) Standard	Mounting Style	Mounting Dimensions		Mounting Screw	Weight lbs (kg)
	L	W	H	A	B			ML	MW		
Size	Inches (mm)										
25	2.81 (71.4)	2.14 (54.4)	2.31 (58.7)	2.00 (50.8)	1.12 (28.6)	12.0 (304.80)	C	2.37 (60.3)	-	#6	1.25 lbs (0.57)
43	3.12 (79.4)	2.14 (54.4)	2.68 (68.2)	2.25 (57.2)	1.12 (28.6)	12.0 (304.80)	C	2.81 (71.4)	-	#6	1.6 lbs (0.73)
80	2.50 (63.5)	2.52 (64.3)	3.00 (76.2)	-	1.37 (35.0)	12.0 (304.80)	B	2.00 (50.8)	2.18 (55.5)	#6	2.8 lbs (1.27)
130	2.81 (71.4)	3.00 (76.2)	3.37 (85.7)	-	1.62 (41.3)	12.0 (304.80)	B	2.25 (57.2)	2.50 (63.5)	#8	4.1 lbs (1.86)
175	3.12 (79.4)	3.14 (79.7)	3.75 (95.3)	-	1.62 (41.3)	12.0 (304.80)	B	2.50 (63.5)	2.50 (63.5)	#8	5.5 lbs (2.49)

Custom versions available upon request.

©2008 Signal Transformer — Specification subject to change without notice. 07.08



500 Bayview Avenue, Inwood, NY 11096
 Toll Free 866-239-5777 • Tel 516-239-5777 • Fax 516-239-7208
 sales@signaltransformer.com • techhelp@signaltransformer.com