



EVERLIGHT ELECTRONICS CO.,LTD.

# DATA SHEET

PART NO. : A253B/SYG/S530-E2

DATE : 2004/8/20

DEPARTMENT : CHR&D1

REVISION : 1

<b>RECEIVED</b>			
<input checked="" type="checkbox"/> MASS PRODUCTION			
<input type="checkbox"/> PRELIMINARY			
<input type="checkbox"/> CUSTOMER DESIGN			
DEVICE NUMBER : CDAE-025-035			
PAGE : 6			
CUSTOMER	DESIGNER	CHECKER	APPROVER

REV.	DESCRIPTION	RELEASE DATE

OFFICE: 7C BUILDING, LIAN HUA PORT INDUSTRIAL DISTRICT, LIAN HUA SHAN  
BONDED PRICESSING ZONE PAN YU, GUANG ZHU, CHINA

TEL. : (020)84860913,84860914

FAX : (020)84860600

<http://www.everlight.com>



# EVERLIGHT ELECTRONICS CO.,LTD.

## Technical Data Sheet

### 5.0mm Round Type LED Lamps

#### A253B/SYG/S530-E2

#### ■ Features :

- Low power consumption
- High efficiency and low cost
- Good control and free combinations on the colors of LED lamps
- Good lock and easy to assembly
- Stackable and easy to assembly
- Stackable vertically and easy to assembly
- Versatile mounting on P.C board or panel
- Stackable horizontally and easy to assembly
- Pb free



#### ■ Descriptions :

- ARRAY=Plastic Holder+Combinations of Lamps
- The array will easily mount the applicable lamps on any panel up to

#### ■ Applications :

- 1.Used as indicators of indicating the Degree, Functions, Positions etc, in electronic instruments.

PART NO.	Chip		Lens Color
	Material	Emitted Color	
333-2SYGD/S530-E2	AlGaInP	Super Yellow Green	Green Diffused

Emitted Color	Lens Color
---------------	------------

Technical Data Sheet

5.0mm Round Type LED Lamps

**A253B/SYG/S530-E2**

**Package Dimensions**

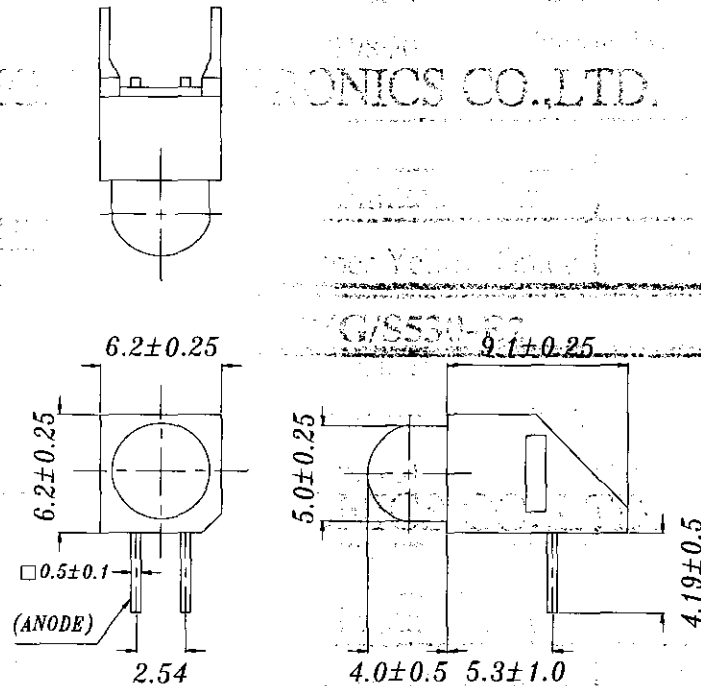

- Notes:**
- 1.All dimensions are in millimeters, tolerance is 0.25mm except being specified
  - 2.Lead spacing is measured where the lead emerge from the package

**Absolute Maximum Ratings at Ta = 25°C**

Parameter	Symbol	Rating	Unit
Forward Current	IF	25	mA
Operating Temperature	Topr	-40 to +85	°C
Storage Temperature	Tstg	-40 to +100	°C
Soldering Temperature	Tsol	260 ± 5	°C
Electrostatic Discharge	ESD	2000	V
Power Dissipation	Pd	60	mW
Peak Forward Current	IF(Peak)	160	mA
Reverse Voltage	VR	5	V

- Note: \*1:IFP Conditions --Pulse Width ≤ 1msec and Duty ≤ 1/10.  
 \*2:Soldering time ≤ 5 seconds.



# EVERLIGHT ELECTRONICS CO.,LTD.

## Technical Data Sheet

### 5.0mm Round Type LED Lamps

#### A253B/SYG/S530-E2

#### Electro-Optical Characteristics (Ta=25°C)

Parameter	Symbol	Condition	Min.	Typ.	Max.	Unit
Forward Voltage	V <sub>F</sub>	I <sub>F</sub> = 20 mA	/	2.0	2.4	V
Reverse Current	I <sub>R</sub>	V <sub>R</sub> = 5 V	/	/	10	μA
Luminous Intensity	I <sub>v</sub>	I <sub>F</sub> = 20 mA	40	80	/	mcd
Viewing Angle	2θ 1/2	I <sub>F</sub> = 20 mA	/	45	/	deg
Peak Wavelength	λ <sub>p</sub>	I <sub>F</sub> = 20 mA	/	575	/	nm
Dominant Wavelength	λ <sub>d</sub>	I <sub>F</sub> = 20 mA	/	573	/	nm
Spectrum Radiation Bandwidth	Δλ	I <sub>F</sub> = 20 mA	/	20	/	nm



Technical Data Sheet

5.0mm Round Type LED Lamps

A253B/SYG/S530-E2

Typical Electro-Optical Characteristic Curves:

(SYG) Spectrum Distribution

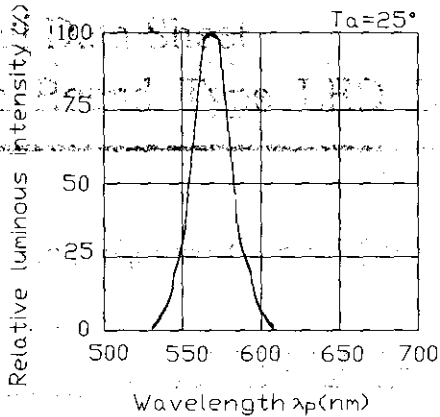

Forward Current vs. Forward Voltage

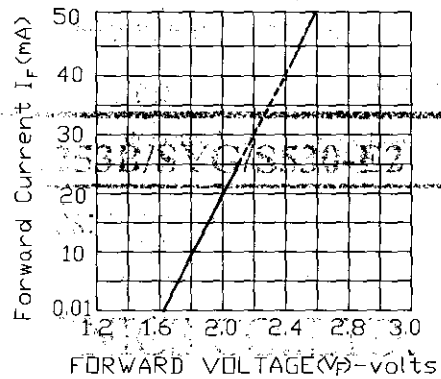

Relative Luminous Intensity vs. Ambient Temperature. ( $I_f=20\text{mA}$ )

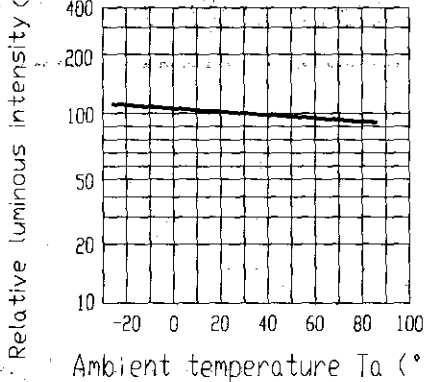

Luminous Intensity vs. Forward Current  $T_a=25^\circ$

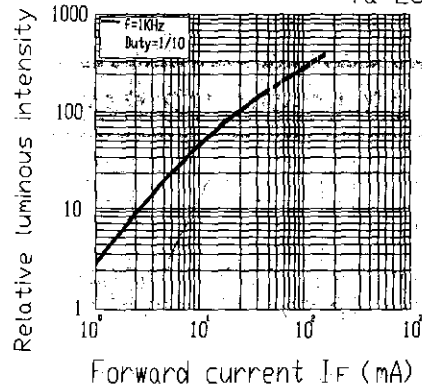

Forward Current Derating Curve  $T_a=25^\circ$

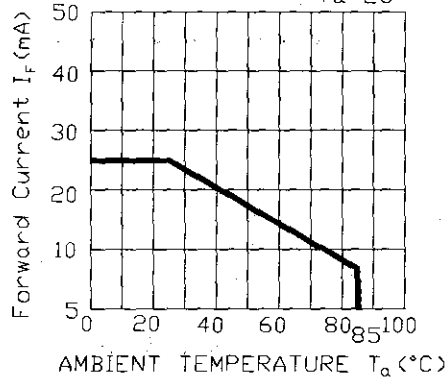

Radiation Diagram  $T_a=25^\circ\text{C}$

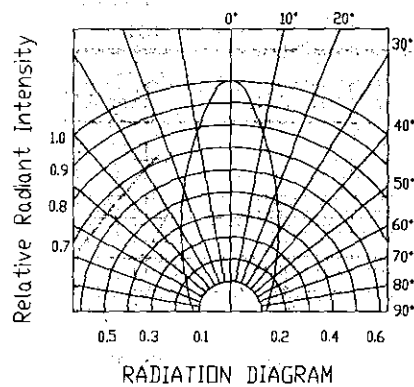



# EVERLIGHT ELECTRONICS CO.,LTD.

## Technical Data Sheet

### 5.0mm Round Type LED Lamps

#### A253B/SYG/S530-E2

#### ■ Reliability test items and conditions:

NO	Item	Test Conditions	Test Hours/Cycle	Sample Size	Ac/Re
1	Solder Heat	TEMP : 260°C ± 5 °C	10 SEC	76 PCS	0/1
2	Temperature Cycle	H : +100°C 15min ∫ 5 min L : -40°C 15min	300 CYCLES	76 PCS	0/1
3	Thermal Shock	H : +100°C 5min ∫ 10 sec L : -10°C 5min	300 CYCLES	76 PCS	0/1
4	High Temperature Storage	TEMP : 100°C	1000 HRS	76 PCS	0/1
5	Low Temperature Storage	TEMP : -40°C	1000 HRS	76 PCS	0/1
6	DC Operating Life	TEMP : 25°C If = 20mA	1000 HRS	76 PCS	0/1
7	High Temperature / High Humidity	85°C / 85% RH	1000 HRS	76 PCS	0/1



# EVERLIGHT ELECTRONICS CO.,LTD.

## Technical Data Sheet

### 5.0mm Round Type LED Lamps

#### A253B/SYG/S530-E2

#### Packing Quantity Specification

- 1. 250PCS/1Bag : 5Bags/1Box
- 2. 10Boxes/1Carton

#### Label Form Specification



CPN:  
P/N:



A253B/SYG/S530-E2

QTY:



CAT:  
HUE:  
REF:

LOT NO: EL



MADE IN TAIWAN

CPN: Customer's Production Number

P/N : Production Number

QTY: Packing Quantity

CAT: Ranks

HUE: Peak Wavelength

REF: Reference

LOT No: Lot Number

MADE IN TAIWAN: Production Place

#### Notes

1. Above specification may be changed without notice. EVERLIGHT will reserve authority on material change for above specification.
2. When using this product, please observe the absolute maximum ratings and the instructions for using outlined in these specification sheets. EVERLIGHT assumes no responsibility for any damage resulting from use of the product which does not comply with the absolute maximum ratings and the instructions included in these specification sheets.
3. These specification sheets include materials protected under copyright of EVERLIGHT corporation.

Please don't reproduce or cause anyone to reproduce them without EVERLIGHT's consent.

EVERLIGHT ELECTRONICS CO., LTD.	Tel: (886-2-2267-2000, 2267-9936
Office: No 25, Lane 76, Sec 3, Chung Yang Rd,	Fax: 886-2267-6244, 2267-6189, 2267-6306
Tucheng, Taipei 236, Taiwan, R.O.C	http://www.everlight.com

2267-9936  
2267-6189, 2267-6306

# Mouser Electronics

Authorized Distributor

Click to View Pricing, Inventory, Delivery & Lifecycle Information:

[Everlight:](#)

[A253B/SYG/S530-E2](#)