

Socket

Header

Compliance with RoHS Directive

## FEATURES

**1. Ultra-small 0.35-mm pitch contributes to downsizing of equipment.**

Socket compared to P4S already on the market: 11%

Header: Space-saving of 12%  
(Comparison using a 20-pin connector)

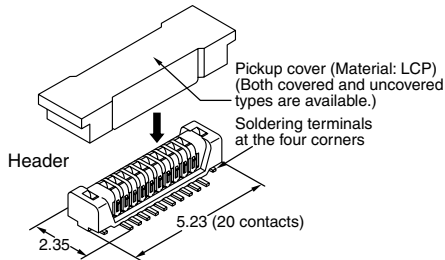
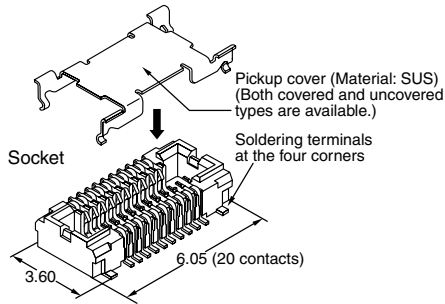

**2. Strong resistance to adverse environments! Utilizes "TOUGH CONTACT" construction for high contact reliability.**

(See Page 6 for details of the structure)

Note: If extra resistance to drop impact is required, we recommend using our P4 series.

**3. Greater flexibility in connector placement.**

Pattern wiring to the connector bottom is possible because the undersurface of the connector is constructed with a molded covering.

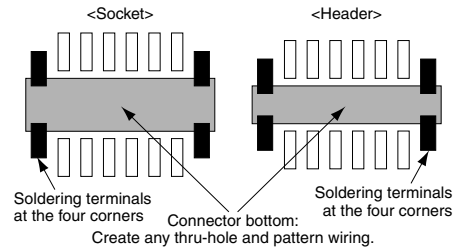

**4. Automatic mounting inspection is facilitated by the gull-wing terminal shape which makes mounting verification easy.**

**5. Connectors for inspection available**  
Connectors are available that are ideal for inspection in module unit inspection and device assembly processes.

## APPLICATIONS

Compact portable devices "Cellular phones, DVC, Digital cameras, etc"

Ideal for Board-to-FPC connections

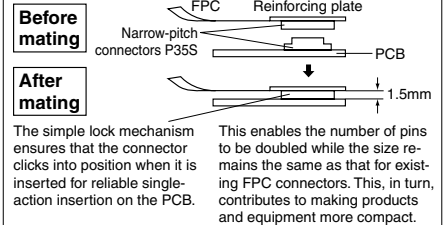

## ORDERING INFORMATION

AXT    1  4

1: Narrow Pitch Connector P35S (0.35 mm pitch) Socket  
2: Narrow Pitch Connector P35S (0.35 mm pitch) Header

Number of contacts (2 digits)

Mated height

<Socket>/<Header>

1: For mated height 1.5 mm

Functions

<Socket>/<Header>

2: No pickup cover, without positioning bosses

6: With pickup cover, without positioning bosses

Surface treatment (Contact portion / Terminal portion)

<Socket>

4: Ni plating on base, Au plating on surface (for Ni barrier available)

<Header>

4: Ni plating on base, Au plating on surface

**PRODUCT TYPES** 

| Mated height | Number of contacts | Part number |           | Packing      |              |
|--------------|--------------------|-------------|-----------|--------------|--------------|
|              |                    | Socket      | Header    | Inner carton | Outer carton |
| 1.5mm        | 20                 | AXT120124   | AXT220124 | 3,000 pieces | 6,000 pieces |
|              | 22                 | AXT122124   | AXT222124 |              |              |
|              | 24                 | AXT124124   | AXT224124 |              |              |
|              | 26                 | AXT126124   | AXT226124 |              |              |
|              | 28                 | AXT128124   | AXT228124 |              |              |
|              | 30                 | AXT130124   | AXT230124 |              |              |
|              | 32                 | AXT132124   | AXT232124 |              |              |
|              | 34                 | AXT134124   | AXT234124 |              |              |
|              | 36                 | AXT136124   | AXT236124 |              |              |
|              | 38                 | AXT138124   | AXT238124 |              |              |
|              | 40                 | AXT140124   | AXT240124 |              |              |
|              | 50                 | AXT150124   | AXT250124 |              |              |
|              | 52                 | AXT152124   | AXT252124 |              |              |
|              | 60                 | AXT160124   | AXT260124 |              |              |
|              | 70                 | AXT170124   | AXT270124 |              |              |
|              | 80                 | AXT180124   | AXT280124 |              |              |
| 90           | AXT190124          | AXT290124   |           |              |              |
| 100          | AXT100124          | AXT200124   |           |              |              |

- Notes: 1. Regarding ordering units; During production: Please make orders in 1-reel units.  
 Samples for mounting confirmation: Available in units of 50 pieces. Please consult us.  
 Samples: Small lot orders are possible. Please consult us.  
 2. If you require the pickup cover, change the eighth digit of the part number from "2" to "6" in your order. Note that the pickup cover is not available for some types depending on the number of contacts. Check the latest product specifications.  
 3. The above part numbers are for connectors without positioning bosses, which are standard. When ordering connectors with positioning bosses, please contact our sales office.  
 4. Connectors of different number of contacts are available on-demand production only. Please contact us for more details.

**SPECIFICATIONS**

**1. Characteristics**

| Item  |  | Specifications   | Conditions   |
|---|--|--|--|
| Electrical characteristics                            | Rated current  | 0.25A/contact (Max. 4 A at total contacts)   | —  |
|   | Rated voltage  | 60V AC/DC  | —  |
|   | Breakdown voltage                                    | 150V AC for 1 min.   | Rated voltage is applied for one minute and check for short circuit or damage with a detection current of 1mA. |
|   | Insulation resistance                                | Min. 1,000MΩ (initial)   | Using 250V DC megger (applied for 1 min.)  |
|   | Contact resistance                                   | Max. 100mΩ   | Based on the contact resistance measurement method specified by JIS C 5402.                                    |
| Environmental characteristics                         | Ambient temperature                                  | -55°C to +85°C   | No freezing at low temperatures  |
|   | Soldering heat resistance                            | Max. peak temperature of 260°C (on the surface of the PC board around the connector terminals) | Infrared reflow soldering  |
|   |  | 300°C within 5 sec. or 350°C within 3 sec.   | Soldering iron   |
|   | Storage temperature                                  | -55°C to +85°C (product only)<br>-40°C to +50°C (emboss packing)                               | No freezing at low temperatures  |
|   | Thermal shock resistance (header and socket mated)   | 5 cycles, insulation resistance min. 100MΩ, contact resistance max. 100mΩ                      | Sequence<br>1. -55.0°C, 30 minutes<br>2. ~, Max. 5 minutes<br>3. 85±0.5°C, 30 minutes<br>4. ~, Max. 5 minutes  |
|   | Humidity resistance (header and socket mated)        | 120 hours, insulation resistance min. 100MΩ, contact resistance max. 100mΩ                     | Temperature 40±2°C, humidity 90 to 95% R.H.  |
|   | Saltwater spray resistance (header and socket mated) | 24 hours, insulation resistance min. 100MΩ, contact resistance max. 100mΩ                      | Temperature 35±2°C, saltwater concentration 5±1%   |
| H <sub>2</sub> S resistance (header and socket mated) | 48 hours, contact resistance max. 100mΩ              | Temperature 40±2°C, gas concentration 3±1 ppm, humidity 75 to 80% R.H.                         |  |
| Lifetime characteristics                              | Insertion and removal life                           | 50 times   | Repeated insertion and removal speed of max. 200 times/hours   |

**2. Material and surface treatment**

| Part name        | Material            | Surface treatment  |
|------------------|---------------------|--|
| Molded portion   | LCP resin (UL94V-0) | —  |
| Contact and Post | Copper alloy        | Contact portion: Ni plating on base, Au plating on surface<br>Terminal portion: Ni plating on base, Au plating on surface (Except for front edge of terminal)<br>However, the area adjacent to the socket terminal is exposed to Ni on base.<br>Soldering terminal portion;<br>Socket: Ni plating on base, Pd + Au flash plating on surface (Expect for front edge of terminal)<br>Header: Ni plating on base, Au plating on surface (Expect for front edge of terminal) |

# AXT1, 2

## DIMENSIONS (Unit: mm)

The CAD data of the products with a **CAD Data** mark can be downloaded from: <http://panasonic-electric-works.net/ac>

### 1. Socket (Mated height: 1.5mm)

- Without pickup cover

#### CAD Data

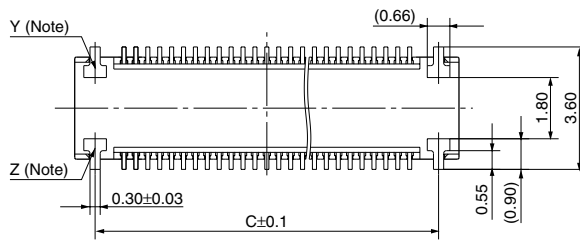
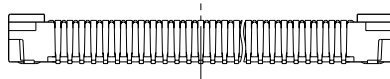
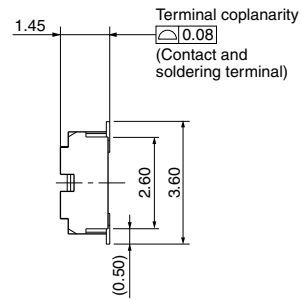
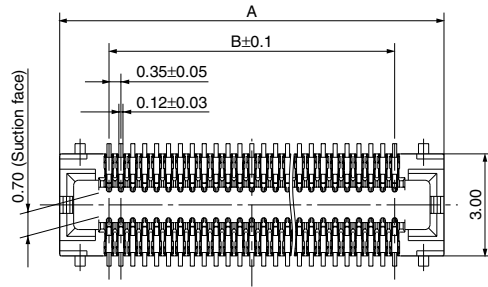

General tolerance:  $\pm 0.2$

Dimension table (mm)

| Number of contacts/<br>dimension | A     | B     | C     |
|----------------------------------|-------|-------|-------|
| 20                               | 6.05  | 3.15  | 4.85  |
| 22                               | 6.40  | 3.50  | 5.20  |
| 24                               | 6.75  | 3.85  | 5.55  |
| 26                               | 7.10  | 4.20  | 5.90  |
| 28                               | 7.45  | 4.55  | 6.25  |
| 30                               | 7.80  | 4.90  | 6.60  |
| 32                               | 8.15  | 5.25  | 6.95  |
| 34                               | 8.50  | 5.60  | 7.30  |
| 36                               | 8.85  | 5.95  | 7.65  |
| 38                               | 9.20  | 6.30  | 8.00  |
| 40                               | 9.55  | 6.65  | 8.35  |
| 50                               | 11.30 | 8.40  | 10.10 |
| 52                               | 11.65 | 8.75  | 10.45 |
| 60                               | 13.05 | 10.15 | 11.85 |
| 70                               | 14.80 | 11.90 | 13.60 |
| 80                               | 16.55 | 13.65 | 15.35 |
| 90                               | 18.30 | 15.40 | 17.10 |
| 100                              | 20.05 | 17.15 | 18.85 |

- With pickup cover

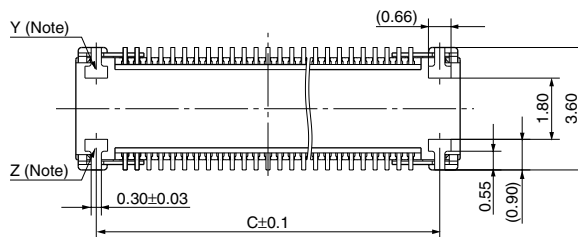
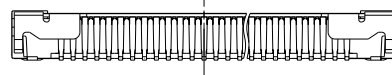
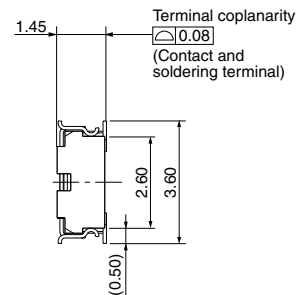
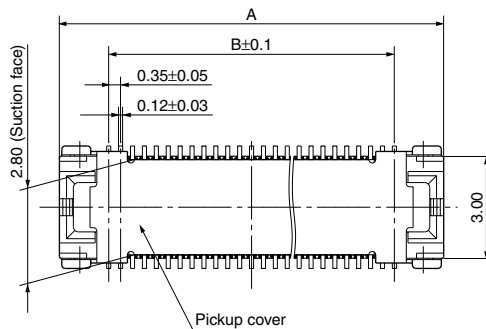

General tolerance:  $\pm 0.2$

Note: Since soldering terminals are built into the body, the Y and Z parts are connected electrically.

## 2. Header (Mated height: 1.5mm)

- Without pickup cover

### CAD Data

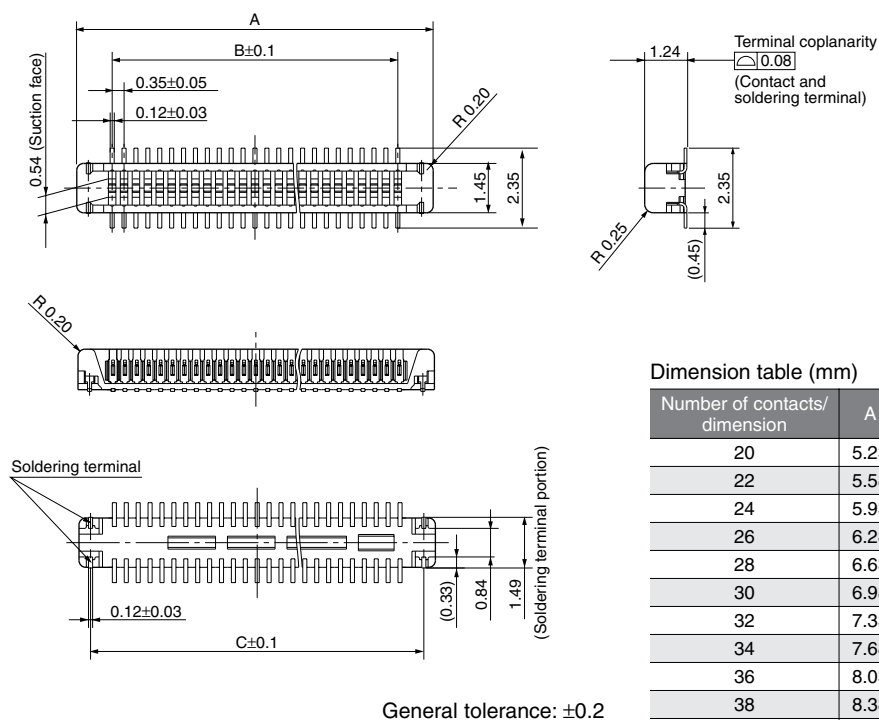

Dimension table (mm)

| Number of contacts/<br>dimension | A     | B     | C     | C     |
|----------------------------------|-------|-------|-------|-------|
| 20                               | 5.23  | 3.15  | 4.55  | 6.73  |
| 22                               | 5.58  | 3.50  | 4.90  | 7.08  |
| 24                               | 5.93  | 3.85  | 5.25  | 7.43  |
| 26                               | 6.28  | 4.20  | 5.60  | 7.78  |
| 28                               | 6.63  | 4.55  | 5.95  | 8.13  |
| 30                               | 6.98  | 4.90  | 6.30  | 8.48  |
| 32                               | 7.33  | 5.25  | 6.65  | 8.83  |
| 34                               | 7.68  | 5.60  | 7.00  | 9.18  |
| 36                               | 8.03  | 5.95  | 7.35  | 9.53  |
| 38                               | 8.38  | 6.30  | 7.70  | 9.88  |
| 40                               | 8.73  | 6.65  | 8.05  | 10.23 |
| 50                               | 10.48 | 8.40  | 9.80  | 11.98 |
| 52                               | 10.83 | 8.75  | 10.15 | —     |
| 60                               | 12.23 | 10.15 | 11.55 | 13.73 |
| 70                               | 13.98 | 11.90 | 13.30 | 15.48 |
| 80                               | 15.73 | 13.65 | 15.05 | 17.23 |
| 90                               | 17.48 | 15.40 | 16.80 | 19.98 |
| 100                              | 19.23 | 17.15 | 18.55 | 20.73 |

- With pickup cover

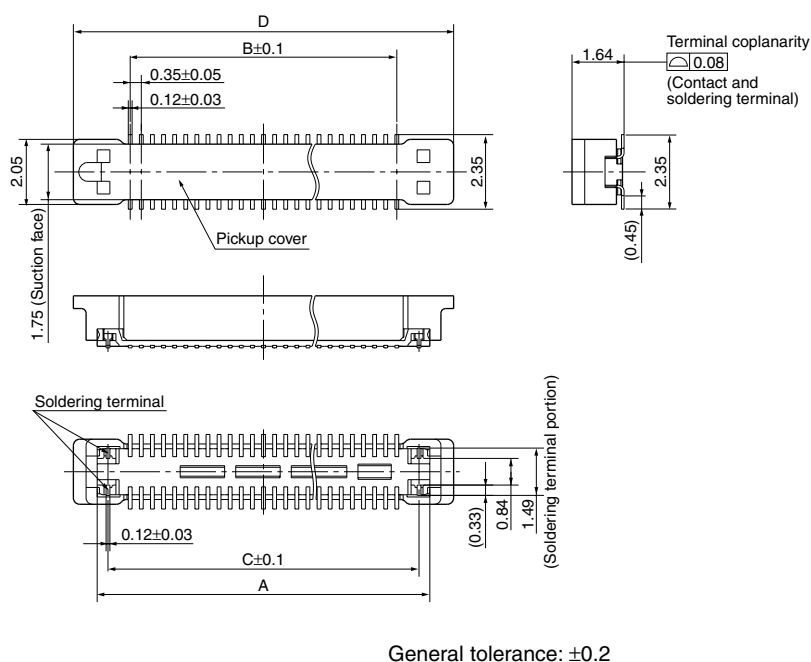

# AXT1, 2

Socket and Header are mated

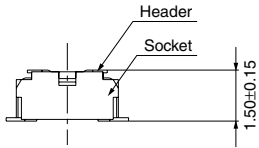

## EMBOSSED TAPE DIMENSIONS (unit: mm, Common for respective contact type, socket and header)

• Tape dimensions (Conforming to JIS C 0806-1990.

• Plastic reel dimensions (Conforming to EIAJ ET-7200B)

However, some tapes have mounting hole pitches that do not comply with the standard.)

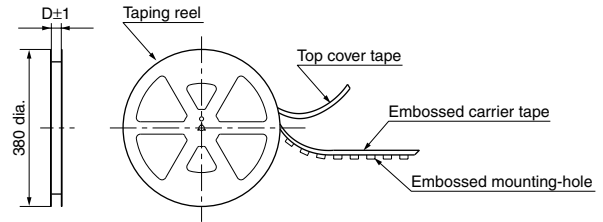
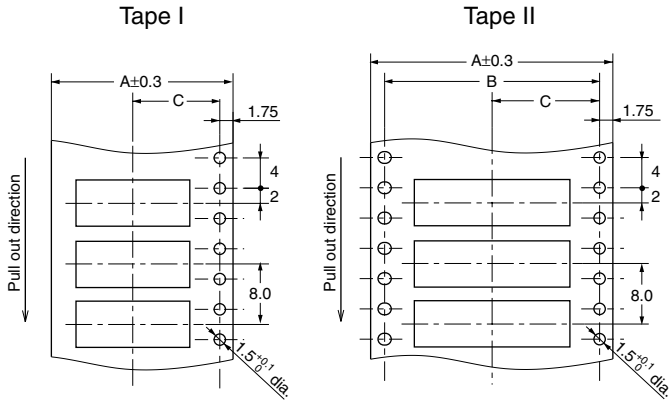

### Dimension table (mm)

| Mated height                           | Number of contacts | Type of taping | A    | B    | C    | D    | Quantity per reel |
|--|--------------------|----------------|------|------|------|------|-------------------|
| Common for socket and header:<br>1.5mm | Max. 24            | Tape I         | 16.0 | —    | 7.5  | 17.4 | 3,000             |
|  | 26 to 70           | Tape I         | 24.0 | —    | 11.5 | 25.4 | 3,000             |
|  | 72 to 100          | Tape II        | 32.0 | 28.4 | 14.2 | 33.4 | 3,000             |

### Connector orientation with respect to direction of progress of embossed tape

| Direction of tape progress<br>↓ | Type   | Common for P35S |  |
|---------------------------------|--------|-----------------|--|
|                                 | Socket | Header          |  |
|                                 |        |                 |  |

Note: There is no indication on this product regarding top-bottom or left-right orientation.

**CONNECTOR FOR INSPECTION  
USAGE APPLICATIONS WITH  
3,000 INSERTION AND  
REMOVAL TIMES**

**NARROW PITCH CONNECTOR P35S  
(0.35 mm PITCHES) FOR INSPECTION USAGE**

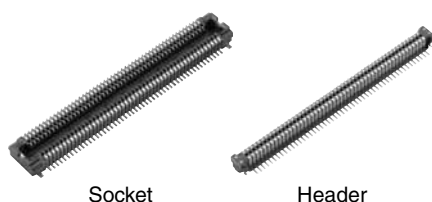

**Compliance with RoHS Directive**

## FEATURES

### 1. 3,000 insertion and removals (when as recommended)

From the 50 insertion and removals of standard type, up to 3,000 insertion and removals (with recommended insertion and removal) are possible for use in inspection.

Ideal for inspection of module units and inspection during the device assembly process

### 2. Same external dimensions and foot pattern as mated height 1.5mm standard type.

Since shape is the same as mated height 1.5mm standard type, inspection is possible without interfering with devices in the vicinity of standard connectors.

### 3. Improved mating

Insertion and removal have become easier due to a reduction in the mating retention force required by the simple locking structure and also in the amount of force needed for insertion and removal. (We cannot warrant anything regarding mating retention.)

## TABLE OF PRODUCT TYPES

☆: Available for sale

| Product name | P35S for inspection |
|--------------|---------------------|
| 20           | ☆                   |
| 22           | ☆                   |
| 24           | ☆                   |
| 26           | ☆                   |
| 28           | ☆                   |
| 30           | ☆                   |
| 32           | ☆                   |
| 34           | ☆                   |
| 36           | ☆                   |
| 38           | ☆                   |
| 40           | ☆                   |
| 50           | ☆                   |
| 52           | ☆                   |
| 60           | ☆                   |
| 70           | ☆                   |
| 80           | ☆                   |
| 90           | ☆                   |
| 100          | ☆                   |

Notes:

1. The pickup surface shape of the inspection sockets is different from that of the standard sockets. (For details, refer to the product specification diagram.)
2. Please inquire numbers of contacts other than those listed above.
3. Please inquire us regarding delivery times.
4. Please keep ordering unit no less than 50 pieces per lot.
5. Please inquire for further information.

## PRODUCT TYPES

| Specifications |                   |                            | Part No.  | Specifications |                   |                            | Part No.  |
|----------------|-------------------|----------------------------|-----------|----------------|-------------------|----------------------------|-----------|
| Socket         | With pickup cover | Without positioning bosses | AXT1E**66 | Header         | With pickup cover | Without positioning bosses | AXT2E**66 |
|                | No pickup cover   | Without positioning bosses | AXT1E**26 |                | No pickup cover   | Without positioning bosses | AXT2E**26 |

- Notes: 1. When placing an order, substitute the "\*" (asterisk) in the above part number with the number of contacts for the required connector.  
 2. The above part numbers are for connectors without positioning bosses, which are standard. When ordering connectors with positioning bosses, please contact our sales office.

# AXT1, 2

## NOTES

1. As shown below, excess force during insertion may result in damage to the connector or removal of the solder. Please be careful. Also, to prevent connector damage please confirm the correct position before mating connectors.

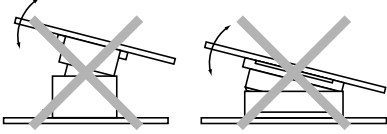

2. Keep the PC board warp no more than 0.03 mm in relation to the overall length of the connector

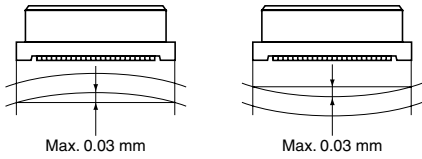

3. If extra resistance to shock caused by dropping is required, we recommend using our previous P4 Series.

### 4. PC Boards and Recommended Metal Mask Patterns

Connectors are mounted with high density, with a pitch interval of 0.35 mm, 0.4 mm or 0.5 mm.

In order to reduce solder bridge and other issues make sure the proper levels of solder are used.

The figures to the right are recommended metal mask patterns. Please use them as a reference.

### Socket (Mated height: 1.5mm)

Recommended PC board pattern  
(TOP VIEW)

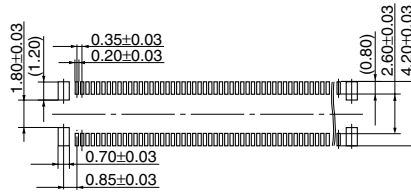

### Recommended metal mask pattern

Metal mask thickness: Here, 120 μm  
(Terminal portion opening area ratio: 60%)  
(Metal portion opening area ratio: 100%)

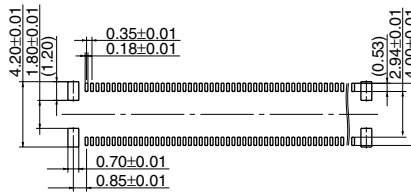

### Header (Mated height: 1.5mm)

Recommended PC board pattern  
(TOP VIEW)

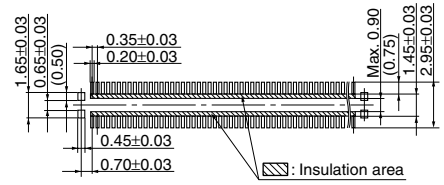

### Recommended metal mask pattern

Metal mask thickness: Here, 120 μm  
(Terminal portion opening area ratio: 60%)  
(Metal portion opening area ratio: 100%)

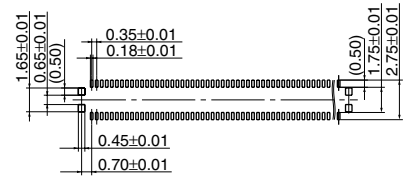

For other details, please verify with the product specification sheets.

# Mouser Electronics

Authorized Distributor

Click to View Pricing, Inventory, Delivery & Lifecycle Information:

## Panasonic:

[AXT100114](#) [AXT100124](#) [AXT100154](#) [AXT100164](#) [AXT120114](#) [AXT120124](#) [AXT120154](#) [AXT120164](#) [AXT122114](#)  
[AXT122124](#) [AXT122154](#) [AXT122164](#) [AXT124114](#) [AXT124124](#) [AXT124154](#) [AXT124164](#) [AXT126114](#) [AXT126124](#)  
[AXT126154](#) [AXT126164](#) [AXT130114](#) [AXT130124](#) [AXT130154](#) [AXT130164](#) [AXT132114](#) [AXT132124](#) [AXT132154](#)  
[AXT132164](#) [AXT134114](#) [AXT134124](#) [AXT134154](#) [AXT134164](#) [AXT136114](#) [AXT136124](#) [AXT136154](#) [AXT136164](#)  
[AXT138114](#) [AXT138124](#) [AXT138154](#) [AXT138164](#) [AXT140114](#) [AXT140124](#) [AXT140154](#) [AXT140164](#) [AXT150114](#)  
[AXT150124](#) [AXT150154](#) [AXT150164](#) [AXT152114](#) [AXT152124](#) [AXT152154](#) [AXT152164](#) [AXT160114](#) [AXT160124](#)  
[AXT160154](#) [AXT160164](#) [AXT170114](#) [AXT170124](#) [AXT170154](#) [AXT170164](#) [AXT180114](#) [AXT180124](#) [AXT180154](#)  
[AXT180164](#) [AXT190114](#) [AXT190124](#) [AXT190154](#) [AXT190164](#) [AXT200114](#) [AXT200124](#) [AXT200154](#) [AXT200164](#)  
[AXT220114](#) [AXT220124](#) [AXT220154](#) [AXT220164](#) [AXT222114](#) [AXT222124](#) [AXT222154](#) [AXT222164](#) [AXT224114](#)  
[AXT224124](#) [AXT224154](#) [AXT224164](#) [AXT226114](#) [AXT226124](#) [AXT226154](#) [AXT226164](#) [AXT230114](#) [AXT230124](#)  
[AXT230154](#) [AXT230164](#) [AXT232114](#) [AXT232124](#) [AXT232154](#) [AXT232164](#) [AXT234114](#) [AXT234124](#) [AXT234154](#)  
[AXT234164](#)