

ACPL-M21L, ACPL-021L, ACPL-024L, ACPL-W21L and ACPL-K24L

Low Power, 5 MBd Digital CMOS Optocoupler



Data Sheet



Lead (Pb) Free
RoHS 6 fully
compliant

RoHS 6 fully compliant options available;
-xxxE denotes a lead-free product

Description

ACPL-M21L (single channel SO-5 package), ACPL-021L (single channel SO-8 package), ACPL-024L (dual channel SO-8 package), ACPL-W21L (single channel stretched SO-6 package) and ACPL-K24L (dual channel stretched SO-8 package) are optically-coupled logic gates. The detector IC has CMOS output stage and optical receiver input stage with built-in Schmitt trigger to provide logic-compatible waveforms, eliminating the need for additional wave-shaping.

An internal shield on the ACPL-M21L/021L/024L/W21L/K24L guarantees common mode transient immunity of 25 kV/ μ s at a common mode voltage of 1000V. The ACPL-x2xL optocouplers' series operates from a 2.7 V to 5.5 V supply with guaranteed AC and DC performance from an extended temperature range of -40 °C to 105 °C. Glitches free output upon power-up and power-down of optocoupler.

Functional Diagram

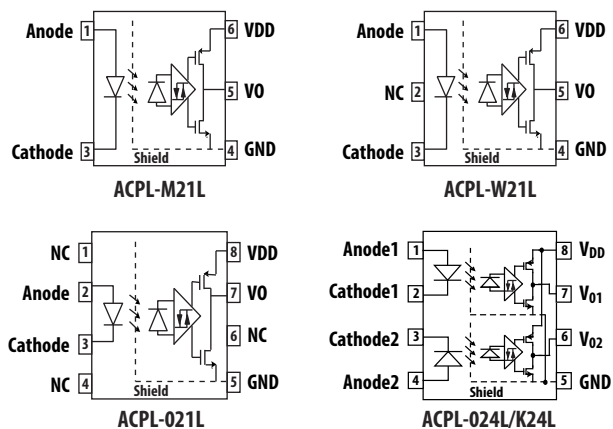

TRUTH TABLE (POSITIVE LOGIC)

LED	VO
ON	HIGH
OFF	LOW

A 0.1 μ F bypass capacitor must be connected between pins Vdd and GND

Features

- CMOS output
- Wide supply voltage: 2.7 V – 5.5 V
- Low power supply current I_{DD} : 1.1 mA/channel max.
- Low forward current I_F : 1.6 mA min
- Speed: 5 MBd typ
- Pulse width distortion (PWD): 200 ns max
- Propagation delay skew (tpsk): 220 ns max
- Propagation delay (tp): 250 ns max
- Common mode rejection: 25 kV/ μ s min at $V_{CM} = 1000$ V
- Hysteresis: 0.2 mA typ
- Temperature range: -40 °C to 105 °C
- Safety and regulatory approvals
 - UL 1577 recognized – 3750 Vrms for 1 minute for ACPL-M21L/021L/024L and 5000 Vrms for 1 minute for ACPL-W21L/K24L
 - CSA Approval
 - IEC/EN 60747-5-5, Approval for Reinforced Insulation

Applications

- Low isolation of high speed logic systems
- Computer peripheral interface
- Microprocessor system interface
- Ground loop elimination
- Pulse transformer replacement
- High speed line receiver
- Power control systems

Ordering Information

ACPL-M21L, ACPL-024L and ACPL-021L are UL Recognized with 3750 V_{rms} for 1 minute per UL1577.

ACPL-W21L and ACPL-K24L are UL Recognized with 5000 V_{rms} for 1 minute per UL1577.

Part number	Option		Surface Mount	Tape & Reel	UL1577	IEC/EN 60747-5-5	Quantity
	RoHS Compliant	Package			5000 V _{rms} / 1 Minute Rating		
ACPL-M21L	-000E	SO-5	X				100 per tube
	-060E		X			X	100 per tube
	-500E		X	X			1500 per reel
	-560E		X	X		X	1500 per reel
ACPL-024L	-000E	SO-8	X				100 per tube
	-060E		X			X	100 per tube
	-500E		X	X			1500 per reel
	-560E		X	X		X	1500 per reel
ACPL-021L	-000E	SO-8	X				100 per tube
	-060E		X			X	100 per tube
	-500E		X	X			1500 per reel
	-560E		X	X		X	1500 per reel
ACPL-W21L	-000E	Stretched SO6	X		X		100 per tube
	-060E		X		X	X	100 per tube
	-500E		X	X	X		1000 per reel
	-560E		X	X	X	X	1000 per reel
ACPL-K24L	-000E	Stretched SO8	X		X		80 per tube
	-060E		X		X	X	80 per tube
	-500E		X	X	X		1000 per reel
	-560E		X	X	X	X	1000 per reel

To order, choose a part number from the part number column and combine with the desired option from the option column to form an order entry.

Example 1:

ACPL-M21L-500E to order product of SO-5 package in Tape and Reel packaging with RoHS compliant.

Option datasheets are available. Contact your Avago sales representative or authorized distributor for information.

Package Outline Drawings

ACPL-M21L S0-5 Package

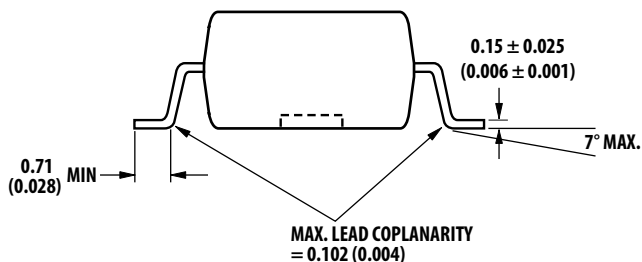
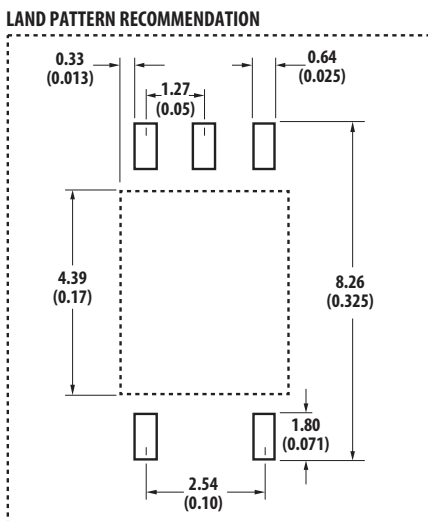
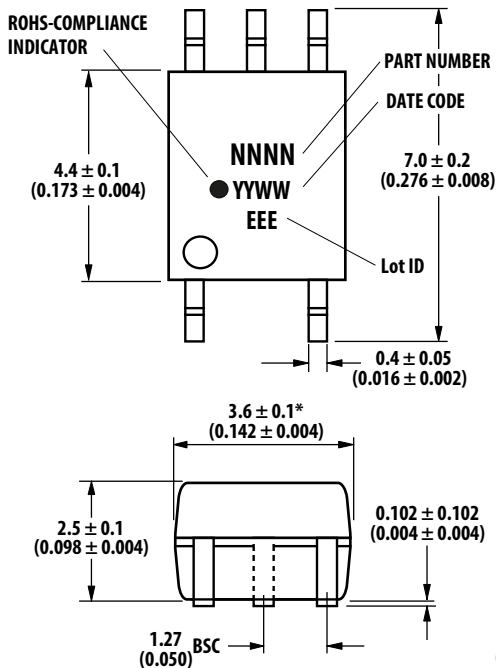

Dimensions in millimeters (inches).
 Note: Floating Lead Protrusion is 0.15 mm (6 mils) max.

* Maximum Mold flash on each side is 0.15 mm (0.006).

ACPL-024L/021L S0-8 Package

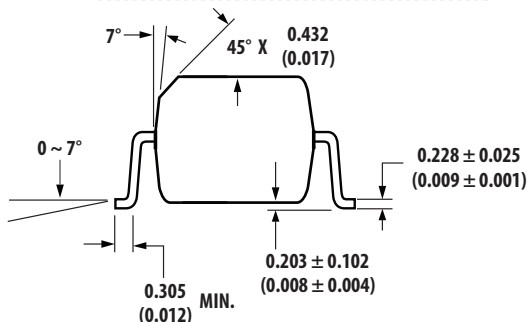
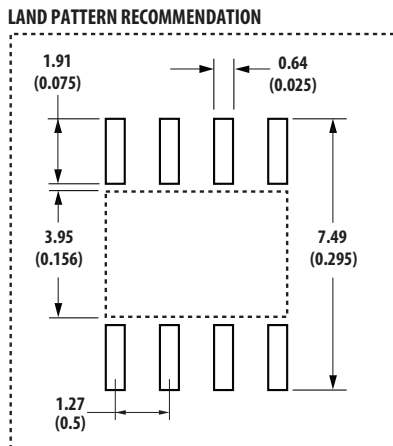
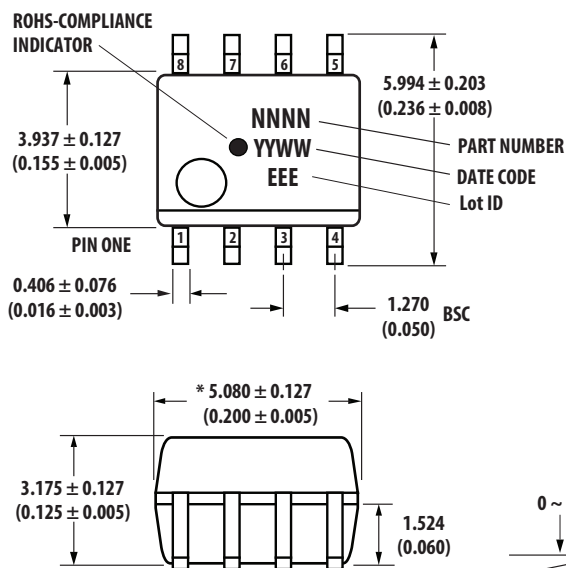

* Total package length (inclusive of mold flash)
 5.207 ± 0.254 (0.205 ± 0.010)

Dimensions in Millimeters (Inches).
 Note: Floating lead protrusion is 0.15 mm (6 mils) max.
 Lead coplanarity = 0.10 mm (0.004 inches) max.
 Option number 500 not marked.

ACPL-W21L Stretched SO-6 Package

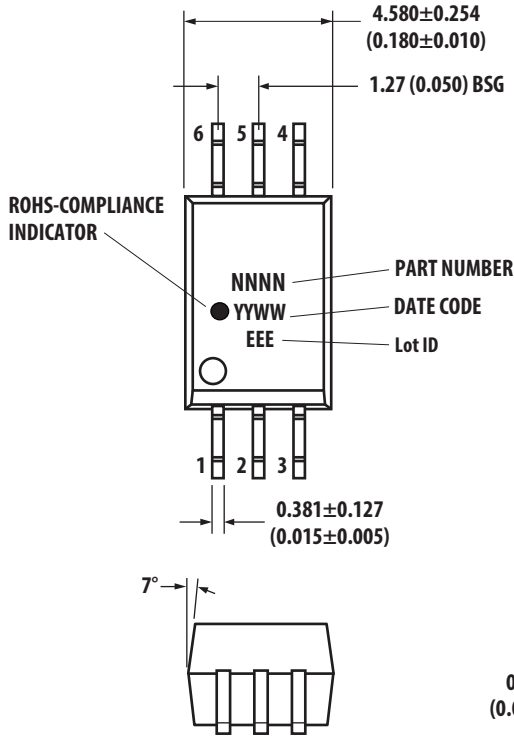

Dimensions in Millimeters (Inches).
Lead coplanarity = 0.1 mm (0.004 inches).

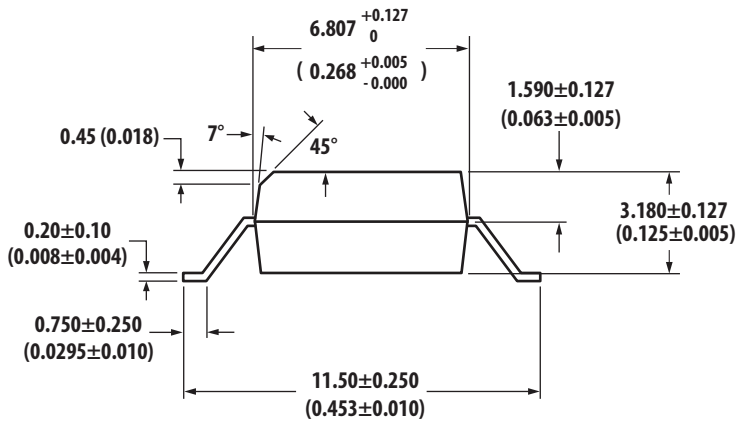
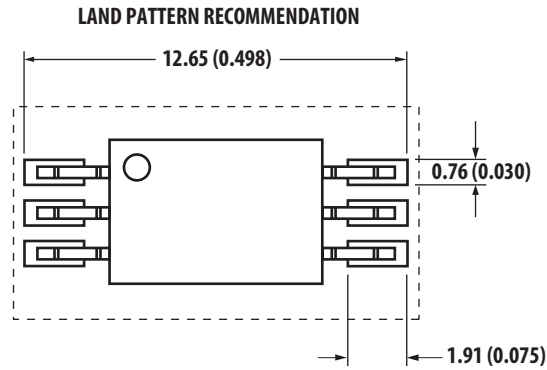

ACPL-K24L Stretched SO-8 Package

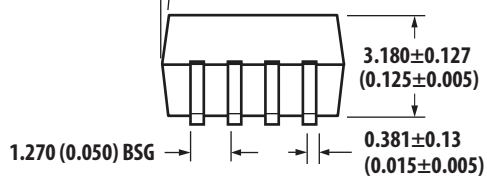
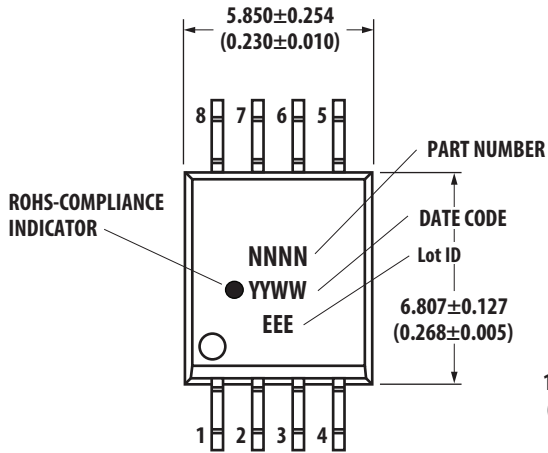

Dimensions in Millimeters (Inches).
Lead coplanarity = 0.1 mm (0.004 inches).

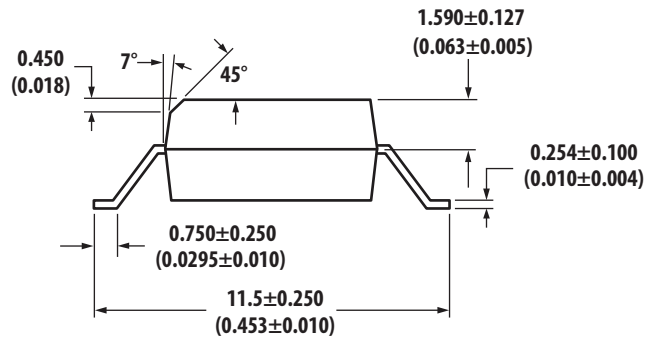
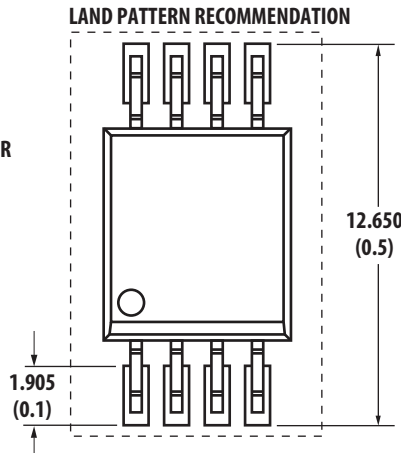

Solder Reflow Profile

Recommended reflow condition as per JEDEC Standard, J-STD-020 (latest revision). Non-Halide Flux should be used.

Regulatory Information

The ACPL-M21L/024L/021L/W21L/K24L is approved by the following organizations:

UL	Approval under UL 1577, component recognition program up to $V_{ISO} = 3750 V_{RMS}$ for ACPL-M21L/024L/021L and $V_{ISO} = 5000 V_{RMS}$ for ACPL-W21L/K24L
CSA	Approval under CSA Component Acceptance Notice #5.
IEC/EN 60747-5-5	(Option 060 and 560 only)

Insulation and Safety Related Specifications

Parameter	Symbol	ACPL-024L ACPL-W21L			Units	Conditions
		ACPL-M21L	/021L	/K24L		
Minimum External Air Gap (Clearance)	L(101)	5	4.9	8	mm	Measured from input terminals to output terminals, shortest distance through air.
Minimum External Tracking (Creepage)	L(102)	5	4.8	8	mm	Measured from input terminals to output terminals, shortest distance path along body.
Minimum Internal Plastic Gap (Internal Clearance)		0.08	0.08	0.08	mm	Through insulation distance conductor to conductor, usually the straight line distance thickness between the emitter and detector.
Tracking Resistance (Comparative Tracking Index)	CTI	175	175	175	Volts	DIN IEC 112/VDE 0303 Part 1
Isolation Group		IIIa	IIIa	IIIa		Material Group (DIN VDE 0110, 1/89, Table 1)

IEC/EN 60747-5-5 Insulation Characteristics* (Option 060 and 560 only)

Description	Symbol	Characteristic		Unit
		ACPL-M21L/ 024L/021L	ACPL-W21L/ K24L	
Installation classification per DIN VDE 0110/39, Table 1 for rated mains voltage $\leq 150 V_{rms}$ for rated mains voltage $\leq 300 V_{rms}$ for rated mains voltage $\leq 600 V_{rms}$ for rated mains voltage $\leq 1000 V_{rms}$		I – IV I – III I – II	I – IV I – IV I – III I – III	
Climatic Classification		55/105/21	55/105/21	
Pollution Degree (DIN VDE 0110/39)		2	2	
Maximum Working Insulation Voltage	V_{IORM}	567	1140	V_{peak}
Input to Output Test Voltage, Method b* $V_{IORM} \times 1.875 = V_{PR}$, 100% Production Test with $t_m = 1$ sec, Partial discharge < 5 pC	V_{PR}	1063	2137	V_{peak}
Input to Output Test Voltage, Method a* $V_{IORM} \times 1.6 = V_{PR}$, Type and Sample Test, $t_m = 10$ sec, Partial discharge < 5 pC	V_{PR}	896	1824	V_{peak}
Highest Allowable Overvoltage (Transient Overvoltage $t_{ini} = 60$ sec)	V_{IOTM}	6000	8000	V_{peak}
Safety-limiting values – maximum values allowed in the event of a failure.				
Case Temperature	T_S	150	175	$^{\circ}C$
Input Current**	$I_S, INPUT$	150	230	mA
Output Power**	$P_S, OUTPUT$	600	600	mW
Insulation Resistance at $T_S, V_{IO} = 500$ V	R_S	$>10^9$	$>10^9$	Ω

* Refer to the optocoupler section of the Isolation and Control Components Designer's Catalog, under Product Safety Regulations section, (IEC/EN 60747-5-5) for a detailed description of Method a and Method b partial discharge test profiles.

** Refer to the following figure for dependence of P_S and I_S on ambient temperature.

Absolute Maximum Ratings

Parameter	Symbol	Min	Max	Units	Condition
Storage Temperature	T_S	-55	125	$^{\circ}C$	
Operating Temperature	T_A	-40	105	$^{\circ}C$	
Reverse Input Voltage	V_R		5	V	
Supply Voltage	V_{DD}		6.5	V	
Average Forward Input Current	I_F		8	mA	
Peak Forward Input Current	$I_{F(TRAN)}$		1	A	$\leq 1 \mu s$ Pulse Width, < 300 pulses per second
Output Current	I_O		10	mA	At max V_{DD}
Output Voltage	V_O	-0.5	$V_{DD} + 0.5$	V	
Lead Solder Temperature	T_{LS}		260 $^{\circ}C$ for 10 sec., 1.6 mm below seating plane		
Solder Reflow Temperature Profile		See Package Outline Drawings section			

Recommended Operating Conditions

Parameter	Symbol	Min	Max	Units
Operating Temperature	T_A	-40	105	°C
Input Current, Low Level	I_{FL}	0	250	μA
Input Current, High Level	I_{FH}	1.6*	6	mA
Power Supply Voltage	V_{DD}	2.7	5.5	V
Forward Input Voltage	$V_{F(OFF)}$		0.8	V

* The initial switching threshold is 1.6 mA or less. It is recommended that 2.2 mA be used to permit at least a 20% LED degradation guardband.

Electrical Specifications (DC)

Over recommended temperature ($T_A = -40\text{ }^{\circ}\text{C}$ to $105\text{ }^{\circ}\text{C}$) and supply voltage ($2.7\text{ V} \leq V_{DD} \leq 5.5\text{ V}$). All typical specifications are at $V_{DD} = 2.7\text{ V}$, $T_A = 25\text{ }^{\circ}\text{C}$, unless otherwise specified.

Parameter	Symbol	Channel	Min	Typ	Max	Units	Test Conditions
Input Forward Voltage	V_F			1.5	2.0	V	$I_F = 2.2\text{ mA}$ (Figure 1 & 2)
Input Reverse Breakdown Voltage	BV_R		8	11		V	$I_R = 10\text{ }\mu A$
Logic High Output Voltage	V_{OH}		$V_{DD} - 0.1$			V	$I_F = 2.2\text{ mA}$, $I_O = -20\text{ }\mu A$
			$V_{DD} - 1.0$			V	$I_F = 2.2\text{ mA}$, $I_O = -3.2\text{ mA}$ (Figure 3)
Logic Low Output Voltage	V_{OL}			0.001	0.1	V	$I_F = 0\text{ mA}$, $I_O = 20\text{ }\mu A$
					0.15	0.4	V
Input Threshold Current	I_{TH}			0.5	1.4	mA	Figure 5
Logic Low Output Supply Current	I_{DDL}	Single		0.6	1.1	mA	$V_F = 0\text{ V}$, $V_{DD} = 5.5\text{ V}$, $I_O = \text{Open}$ (Figure 6)
		Dual		1.2	2.2		
Logic High Output Supply Current	I_{DDH}	Single		0.5	1.1	mA	$I_F = 2.2\text{ mA}$, $V_{DD} = 5.5\text{ V}$, $I_O = \text{Open}$ (Figure 7)
		Dual		1.0	2.2		
Input Capacitance	C_{IN}			77		pF	$f = 1\text{ MHz}$, $V_F = 0\text{ V}$
Input Diode Temperature Coefficient	$\Delta V_F / \Delta T_A$			-1.9		mV/°C	$I_F = 2.2\text{ mA}$

Switching Specifications (AC)

Over recommended temperature ($T_A = -40^\circ\text{C}$ to $+105^\circ\text{C}$), supply voltage ($2.7\text{ V} \leq V_{DD} \leq 5.5\text{ V}$). All typical specifications are at $V_{DD} = 2.7\text{ V}$, $T_A = 25^\circ\text{C}$

Parameter	Symbol	Min	Typ	Max	Units	Test Conditions
Propagation Delay Time to Logic Low Output ^[1]	t_{PHL}		130	250	ns	$I_F = 2.2\text{ mA}$, $C_L = 15\text{ pF}$ (Figure 8, 12) CMOS Signal Levels
Propagation Delay Time to Logic High Output ^[1]	t_{PLH}		115	250	ns	$I_F = 2.2\text{ mA}$, $C_L = 15\text{ pF}$ (Figure 9, 12) CMOS Signal Levels
Pulse Width Distortion ^[2]	PWD			200	ns	CMOS Signal Levels
Propagation Delay Skew ^[3]	t_{PSK}			220	ns	
Output Rise Time (10% – 90%)	t_R		11		ns	$I_F = 2.2\text{ mA}$, $C_L = 15\text{ pF}$, CMOS Signal Levels.
Output Fall Time (90% – 10%)	t_F		11		ns	$I_F = 2.2\text{ mA}$, $C_L = 15\text{ pF}$, CMOS Signal Levels.
Static Common Mode Transient Immunity at Logic High Output ^[4]	$ CM_H $	25	40		kV/ μs	$V_{CM} = 1000\text{ V}$, $T_A = 25^\circ\text{C}$, $I_F = 2.2\text{ mA}$, $C_L = 15\text{ pF}$, $V_I = 5\text{ V}$ ($R_T = 1.6\text{ k}\Omega$) or $V_I = 3.3\text{ V}$ ($R_T = 840\ \Omega$) CMOS Signal Levels Figure 13
Static Common Mode Transient Immunity at Logic Low Output ^[5]	$ CM_L $	25	40		kV/ μs	$V_{CM} = 1000\text{ V}$, $T_A = 25^\circ\text{C}$, $I_F = 0\text{ mA}$, $C_L = 15\text{ pF}$, $V_I = 0\text{ V}$ ($R_T = 1.6\text{ k}\Omega$) or ($R_T = 840\ \Omega$) CMOS Signal Levels Figure 13

Notes:

- t_{PHL} propagation delay is measured from the 50% (V_{in} or I_F) on the falling edge of the input pulse to the 50% V_{DD} of the falling edge of the V_O signal. t_{PLH} propagation delay is measured from the 50% (V_{in} or I_F) on the rising edge of the input pulse to the 50% level of the rising edge of the V_O signal
- PWD is defined as $|t_{PHL} - t_{PLH}|$
- t_{PSK} is equal to the magnitude of the worst case difference in t_{PHL} and/or t_{PLH} that will be seen between units at any given temperature within the recommended operating conditions.
- CM_H is the maximum tolerable rate of rise of the common mode voltage to assure that the output will remain in a high logic state.
- CM_L is the maximum tolerable rate of rise of the common mode voltage to assure that the output will remain in a low logic state.
- Use of a $0.1\ \mu\text{F}$ bypass capacitor connected between V_{DD} and ground is recommended.

Package Characteristics

All typical at $T_A = 25^\circ\text{C}$

Parameter	Symbol	Part Number	Min	Typ	Max	Units	Test Conditions
Input-Output Insulation	V_{ISO}	ACPL-M21L /024L/021L	3750			V_{rms}	RH < 50% for 1 min. $T_A = 25^\circ\text{C}$
		ACPL-W21L /K24L	5000				
Input-Output Resistance	R_{I-O}			10^{12}		Ω	$V_{I-O} = 500\text{ V}$
Input-Output Capacitance	C_{I-O}			0.6		pF	$f = 1\text{ MHz}$, $T_A = 25^\circ\text{C}$

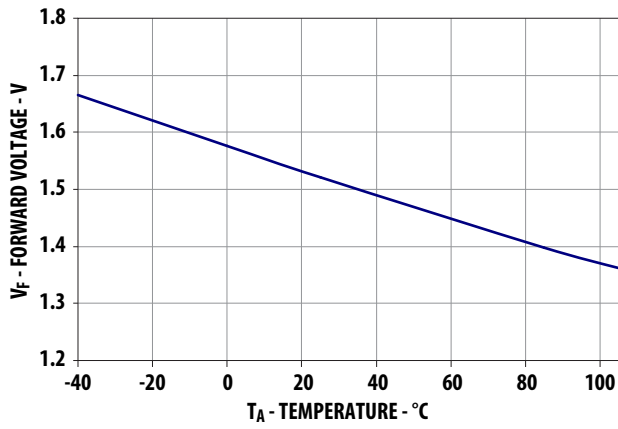

Figure 1. Forward Voltage vs. Temperature

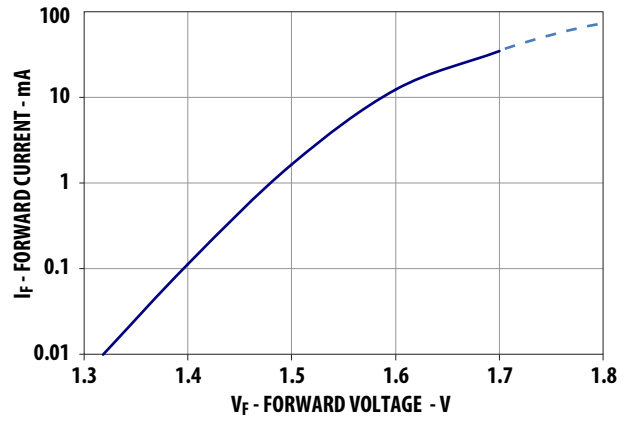

Figure 2. Forward Current vs Forward Voltage

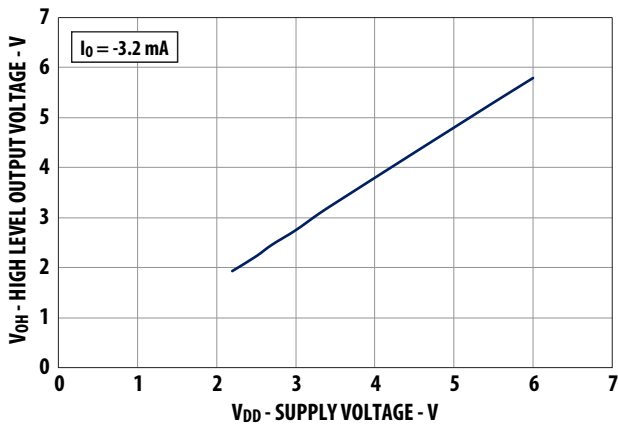

Figure 3. Logic High Output voltage vs Supply Voltage

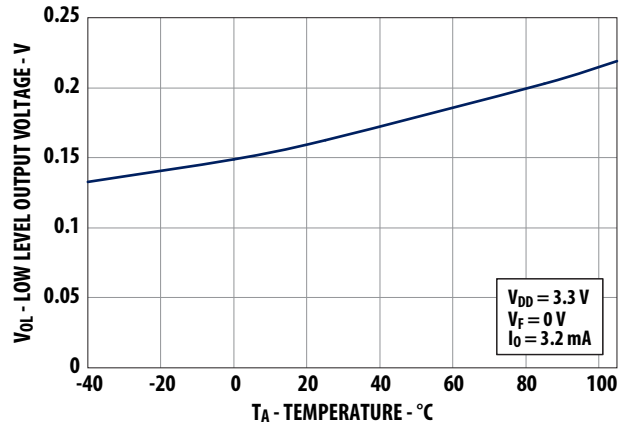

Figure 4. Logic Low Output Voltage vs. Temperature

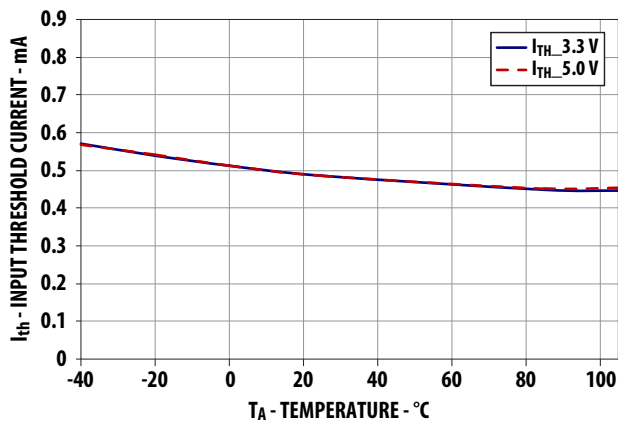

Figure 5. Input Threshold Current vs. Temperature

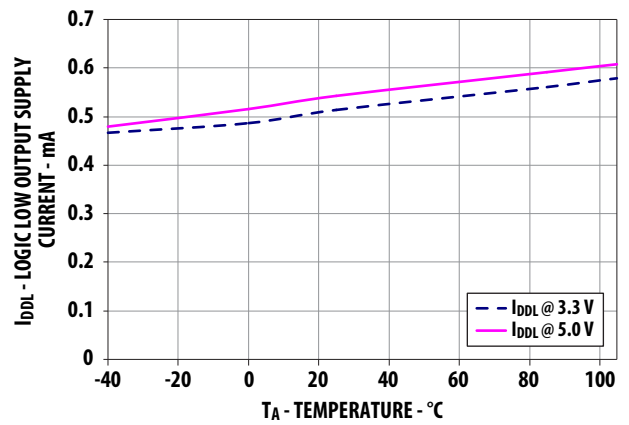

Figure 6. Logic Low Output Supply Current vs. Temperature

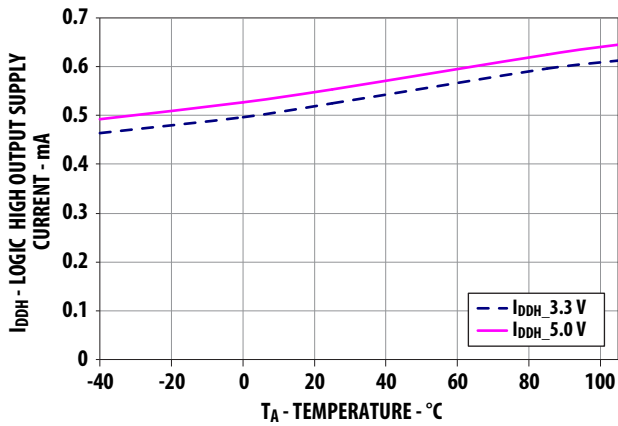

Figure 7. Logic High Output Supply Current vs. Temperature

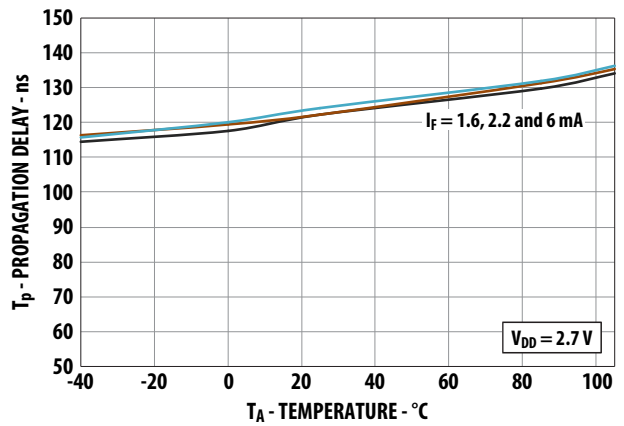

Figure 8. Propagation Delay, t_{pHL} vs. Temperature

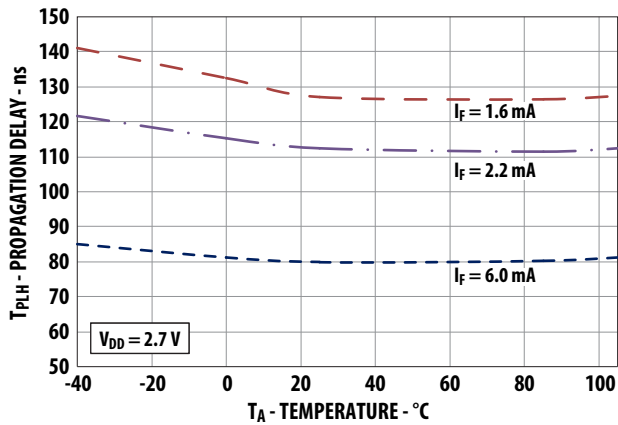

Figure 9. Propagation Delay, t_{pLH} vs. Temperature

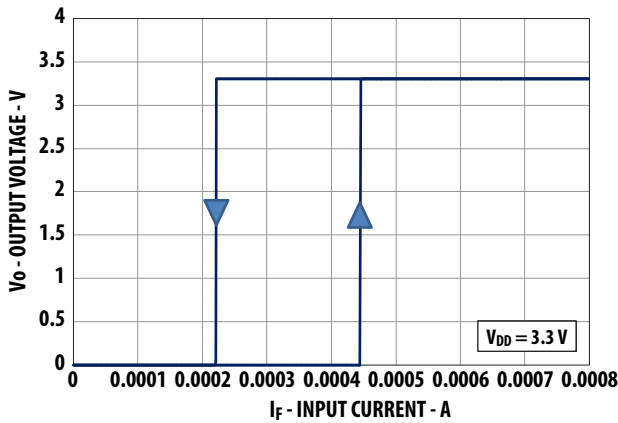

Figure 10. Output Voltage vs Input Current @ $V_{DD} = 3.3 V$

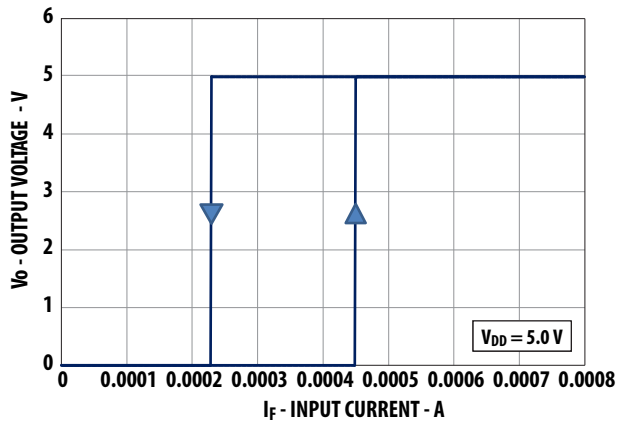

Figure 11. Output Voltage vs Input Current @ $V_{DD} = 5.0 V$

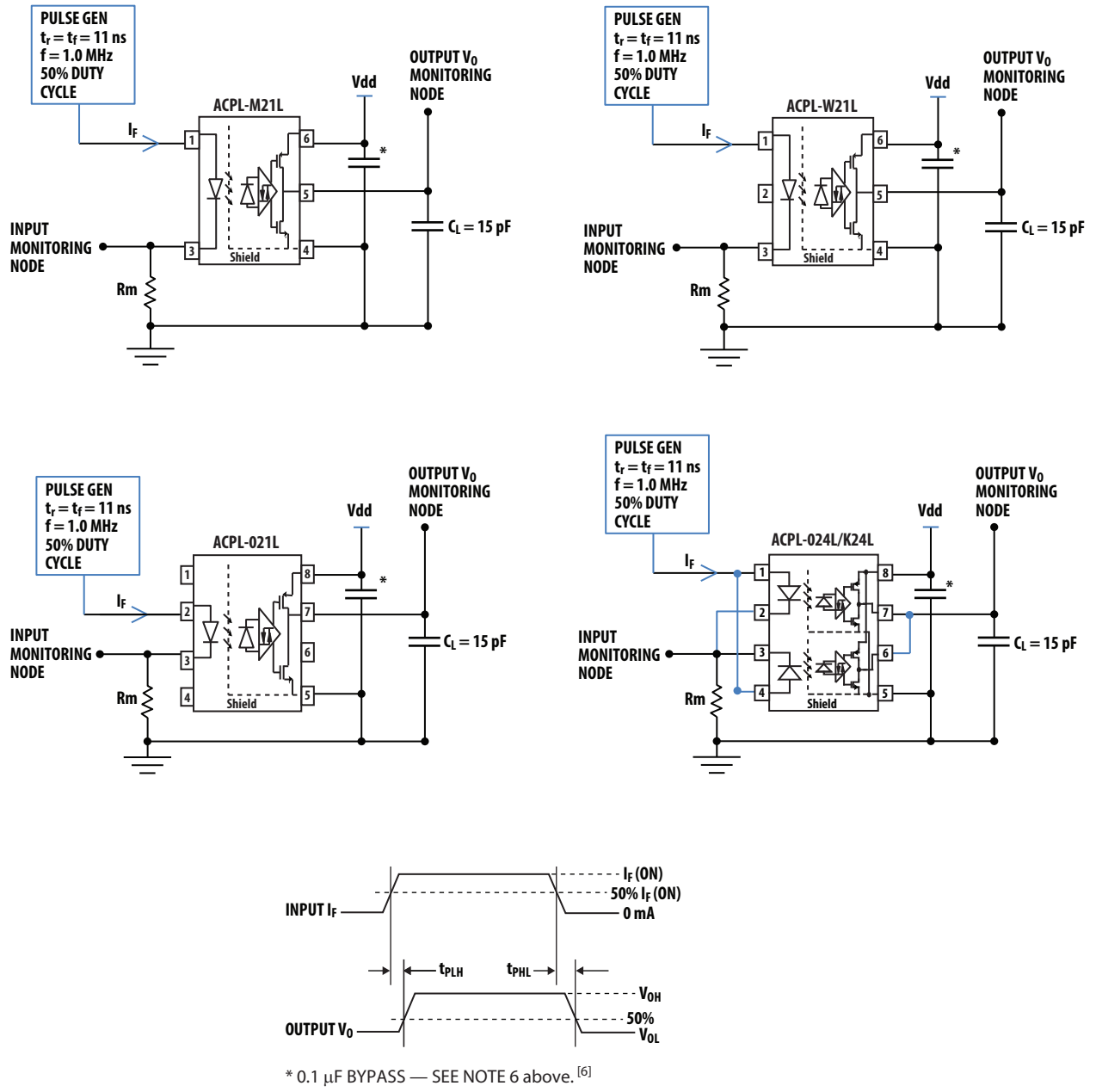

Figure 12. Circuit for t_{PLH} , t_{PHL} , t_r , t_f

ACPL-M21L, ACPL-021L, ACPL-024L, ACPL-W21L, ACPL-K24L :

$V_1 = 3.3\text{ V}$: $R_1 = 510\ \Omega \pm 1\%$, $R_2 = 330\ \Omega \pm 1\%$

$V_1 = 5.0\text{ V}$: $R_1 = 1\text{ k}\Omega \pm 1\%$, $R_2 = 600\ \Omega \pm 1\%$

$R_T = R_1 + R_2$ $R_1 / R_2 \approx 1.5$

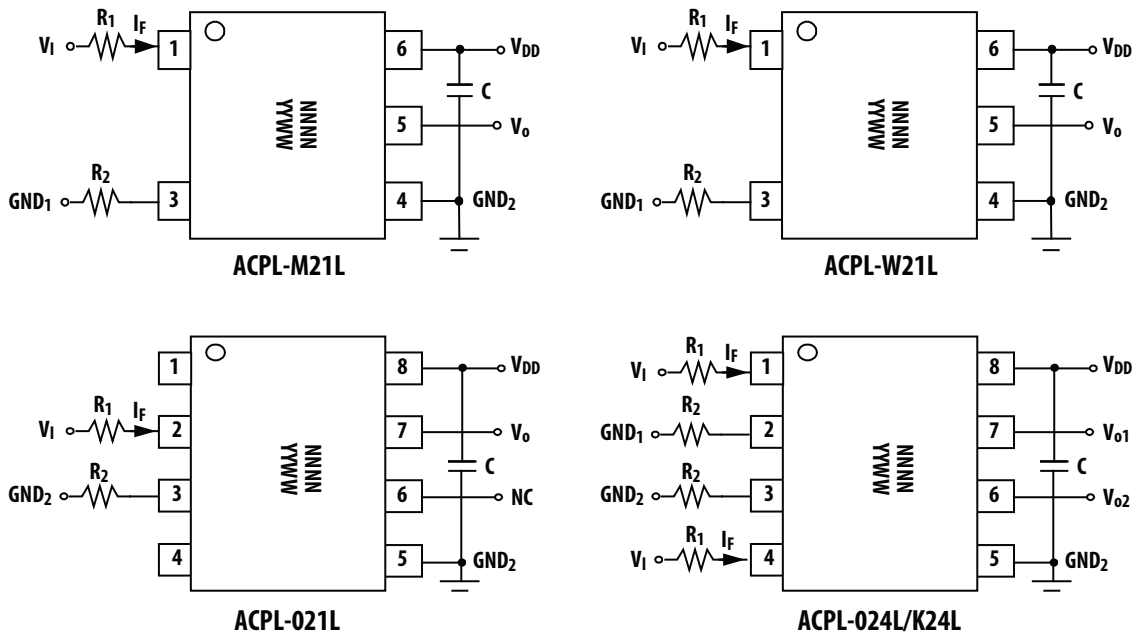

Figure 13. Recommended printed circuit board layout and input current limiting resistor selection

For product information and a complete list of distributors, please go to our web site: www.avagotech.com

Avago, Avago Technologies, and the A logo are trademarks of Avago Technologies in the United States and other countries. Data subject to change. Copyright © 2005–2013 Avago Technologies. All rights reserved. AV02-3462EN - December 6, 2013

