

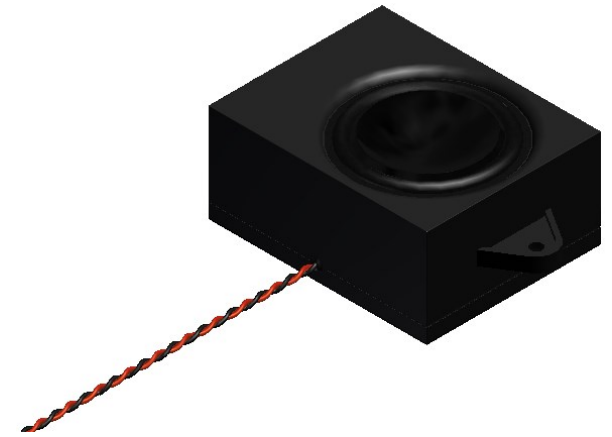

pui
audio™ inc
a projects unlimited company

ASE04508MR-LW150-R 45mm Enclosed Speaker



3541 Stop Eight Road • Dayton, Ohio 45414

Product Overview

- 30 x 25mm speaker with 150mm lead wires for instant integration
- 3W continuous, 5 maximum power handling and 8Ω impedance
- Rugged ABS enclosure designed for optimum sound

Frequency Response (1W @ 0.5 meters)

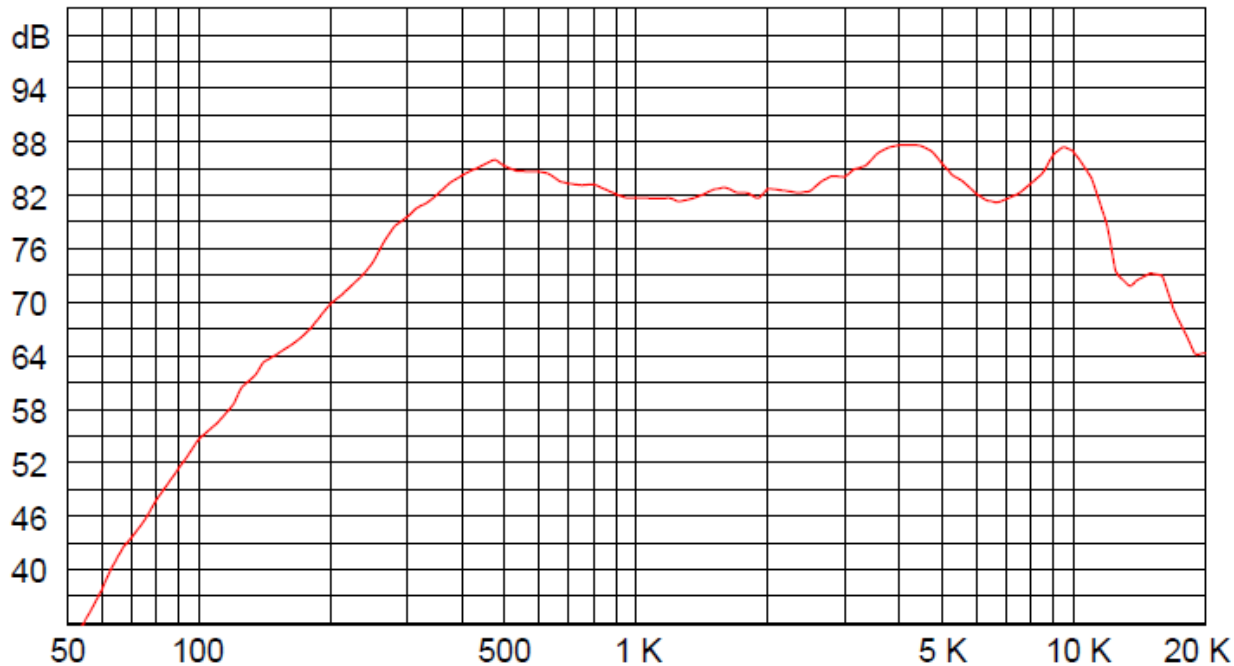

An Initiative of the EICC and GeSI



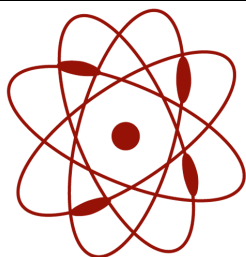

pui audio[™]
a projects unlimited company

ASE04508MR-LW150-R 45mm Enclosed Speaker

Mechanical and Environment Testing

Test Description	Test Condition
High Temperature	60°C ±2°C with random humidity for 96 hours
Low Temperature	-25°C ±2°C with random humidity for 96 hours
Humidity	40°C ±3°C with 90% to 95% relative humidity for 96 hours
Vibration	1.5 mm movement modulated at 10 to 55 Hz for 2 hours
Drop Test	75 cm free fall onto concrete floor, 10 cycles
Temperature Cycle Test	-25°C to 60°C, 4 cycles (refer to Temperature Cycle Test Graph)

After tests, speaker shall rest for 1 hours. SPL shall not deviate ±4 dB from pre-test measurement.

Temperature Cycle Test Graph

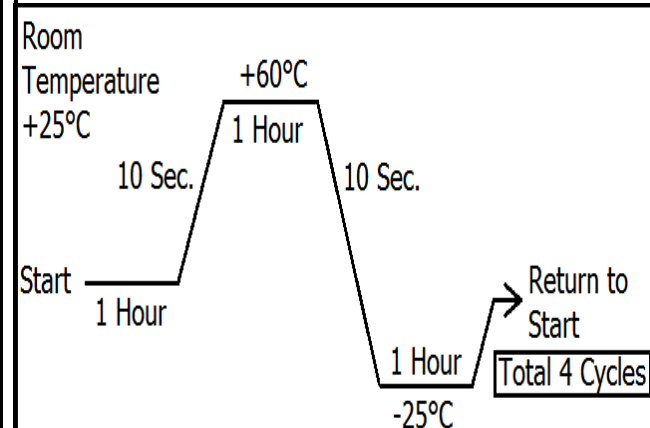

Frequency Response and SPL Measurement Setup

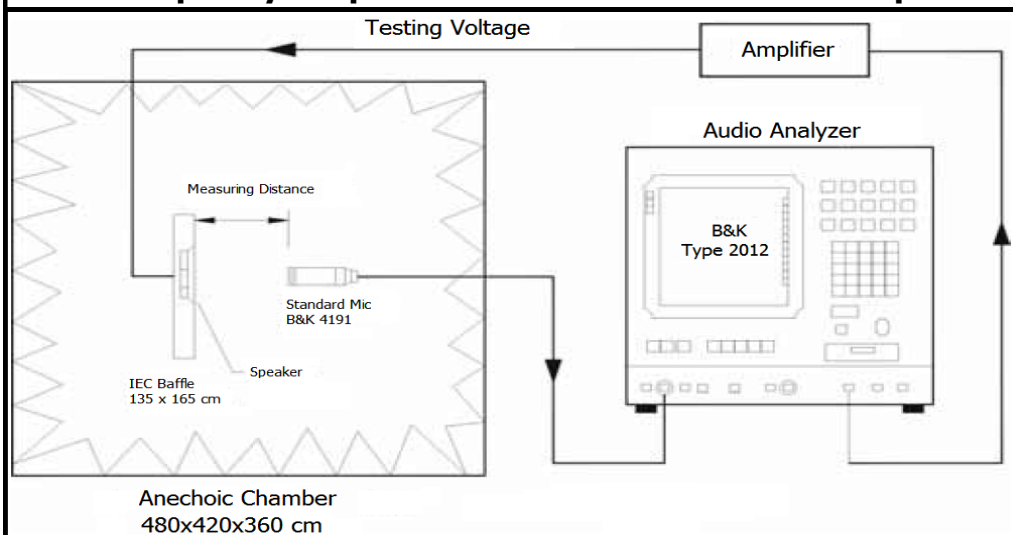

Speaker Parameters

Specification	ASE04508MR
F _o (Hz)	280
Frequency Range	250 ~ 12,000
Impedance (ohm)	8
SPL (dB) @ 1W/0.5m	82

SPECIFICATIONS

PARAMETERS	VALUES	UNITS
RATED INPUT POWER	3	W
MAX INPUT POWER	5	W
IMPEDANCE	8 ± 15%	OHM
OUTPUT SPL @ 1W/0.5M (AT 0.8, 1.0, 1.2, 1.5 kHz)	82 ± 3	dBA
DISTORTION (MAX.)	5%	-
RESONANT FREQUENCY	280 ± 20%	Hz
FREQUENCY RANGE	250 ~ 12,000	Hz
HOUSING MATERIAL	ABS	-
CONE MATERIAL	MYLAR	-
MAGNET MATERIAL	RARE EARTH	-
OPERATING TEMPERATURE	-25 ~ +60	°C
WEIGHT	27	grams

THIS DOCUMENT CONTAINS DATA PROPRIETARY TO PROJECTS UNLIMITED, INC. ANY USE OR REPRODUCTION, IN ANY FORM, WITHOUT PRIOR WRITTEN PERMISSION OF PROJECTS UNLIMITED, INC. IS PROHIBITED.
©2003, Projects Unlimited Inc.

REVISION HISTORY

LTR	DESCRIPTION	DATE	APPROVED
-	RELEASED FROM ENGINEERING	1/23/2014	

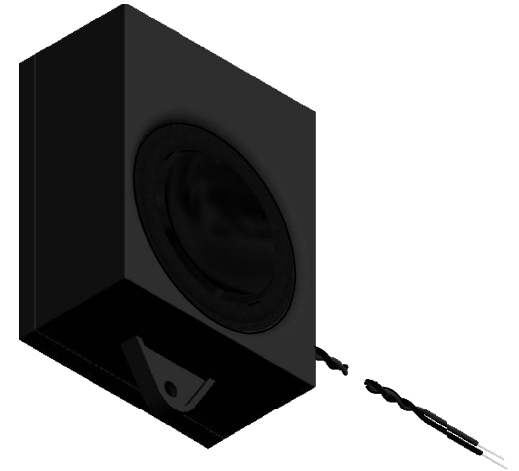
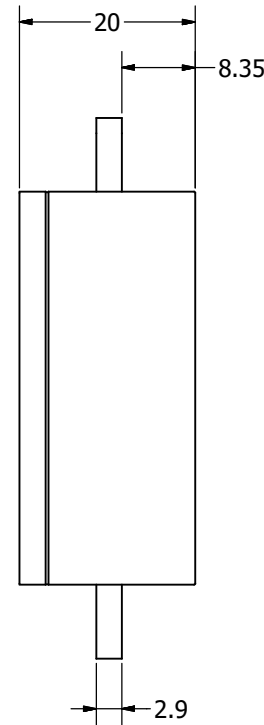
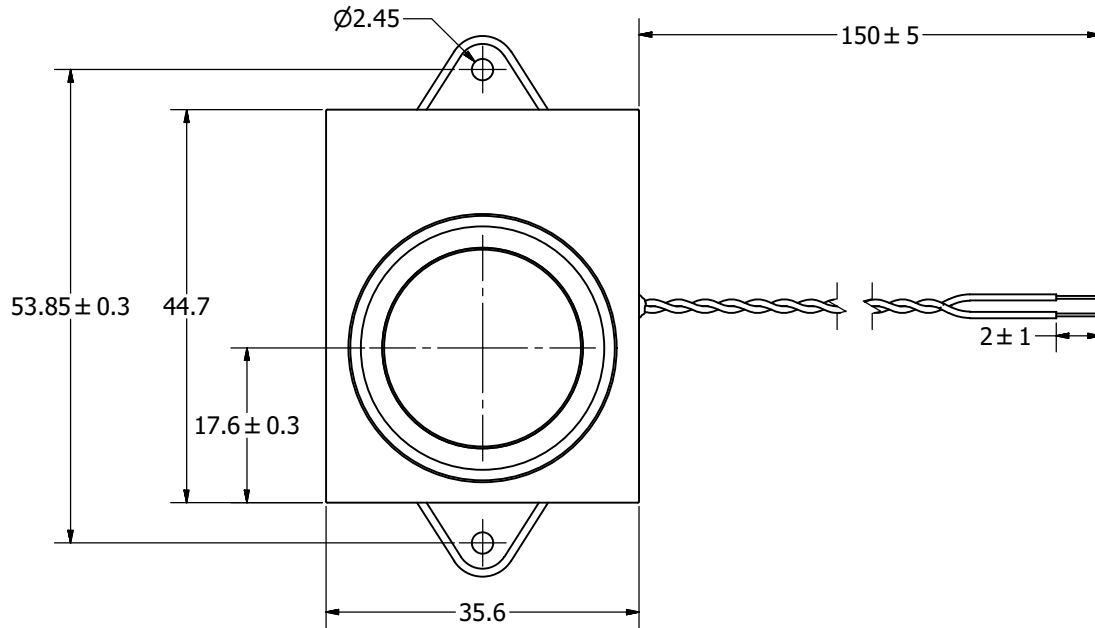

NOTES:

1. ALL DIMENSIONS ARE IN MILLIMETERS.
2. SPECIFICATIONS SUBJECT TO CHANGE OR WITHDRAWAL WITHOUT NOTICE.
3. THIS PART IS RoHS 2011/65/EU COMPLIANT.

UNLESS OTHERWISE SPECIFIED: DIMENSIONS ARE IN MILLIMETERS, TOLERANCES ARE ±0.5 AND ANGLES ARE ±3°.	SIZE A3	Designed by	Date	Checked by	Date	Approved by	Date	Drawn Date	
		J.D.	1/17/2014	M.L.	1/17/2014	B.R.	1/17/2014	1/17/2014	
ASE04508MR-LW150-R.idw		 pui audio a projects unlimited company			ASE04508MR-LW150-R Speaker			Edition -	Sheet 1 / 1

Mouser Electronics

Authorized Distributor

Click to View Pricing, Inventory, Delivery & Lifecycle Information:

[PUI Audio:](#)

[ASE04508MR-LW150-R](#)