

Interactive Catalog Supplements Catalog PDFs

If you need detailed product information, or help choosing the right product for your application, see our [Interactive Catalog](#). Use the [Interactive Catalog](#) to access the most complete and up-to-date information available.

The [Interactive Catalog](#) provides an extensive collection of product specifications, application data, and technical literature that can be searched based on criteria you select.

This PDF catalog information was published in November 2000.



Sensing and Control
[Interactive Catalog...](#)

**Click this icon to try
the Interactive Catalog.**

Sensing and Control
Honeywell Inc.
11 West Spring Street
Freeport, IL 61032



www.honeywell.com/sensing

Manual Switches

Advanced Manual Line

Solid state switches — AML10 series

AML11/12 pushbutton switches 12/13

Electronic control switches — AML20 series

AML21/22 pushbutton switches 14/15
AML23/25 paddle switches 16/17
AML24/26 rocker switches 18/19
AML27 keylock switches 20

Power duty switches — AML30 series

AML31/32 pushbutton switches 21
AML33/35 paddle switches 22
AML34/36 rocker switches 23

Indicators, Annunciators — AML40 series

AML41/42 indicators 24
AML45 annunciators 25

Buttons, rockers, covers, cap assemblies — AML50 series

AML59 annunciator cap assemblies 28
AML51/52 pushbutton switch and indicator buttons 30/31
AML53/55 paddle switch covers 35/36
AML54/56 rocker switch operators 30/40

Mounting hardware — AML60 series

AML61 mounting bracket assembly 43

Accessories — AML70 series

AML71 barriers and AML75 panel seals 44
AML76 switch guards and AML78 panel plugs, dummy housing 45
AML79 connector block 45

Lamps and LEDs — AML90 series

AML91 incandescent wedge base T-1¾ lamps and AML92 T-1¾ LEDs. 46

Mounting dimensions 47

Manual Switches

Advanced Manual Line

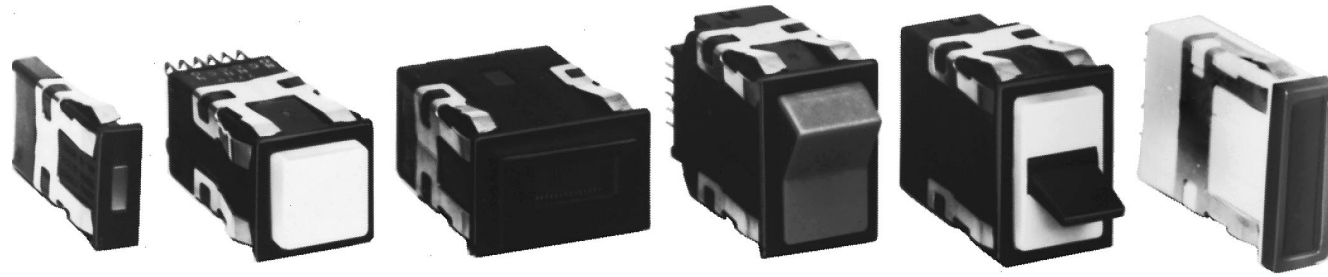

IN FRONT OF THE PANEL

Coordinated, attractive appearance. AML features innovations designed by industrial designers to achieve the best balance of human factors and aesthetic appearance. Operator height, bezel size, and the compatibility of square and rectangular shapes blend with other components to harmonize your panel. There's no visual clutter to distract from man/machine communication.

This comprehensive line of lighted and unlighted manual controls features:

- Pushbuttons for high and intermediate frequency functions;
- Rocker and paddle switches, with 2 or 3 positions, for less frequent control functions;
- Plus lighted indicators and annunciators which complement AML's universal appeal.

Various controls can be matched with their functions to accommodate the most natural and efficient habit pattern reflex. Keylock operated switches can be used to assure "authorized personnel only" access.

Display flexibility. AML offers a choice of five legend sizes, four button heights, full or split section display, and illumination by incandescent lamps, LED's or neons. Colors are bright and uniform, providing a strong definition and good visibility. (Non-illuminated devices have the same attractive colors.)

Color display options include:

- Transmitted color — color can be distinguished whether lamp is On or Off.
- Dead front — display appears black, until illumination causes legend and color to appear.
- Projected color — white display is diffused with color when illuminated.

BEHIND THE PANEL

AML's simple, cost effective design provides many behind-panel benefits for the designer and installer/user.

Simple to install. They snap in from the panel front individually or in vertical or horizontal strips; or in subpanel mounted strips and matrices that can be pre-assembled and pre-wired to assure accurate alignment and efficient panel building.

Electrical flexibility. Solid state switches with Hall effect integrated circuits interface directly with microprocessors and other logic level devices. These IC's were first applied in MICRO SWITCH solid state keyboards. Today, many MICRO SWITCH products incorporate the Hall effect technology to meet a wide range of position sensing and manual control needs.

Electronic control switches with gold or silver contacts, and 1, 2, or 4 poles, will handle up to 3 amps. Including an encoded version which generates different binary coded outputs merely by changing cam-keyed buttons.

Power duty switches meet line disconnect application needs with 10-amp push-buttons and 15-amp paddle and rocker switches.

Easy to wire. All AML devices present single level termination. This means faster, easier, neater, and more economical wiring. And there is a choice of solder, quick-connect, push-on, and printed circuit termination.

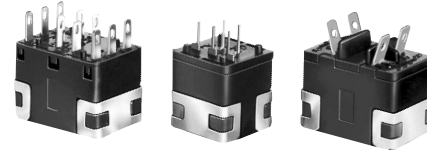

MATING RECEPTACLES

The .110 x .020 quick-connect/solder terminal (types 2 and 8) is designed for use with receptacles that comply with the UL standard for insertion and withdrawal forces. Maximum insertion force is 12 lbs. max., withdrawal force is 14 lbs. These receptacles are supplied by: AMP Inc., Berg, Augat, Hollingsworth, MALCO, Zierick, and others. Refer to Thomas Register or the Yellow Pages for the location of your local supplier.

Manuals

Manual Switches

Advanced Manual Line

FEATURES

- Complete selection of pushbutton, rocker and paddle (toggle type) switches accommodates different functions and promotes operator efficiency.
- Solid state, electronic, and power duty control.
- Full or split screen incandescent display switches and indicators provide vivid transmitted color, projected color (for neutral display when unlit), and dead front (hidden color).
- Wide-angle visibility LED and line voltage neon display switches and indicators.
- Annunciators back-lighted by LED's enable high density message display.
- Keylock switches available for controlled access applications.
- All AML terminations at the same shallow depth (1.7 in. /43,1 mm) for convenient wiring or PC board termination.
- Snap-in surface mount or sub-panel (hidden bezel) mount with mounting hardware.
- Pad printed legends with a clear polyurethane overcoat available in a choice of five standard sizes.
- Metric design for worldwide acceptance.
- UL recognized, CSA certification.
- Selected listings are certified by VDE and CE. (For compliance status, contact the 800 number.)

MICRO SWITCH AML Advanced Manual Line combines functional flexibility with electrical versatility to provide a broad range of options to choose from.

EASY TO RELAMP



Relamping of T-1-3/4 incandescent AML91 lamps is accomplished from the front of the panel without tools. (AML92 T-1-3/4 LEDs can be added in the same manner.)

FULL GUARD BEZEL OPTION



As an alternative to standard height bezels (.06 in./1,5 mm), pushbutton switches can be furnished with full guard bezels extending .19 in./5.0 mm from the mounting surface. In the free position, standard buttons are flush with full guard bezels.

The raised bezel guards against accidental operation by someone leaning against or dropping something on a control console.

High Intensity LEDs For Full-face AML Lighted Display AML92 Series



- Full-face illumination for high visibility lighted colors.
- Advanced illumination technology combines high-intensity LED in standard T-1-3/4 wedge base lamp package.
- Easy plug-in installation in AML lighted switches and indicators.
- Low operating temperature permits high density, continuous operation with minimal heat build-up.

AML92 Series LEDs have a quad chip assembled in a T-1-3/4 wedge base lamp package. They provide full-face illumination when used with lighted pushbutton, rocker and paddle switches, or indicators equipped with incandescent lamp sockets. For ordering information, refer to page 46.

Manual Switches

Advanced Manual Line

AML CHARACTERISTICS

	AML 10 Series	AML 20 Series	AML 30 Series	AML 40 Series
Electrical/Mechanical Life* Pushbuttons–Momentary	1,000,000	25,000 (silver)/ 100,000 (gold)	25,000	N/A ---
Pushbuttons–Alternate	25,000	25,000	25,000	---
Rockers	25,000	25,000	25,000	---
Paddles	25,000	25,000	25,000	---
Agency Ratings (May not apply to every series division)				
UL	File E53576	File E12252	File E12252	File E58932
CSA	File LR4442	File LR4442	File LR4442	File LR4442
VDE	None	File 0630/10.78+	File 0630/10.78+ +	None
CE		Rating 1710 No. 4275.5788	Rating 1710 No. 4275.5788	

*95% Survival
 + Exception: Four-Pole AML's are not included in VDE Approval
 ++ Exception: Only the 2-pole AML33 and AML34 are certified by VDE

AML ELECTRICAL DATA

● AML10 Series

Electrical Characteristics						Absolute Maximum Rating ④			
Integrated Circuit Function	Supply Current (Max.)	Output Voltage (Operated)	Output Leakage Current max. (Released)	Switching Time Max.		Supply Voltage (V _s)	Voltage Externally Applied to Output	Loads to Output	Storage Temperature
				Rise 10% to 90%	Fall 90% to 10%				
4.5-24 VDC Sinking	5 V 7.0 mA (Released) 24 V 9.0 mA (Released) 14.0 mA (Operated-no load)	+ .4 Volt (Sinking 10 mA)	10 μA	1.5 μ sec (Sinking 10 mA)	0.5 μ sec (Sinking 10 mA)	-30 to +30 VDC	-0.5 Volt min. +24 Volts max. (Off condition)	20 mA (Sinking)	-40–C to +65°C (-40° to +149°F)

① Over temperature range of 0° to +55°C (+32° to +131°F) and supply voltage of 4.5 to 5.5 VDC.
 ② Over temperature range of 0° to +55°C (+32° to +131°F) and supply voltage of 16 VDC.
 ③ At 24°C. (+75°F)
 ④ As with all solid state components, performance can be expected to deteriorate as rating limits are approached; however, they will not be damaged unless the limits are exceeded.

● AML20 Series

Contacts	Voltage	Current	Load Type
Silver or Gold-plated Silver	250 VAC 125 VAC 24 VDC	2 Amps 3 Amps 2 Amps	75% Power Factor 75% Power Factor Resistive
Gold	125 VAC/DC	100 mA	Resistive

● AML30 Series

Voltage	Current		Load Type
	Pushbuttons	Rockers or Paddles	
125 VAC	10 amps	15 amps	60% power factor
250 VAC	10 amps	15 amps	60% power factor

Manuals

Manual Switches

Solid State Pushbutton

INCANDESCENT OR NON-LIGHTED DISPLAY



Buttons ordered separately.

Electrical Data	page 11
Buttons	page 30
Lamps and LEDs	page 46
Accessories	pages 44/45
Mounting Dimensions	pages 47/48

FEATURES

- Hall effect reliability.
- Provides low voltage signals that interface with nearly all DC logic level loads.
- 4.5-24 VDC supply voltage.
- Full guard bezel option.
- Lamps can be furnished installed or ordered separately.
- UL recognized.
- Lamp circuit independent of switch circuit.

AML11 ORDER GUIDE

AML11 B		B	A	2	EA		
Housing Type		Bezel Color	Incandescent Lamp Type	Terminal Type	Circuitry Codes		
Standard Bezel: AML11B Square Non-Lighted AML11C Square 1 Lamp Ckt. AML11E Rect. Non-Lighted AML11F Rect. 1 Lamp Ckt. AML11G Rect. 2 Lamp Ckts. Full Guard Bezel: AML11H Square Non-Lighted AML11J Square 1 Lamp Ckt. AML11K Rect. Non-Lighted AML11L Rect. 1 Lamp Ckt. AML11M Rect. 2 Lamp Ckts.		B Black	A No Lamp Installed B 6 V Lamp* C 14 V Lamp* E 28 V Lamp*	2 .110 x .020 (Solder or Quick-Connect) 3 .025 x .025 (Printed Circuit, or Push-On)	4.5-24 VDC Sinking	EA Momentary Action	EE Alternate Action

* Lamps will be installed per each lamp circuit specified in the Housing Type.

Example: **AML11BBA2EA**
 Square pushbutton switch housing, non-lighted; black bezel; .110 x .020 termination; momentary action; current sinking output for use with 4.5 volt supply.

CURRENT SINKING OUTPUT
AML10 SERIES

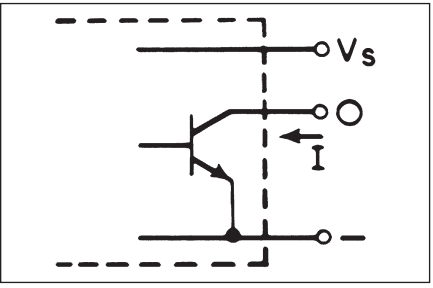

A permanent magnet plunger moves adjacent to the Hall effect integrated circuit to give a digital, current sinking normally high output.

Manual Switches

Solid State Pushbutton

LED DISPLAY



LED "window" buttons ordered separately.
LEDs are not replaceable.

FEATURES

- Hall effect reliability (Refer to facing page for electrical specifications.)
- Rectangular, high efficiency LED's give flush display area and wide angle indication.
- Available with or without diode protection for the LED's.
- 4.5 thru 24 VDC devices have an internal resistor to maintain LED current at nominal 20 mA.

Electrical Data	page 11
Buttons	pages 30/31
Lamps and LEDs	page 46
Accessories	pages 44/45
Mounting Dimensions	pages 47/48

- LED circuit independent of switch circuit.
- UL recognized.

AML12 ORDER GUIDE

AML12C

Housing Type

Standard Bezel:
AML12C Square 1 LED

Full Guard Bezel:
AML12J Square 1 LED

B

Bezel Color

B
Black

B

LED Color/ Voltage

Red
B V*
C 5 V
D 10 V
E 15 V
F 24 V
Yellow
H V*
J 5 V
K 10 V
L 15 V
M 24 V
Green
R V*
S 5 V
T 10 V
W 15 V
X 24 V

2

Terminal Type/ Diode Protection

2
.110 × .020
(Solder or
Quick-Connect)

3
.025 × .025
(Printed Circuit
or Push-On)

8
.110 × .020
With Diode
Protection

EA

Circuitry Codes

4.5-24 VDC Sinking	EA Momentary Action	EE Alternate Action
--------------------------	----------------------------------	----------------------------------

Example: **AML12CBB2EA**
Square pushbutton switch housing;
black bezel; red LED; .110 × .020 termina-
tion; current sinking output for use with 4.5
volt supply; momentary action.

* See LED application information for devices
without current-limiting resistor, page 46.

Manual Switches

Electronic Control Pushbutton

AML21 Series

INCANDESCENT OR NON-LIGHTED DISPLAY

Electrical Data	page 11
Buttons	page 30/31
Lamps and LEDs	page 46
Accessories	pages 44/45
Mounting Dimensions	pages 47/50



Buttons ordered separately.

FEATURES

- 1, 2, or 4 poles.
- Silver or gold contacts.
- Full guard bezel option.
- Momentary or 2-level alternate action (push-on, push-off).
- UL recognized, CSA certified.
- Lamps can be furnished installed or ordered separately.
- Lamp circuit independent of switch circuit.



*AML21 Series: 1 pole and 2-pole only.

AML21 ORDER GUIDE

AML21 B

Housing Type	Bezel Color	Incandescent Lamp Type	Terminal Type	Circuitry Codes (Each pole has double-throw)									
Standard Bezel: AML21B Square Non-Lighted AML21C Square 1 Lamp Ckt. AML21E Rect. Non-Lighted AML21F Rect. 1 Lamp Ckt. AML21G Rect. 2 Lamp Ckts.	B Black	A No Lamp Installed B 6 V Lamp* C 14 V Lamp* E 28 V Lamp*	2 .110 × .020 (Solder or Quick-Connect) 3 .025 × .025 (Printed Ckt. or Push-On)	<table border="1"> <tr> <td rowspan="2">Silver Contacts</td> <td>Mom. Action AA 1-Pole AC 2-Pole CC 4-Pole</td> </tr> <tr> <td>Alt. Action AB 1-Pole AD 2-Pole CD 4-Pole</td> </tr> <tr> <td rowspan="2">Gold Contacts</td> <td>Mom. Action BA 1-Pole BC 2-Pole DC 4-Pole</td> </tr> <tr> <td>Alt. Action BB 1-Pole BD 2-Pole DD 4-Pole</td> </tr> <tr> <td rowspan="2">Gold-Plated Silver Contacts</td> <td>Mom. Action EA 1-Pole EC 2-Pole</td> </tr> <tr> <td>Alt. Action EB 1-Pole ED 2-Pole</td> </tr> </table>	Silver Contacts	Mom. Action AA 1-Pole AC 2-Pole CC 4-Pole	Alt. Action AB 1-Pole AD 2-Pole CD 4-Pole	Gold Contacts	Mom. Action BA 1-Pole BC 2-Pole DC 4-Pole	Alt. Action BB 1-Pole BD 2-Pole DD 4-Pole	Gold-Plated Silver Contacts	Mom. Action EA 1-Pole EC 2-Pole	Alt. Action EB 1-Pole ED 2-Pole
Silver Contacts	Mom. Action AA 1-Pole AC 2-Pole CC 4-Pole												
	Alt. Action AB 1-Pole AD 2-Pole CD 4-Pole												
Gold Contacts	Mom. Action BA 1-Pole BC 2-Pole DC 4-Pole												
	Alt. Action BB 1-Pole BD 2-Pole DD 4-Pole												
Gold-Plated Silver Contacts	Mom. Action EA 1-Pole EC 2-Pole												
	Alt. Action EB 1-Pole ED 2-Pole												

* Lamps will be installed per each lamp circuit specified in the Housing Type.

Example: **AML21BBA2AA**

Square pushbutton switch housing non-lighted; black bezel; .110 × .020 termination; momentary action; 1-pole, double-throw; silver contacts.

Manual Switches

Electronic Control Pushbutton

LED DISPLAY



Buttons with LED "window" ordered separately. LEDs are not replaceable.

FEATURES

- Identical to AML21 switches, except furnished with high efficiency LED display.
- Rectangular LED's are flush with button surface, providing wide angle indication.
- Optional diode protection for LED's.
- 5 thru 24 VDC LED devices have an internal resistor to maintain current at nominal 20 mA.
- UL recognized, CSA certified.
- LED circuit independent of switch circuit.

Electrical Data	page 11
Buttons	pages 30/31
Lamps and LEDs	page 46
Accessories	pages 44/45
Mounting Dimensions	pages 47/50



*AML22 Series: 1 pole and 2-pole only.

AML22 ORDER GUIDE

AML22 C

Housing Type

Standard Bezel:
AML22C Square 1 LED
AML22H Square 1 High-Profile LED (For use with AML52-A buttons)

Full Guard Bezel:
AML22J Square 1 LED

B

Bezel Color

B
 Black

B

LED Color/ Voltage

Red
B V*
C 5V
D 10V
E 15V
F 24V
Yellow
H V*
J 5V
K 10V
L 15V
M 24V
Green
R V*
S 5V
T 10V
W 15V
X 24V

2

Terminal Type

2
 .110 × .020
 (Solder or Quick-Connect)

3
 .025 × .025
 (Printed Ckt., or Push-On)

8
 .110 × .020
 With Diode Protection for LED

AA

Circuitry Codes (Each pole has double-throw)

Silver Contacts	Mom. Action AA 1-Pole AC 2-Pole CC 4-Pole
	Alt. Action AB 1-Pole AD 2-Pole CD 4-Pole
Gold Contacts	Mom. Action BA 1-Pole BC 2-Pole DC 4-Pole
	Alt. Action BB 1-Pole BD 2-Pole DD 4-Pole
Gold-Plated Silver Contacts	Mom. Action EA 1-Pole EC 2-Pole
	Alt. Action EB 1-Pole ED 2-Pole

Manuals

* See LED information for devices without current limiting resistor, page 46.

Example: **AML22CBB2AA**

Square pushbutton switch housing with one LED, black bezel; red LED (without resistor); .110 × .020 termination; momentary action, 1-pole, double-throw; silver contacts.

CONTACT ARRANGEMENT

1, 2 or 4 poles: Form C



Manual Switches

Electronic Control Paddle

INCANDESCENT OR NON-LIGHTED DISPLAY

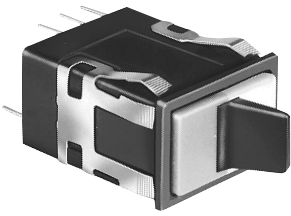

Covers ordered separately.

FEATURES

- Silver or gold contacts.
- 1, 2 or 4 poles.
- Toggle type paddle operators permanently installed in rectangular housings.
- Covers for the switch housing may be lighted or unlighted.
- UL recognized, CSA certified.
- Lamps can be furnished installed or ordered separately.
- Lamp circuit independent of switch circuit.

Electrical Data	page 11
Paddle Covers	page 35
Lamps and LEDs	page 46
Accessories	page 45
Mounting Dimensions	pages 47/50



*AML23 Series: 1 pole and 2-pole only.

*AML23 ORDER GUIDE

AML23 E	B	A	2	AA	01
Housing Type	Operator/Bezel Color	Incandescent Lamp Type	Terminal Type	Circuitry Codes	Operating Action
AML23 E Rectangular Non-Lighted AML23 F Rectangular 1 Lamp Ckt. (A) AML23 G Rectangular 2 Lamp Ckts. (A & B)	B Black/Black	A No Lamp Installed B 6 V Lamp* C 14 V Lamp* E 28 V Lamp*	2 .110 × .020 (Solder or Quick-Connect) 3 .025 × .025 (Printed Ckt., or Push-on)	Insert Code letters as shown in Circuitry Chart	Insert Code numbers from Operating Action Chart

* Lamps will be installed per each lamp circuit specified in the Housing Type.

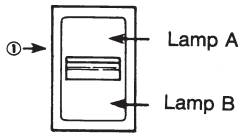

① The "MICRO SWITCH" identification is shown on this side of the switch housings.

Example: AML23EBA2AA01

Rectangular non-lighted paddle switch housing; black paddle and bezel; .110 × .020 terminals; with one circuit ON and one circuit OFF in each extreme operator position (maintained).

CIRCUITRY

Silver Contacts	Gold Contacts	2-Position		3-Position		
AA	BA					
AC	BC					
(Non-illuminated switches only)						
CA	DA					
CC	DC					
(Non-illuminated switches only)						

OPERATING ACTION

2-Position:		
Maint.	01 None	Maint.
Mom.	02 None	Maint.
Maint.	03 None	Mom.
3-Position:		
Maint.	04 Maint.	Maint.
Mom.	05 Maint.	Mom.
Maint.	06 Maint.	Mom.
Mom.	07 Maint.	Maint.

Manual Switches

Electronic Control Paddle

LED DISPLAY

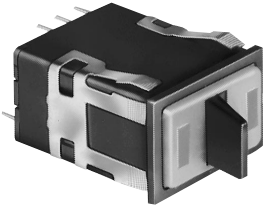

Covers with LED "window" ordered separately.

FEATURES

- Identical to AML23, except furnished with one or two rectangular high efficiency LED's which give flush display area and wide angle indication.
- Available with or without diode protection for LED's.
- LED circuit independent of switch circuit.

Electrical Data	page 11
Paddle Covers	page 36
Lamps and LEDs	page 46
Accessories	page 45
Mounting Dimensions	pages 47/50

- 5 thru 24 VDC devices have internal resistor to maintain current at nominal 20 mA.
- UL recognized, CSA certified.



*AML25 Series: 1 pole and 2-pole only.

AML25 ORDER GUIDE

Housing Type	Operator/ Bezel Color	LED Voltage	Terminal Type/ Diode Protection	Circuitry Codes	Operating Code	LED Color (LED A)	LED Color (LED B)
AML25 F Rectangular 1 LED	B Black/Black	B V*	2 .110 x .020 (Solder or Q-C)	Insert code letters as shown in Circuitry Chart	Insert code numbers from Operating Action Chart	R Red	R Red
AML25 G Rectangular 2 LED's		C 5 V	3 .025 x .025 (Printed Ckt., or Push-On)	LED version available only with AA BA CA DA circuitry		Y Yellow	Y Yellow
		D 10 V	8 .110 x .020 w/Diode protection			G Green	G Green
		E 15 V				X No LED	X No LED
		F 24 V					

* See LED application information for devices without current-limiting resistor, page 46.

Example: **AML25FBB2AA01RX**
Rectangular paddle switch; illuminated with one red LED, this device has a black paddle and bezel, and .110 x .020 terminals; with one circuit ON and one circuit OFF in each extreme operator position (maintained).

NOTE: For further information on replacement LED's, call the 800 number.

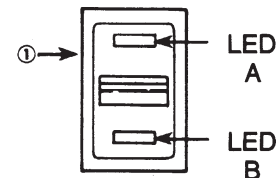
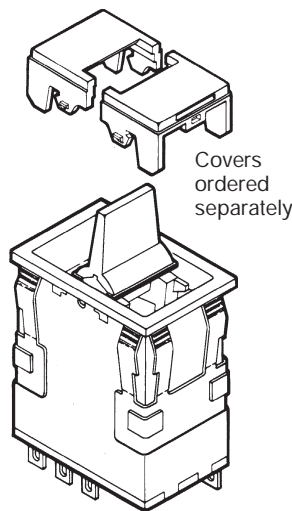

① The "MICRO SWITCH" identification is shown on this side of the switch housings.

Manuals

Manual Switches

Electronic Control Rocker

INCANDESCENT OR NON-LIGHTED DISPLAY

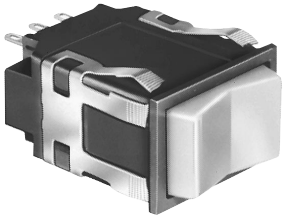

FEATURES

- Silver or gold contacts.
- 2 or 3 position operation.
- UL recognized, CSA certified.
- Lamps can be furnished installed or ordered separately.
- Lamp circuit independent of switch circuit.

Electrical Data	page 11
Rockers	page 39
Lamps	page 46
Accessories	pages 44/45
Mounting Dimensions	pages 47/50



*AML24 Series: 1 pole and 2-pole only.

Rocker operators ordered separately.

AML24 ORDER GUIDE

AML24 E	B	A	2	AA	01
Housing Type	Bezel Color	Incandescent Lamp Type	Terminal Type	Circuitry Codes	Operating Action
AML24 E Rectangular Non-Lighted AML24 F Rectangular 1 Lamp Ckt. (A) AML24 G Rectangular 2 Lamp Ckts.	B Black	A No Lamp Installed B 6 V Lamp* C 14 V Lamp* E 28 V Lamp*	2 .110 × .020 (Solder or Quick-Connect) 3 .025 × .025 (Printed Ckt., or Push-on)	Insert Code letters as shown in Circuitry Chart	Insert Code numbers from Operating Action Chart

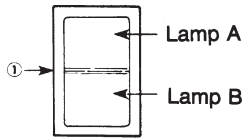

① The "MICRO SWITCH" identification is shown on this side of the switch housings.

* Lamps will be installed per each lamp circuit specified in the Housing Type.

Example: AML24EBA2AA01

Rectangular non-lighted rocker switch housing; black bezel; .110 × .020 terminals; with one circuit ON and one circuit OFF in each extreme operator position (maintained).

CIRCUITRY

Silver Contacts	Gold Contacts	2-Position		3-Position			
AA	BA						
AC (Non-illuminated switches only)	BC						
CA	DA						
CC (Non-illuminated switches only)	DC						

OPERATING ACTION

2-Position:		
Maint.	01 None	Maint.
Mom.	02 None	Maint.
Maint.	03 None	Mom.
3-Position:		
Maint.	04 Maint.	Maint.
Mom.	05 Maint.	Mom.
Maint.	06 Maint.	Mom.
Mom.	07 Maint.	Maint.

Manual Switches

Electronic Control Rocker

LED DISPLAY

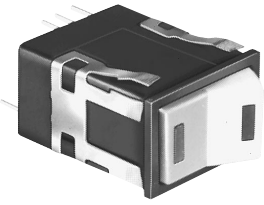

Rocker operators ordered separately.

LEDs are not replaceable.

FEATURES

- Identical to AML24, except furnished with one or two rectangular high efficiency LED's which give flush display area and wide angle indication.
- Available with or without diode protection for LED's.
- LED circuit independent of switch circuit.

Electrical Data	page 11
Rockers	page 40
Lamps and LEDs	page 46
Accessories	page 45
Mounting Dimensions	pages 47/50

- 5 thru 24 VDC LED devices have internal resistor to maintain current at nominal 20 mA.
- UL recognized, CSA certified.



*AML26 Series: 1 pole and 2-pole only.

AML26 ORDER GUIDE

AML26 F	B	B	2	AA	01	R	X
Housing Type	Bezel Color	LED Voltage	Terminal Type/ Diode Protection	Circuitry Codes	Operating Action	LED Color (LED A)	LED Color (LED B)
AML26 F 1 LED	B Black	B V*	2 .110 × .020 (Solder or Quick-Connect)	Insert code letters as shown in Circuitry Chart	Insert code numbers from Operating Action Chart	R Red	R Red
AML26 G 2 LED's		C 5 V	3 .025 × .025 (Printed Ckt., or Push-On)	LED version available only with AA, BA, CA, DA circuitry		Y Yellow	Y Yellow
		D 10 V	8 .110 × .020 w/Diode for LED protection			G Green	G Green
		E 15 V				X No LED	X No LED
		F 24 V					

* See LED application information for devices without current-limiting resistor, page 46.

Example: **AML26FBB2AA01RX**

Rectangular rocker switch; illuminated with one LED, this device has a black bezel, .110 × .020 terminals; with one circuit ON and one circuit OFF in each extreme operator position (maintained).

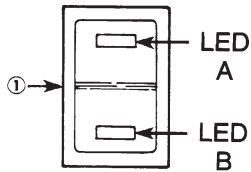

① The "MICRO SWITCH" identification is shown on this side of the switch housings.

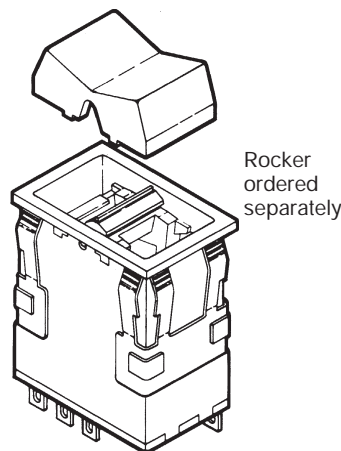

Rocker ordered separately

Manuals

Manual Switches

Electronic Control Keylock

NON-LIGHTED

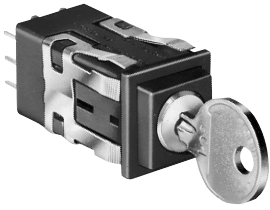

FEATURES

- Enable control of access to computer peripherals, keyboards, point-of-sale terminals, and security systems which are locked when unattended; and other locations where tampering must be discouraged.
- 2 or 3 positions, maintained (90° throw) and momentary action (60° throw).
- 5-bit key combinations

Electrical Data	page 11
Accessories	pages 44/45
Mounting Dimensions	pages 47/50

- UL recognized, CSA certified.
- Static discharge protection (up to 20 kV when grounded).

AML27 ORDER GUIDE

AML27 A	B	K	2	AA	21	BA
Housing Type	Bezel Color	Button Color	Terminal Type	Circuitry Codes (Each pole has double-throw)	Operation Action (Key out in center position, except where noted)	
AML27 A	B	K	2	Silver Contacts: AA 1 pole AC 2 pole	CCW	Center
Square housing	Black	Black	.110 x .020 (Solder or Quick-Connect)	Gold Contacts: BA 1 pole BC 2 pole	Center	CW
Non-Lighted			3		None	21
			.025 x .025 (Printed Circuit or Push-On)		Maint.	Maint.
					None	22*
					Maint.	Maint.
					None	23
					Maint.	Mom.
					Maint.	24
					Mom.	Maint.
					Maint.	25
					Mom.	Mom.
					Maint.	26**
					Maint.	Maint.
					Mom.	27***
					Maint.	Maint.
					Maint.	28***
					Maint.	Maint.
					Maint.	29†
					Maint.	Maint.
					Maint.	30†
					Maint.	Mom.
					Maint.	31††
					Maint.	Mom.

Key Combinations

(Two Keys Furnished)

BA	BS
BB	BT
BD	BV
BE	BW

28 and 29 operating actions should be used with Key Combinations BA and BB.

REPLACEMENT KEYS

One key per listing.

Key Combination	Key Code	Catalog Listing
BA	110	30PA101-AML
BB	109	30PA102-AML
BD	107	30PA104-AML
BE	106	30PA105-AML
BS	117	30PA117-AML
BT	118	30PA118-AML
BV	119	30PA119-AML
BW	120	30PA120-AML

Specify different Key Combinations to acquire different keys, i.e.; AML27ABK2AA21BB and AML27ABK2AA21BE have different keys. AML27ABK2AA21BB and AML27ABK3BC25BB have identical interchangeable keys.
 Example: **AML27ABK2AC28BB**
 Square housing; black bezel and button; .110 x .020 terminals; 2-pole double-throw; silver contacts; 3-position maintained and key code "BB".

CIRCUITRY

2-Position Switches:

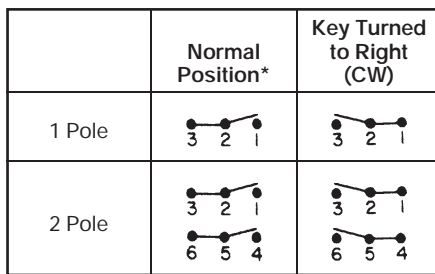

Note: These keys fit the 5-bit keylocks in the Order Guide.

3-Position Switches (Available in 2-pole only.)

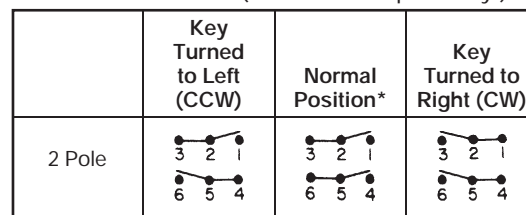

* Circuit remains the same with key in or out.

* Key out in both positions.

** Key out in all three positions.

*** Key out in center and CW positions.

† Key out in center and CCW positions.

†† Key out in CCW only.

Manual Switches

Power Duty Pushbutton

AML31/32 Series

INCANDESCENT, NEON, OR NON-LIGHTED DISPLAY

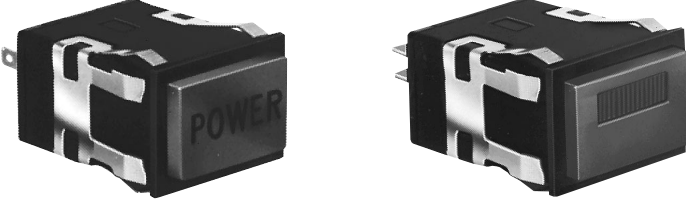

Buttons ordered separately.

CONTACT ARRANGEMENT

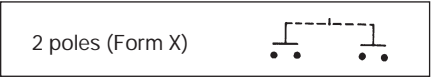

Electrical Data	page 11
Buttons	page 30
Lamps and LEDs	page 46
Accessories	pages 44/45
Mounting Dimensions	page 48

FEATURES

- UL recognized, CSA certified.
- AML31 lamp circuit independent of switch circuit.



*AML31 Series: 2-pole.
*AML32 Series: 2-pole.

AML31 ORDER GUIDE

AML31 accepts one incandescent lamp which can be furnished installed or ordered separately.

AML31 E	B	A	4	AC
Housing Type Standard Bezel: AML31E Rect. Non-Lighted AML31F Rect. 1 Lamp Ckt. Full Guard Bezel: AML31K Rect. Non-Lighted AML31L Rect. 1 Lamp Ckt.	Bezel Color B Black	Incandescent Lamp Type A No Lamp Installed B 6 V Lamp* C 14 V Lamp* E 28 V Lamp*	Terminal Type 4 .187 × .020 (Solder or Quick-Connect)	Circuitry Codes 2-Pole, Single-Throw Normally-Open, Form X: AD AC Alt. Mom. Action Action

* Lamps will be installed per each lamp circuit specified in the Housing Type.

Example: **AML31EBA4AC**

Rectangular pushbutton switch housing, non-lighted; black bezel; .187 × .020 terminals; momentary action; 2-pole, single-throw, normally open, Form X.

Manuals

AML32 ORDER GUIDE

AML32 has neon lamp wired to 125 or 250 VAC resistor.

AML32 F	B	C	7	AC
Housing Type Standard Bezel: AML32F Rect. 1 Neon Lamp Full Guard Bezel: AML32L Rect. 1 Neon Lamp	Bezel Color B Black	Neon Lamp Voltage/Color Red B 125 VAC C 250 VAC Clear K 125 VAC L 250 VAC Green M 125 VAC P 250 VAC	Terminal Type Lamp Circuit 4 .187 × .020 (Solder or Quick-Connect) with isolated lamp circuit 7 .187 × .020 with integral lamp circuit	Circuitry Codes 2-Pole, Single-Throw Normally-Open, Form X: AD AC Alt. Mom. Action Action

Example: **AML32FBC7AC**

Rectangular pushbutton switch housing; black bezel; 250 volt, red neon lamp; .187 × .020 terminals with integral lamp circuit; momentary action; 2-pole, single-throw, normally open, Form X.

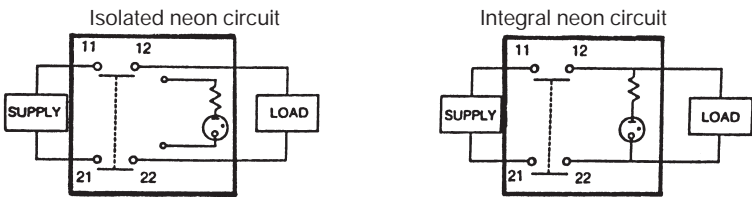

Manual Switches

Power Duty Paddle

INCANDESCENT, NEON, OR NON-LIGHTED DISPLAY

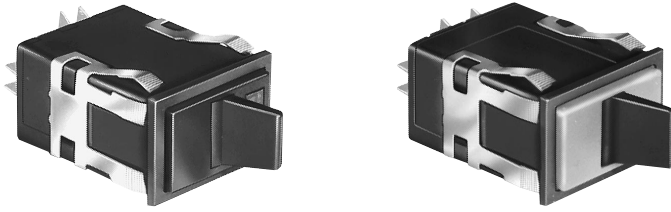

Colored housing covers ordered separately.

Electrical Data	page 11
Paddle Covers	page 35
Lamps	page 46
Mounting Dimensions	page 48

FEATURES

- Toggle type paddle operators permanently installed in rectangular housings.
- 2-position maintained action.
- AML33 lamp circuit independent of switch circuit.
- UL recognized, CSA certified.



*AML33 Series: 2-pole only.
*AML35 Series: 1-pole and 2-pole.

CONTACT ARRANGEMENT

1 or 2 poles: Form A



AML33 ORDER GUIDE

AML33 accepts one incandescent lamp which can be furnished installed or ordered separately.

AML33 E	B	A	4	AA	01
Housing Type	Operator/Bezel Color	Incandescent Lamp Type	Terminal Type	Circuitry Codes	Operating Action
AML33 E Rectangular Non-Lighted AML33 F Rectangular 1 Lamp Ckt.	B Black/Black 	A No Lamp Installed B 6 V Lamp* C 14 V Lamp* E 28 V Lamp*	4 .187 × .020 (Solder or Quick-Connect)	Silver Contacts: AA 1-Pole (One Form A Single-throw, Normally-Open) AC 2-Pole (Two Form A)	 01 Maint. ON Maint. OFF

* Lamps will be installed per each lamp circuit specified in the Housing Type.

AML35 ORDER GUIDE

AML35 has neon lamp wired to 125 or 250 VAC resistor.

AML35 F	B	B	4	AA	01
Housing Type	Operator/Bezel Color	Neon Lamp Voltage	Terminal Type/Lamp Circuit †	Circuitry Codes	Operating Action
AML35 F Rectangular 1 Neon Lamp	B Black/Black 	Red B 125 VAC C 250 VAC Green M 125 VAC P 250 VAC	4 .187 × .020 (Solder or Quick-Connect) With Isolated Lamp Circuit 7 .187 × .020 With Integral Lamp Circuit (Available with 2-Pole devices only)	Silver Contacts: AA (One Form A Single-Throw) Available only with isolated lamp circuit, term. type 4. AC 2-Pole (Two Form A)	 01 Maint. ON Maint. OFF

① The "MICRO SWITCH" identification is shown on this side of the switch housing.

Example: **AML35FBB4AA01**

Rectangular paddle switch housing; black paddle and bezel; 125 VAC neon lamp; .187 × .020 terminals with isolated

lamp circuit; 1-Pole Form A Single-Throw; with circuit ON in one extreme position and OFF in the other (maintained).

Manual Switches

Power Duty Rocker

INCANDESCENT, NEON, OR NON-LIGHTED DISPLAY

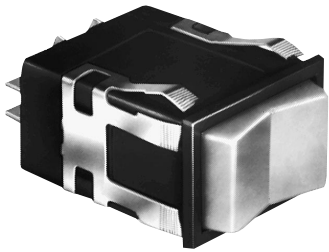

Rocker operators ordered separately.

Electrical Data	page 11
Rockers	page 39
Lamps	page 46
Mounting Dimensions	page 48

FEATURES

- Same circuitry, and electrical rating as power duty paddle switches.
- Neon lamp circuitry can be isolated or integral on 2-pole switches; isolated-only on 1-pole switches (see schematics).
- UL recognized, CSA certified.
- AML34 lamp circuit independent of switch circuit.



AML34 Series: 2-pole only.
AML36 Series: 1-pole and 2-pole.

AML34 ORDER GUIDE

AML34 accepts one incandescent lamp which can be furnished installed or ordered separately.

AML34 E	B	A	4	AA	01
Housing Type	Bezel Color	Incandescent Lamp Type	Terminal Type	Circuitry Codes	Operating Action
AML34 E Rectangular Non. Illum. AML34 F Rectangular 1 Lamp Ckt.	B Black	A No Lamp Installed B 6 V Lamp* C 14 V Lamp* E 28 V Lamp*	4 .187 × .020 (Solder or Quick-Connect)	Silver Contacts: AA 1-Pole (One Form A Single-Throw) AC 2-Pole (Two Form A)	 01 Maint. ON Maint. OFF

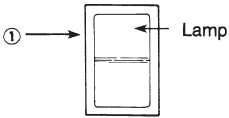

* Lamps will be installed per each lamp circuit specified in the Housing Type.

AML36 ORDER GUIDE

AML36 has neon lamp wired to 125 or 250 VAC resistor.

AML36 F	B	B	4	AA	01
Housing Type	Bezel Color	Neon Lamp Voltage	Terminal Type/ Lamp Circuit	Circuitry Codes	Operating Action
AML36 F Rectangular 1 Neon Lamp	B Black	Red B 125 VAC C 250 VAC Green M 125 VAC P 250 VAC	4 .187 × .020 (Solder or Quick-Connect) With Isolated Lamp Circuit 7 .187 × .020 (Solder or Quick-Connect) With Integral Lamp Circuit	Silver Contacts: AA (One Form A Single-Throw) Not available with terminal type 7 AC 2-Pole (Two Form A)	 01 Maint. ON Maint. OFF

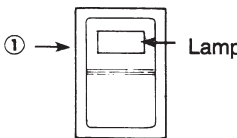

① The "MICRO SWITCH" identification is shown on this side of the switch housing.

Example: **AML36FBB4AA01**
Rectangular rocker switch housing; black bezel; 125 VAC neon lamp; .187 × .020 terminals with isolated lamp circuit; 1-Pole Form A single-throw; with circuit ON in one extreme position and OFF in the other.

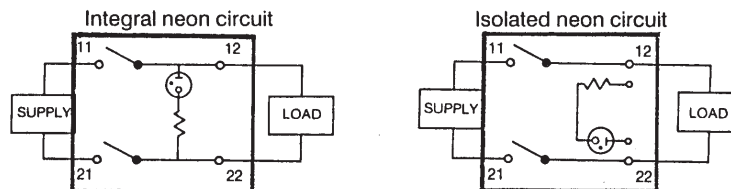

Manuals

Manual Switches

Lighted Indicators

AML41/42 Series

To order lamps see page 46.

FEATURES

- Pushbutton style indicators match display of standard bezel lighted switches. Choice of incandescent or LED illumination.
- Lens style indicators use a special cap-like button which covers the bezel to present a larger display area, without affecting family appearance. Up to 3-lamp split screen capability. Incandescent illumination.



AML41
(Use AML51 push-buttons only. Page 30.)



AML41
(Use AML51-J/-K/-L lens buttons only. Page 30.)

AML41 INCANDESCENT DISPLAY INDICATORS ORDER GUIDE

AML41 C		B	A	2
Housing Type		Bezel Color	Incand. Lamp Type	Terminal Type
Pushbutton Style:	Lens Style:			
AML41 C Square 1 lamp ckt.	AML41 J Rectangular 1 lamp ckt.	B Black	A No lamp installed	2 .110 × .020 (Solder or Quick-Connect)
AML41 D Square 2 lamp ckts.	AML41 K Rectangular 2 lamp ckts.		B 6 V Lamp*	3 .025 × .025 (Printed Circuit or Push-On)
AML41 F Rectangular 1 lamp ckt.	AML41 L Rectangular 3 lamp ckts.		C 14 V Lamp*	
AML41 G Rectangular 2 lamp ckts.			E 28 V Lamp*	

* Lamps will be installed per each lamp circuit specified in the Housing Type.

Examples:

AML41CBA2

Square (pushbutton style) indicator housing with one lamp circuit; black bezel; .110 × .020 termination.

AML41JBA2

Rectangular (lens style) indicator housing with one lamp circuit; black bezel; .110 × .020 termination.



AML42C
(Use AML52-C/-A pushbuttons only. Page 31.)



AML42S

AML42 LED DISPLAY INDICATORS ORDER GUIDE

LEDs are not replaceable.

AML42 S	B	C	2
Housing Type	Bezel Color	LED Color/Voltage	Terminal Type/ Diode Protection
AML42 C Square 1 LED	B Black	Red B V* C 5 V D 10 V E 15 V F 24 V	2 .110 × .020 (Solder or Q.C.)
AML42 S Compact 1 LED	Yellow H V* J 5 V K 10 V L 15 V M 24 V	Green R V* S 5 V T 10 V W 15 V X 24 V	3 .025 × .025 (Printed Circuit or Push-On)
			8 .110 × .020 w/diode to protect LED
			9 .025 × .025 w/diode to protect LED

Example: **AML42SBC2**

Compact indicator with black bezel; 5 volt red LED; .110 × .020 termination.

* See LED application data, page 46, for these devices without current-limiting resistor.

Manual Switches

Solid State LED Annunciators



AML45 Housing

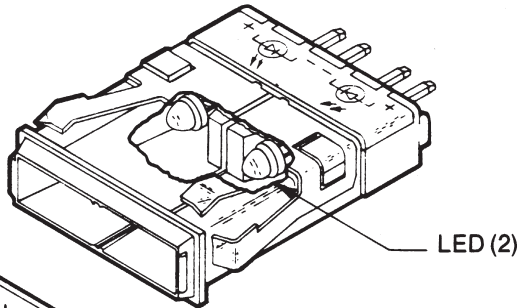

AML59 Cap Assembly

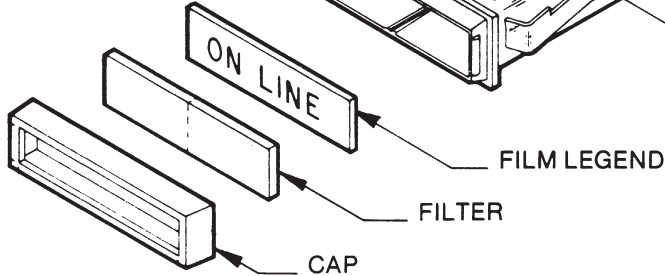

LED (2)

FILM LEGEND

FILTER

CAP

FEATURES

- Messages are backlighted with LED's for long, reliable operating life. Reduces service and maintenance costs.
- Low voltage and current (without inrush), enables direct drive with integrated circuits. Reduces cost of interface components (and installation), and power supply.
- Low operating temperature allows high-density, continuous operation. Minimal heat build-up.
- Inherently rugged. Resists effects of shock and vibration (no filaments to break).
- High density message display. Illuminates up to four legend sectors in color, in a 0.8 x 1.2 inch area.
- Dead front hides legends until illuminated. Non-glare display with no flickering.
- UL recognized.

AML45/59 solid state LED annunciators are a state-of-the-art advancement over traditional back-lighted legend displays which utilize incandescent lamps. The LED light source imparts the benefits of solid state long-life and reliability, with low power requirements. Operating life is measured by years, instead of hours.

The AML45 housing has two high efficiency LED's which illuminate color filters and film legends located in the snap-on AML59 cap assembly. There is a choice of full face one-color and split one-color or two-color displays. Color options are red, green, and yellow.

Film legends offer a choice of negative or positive formats. (Note: human factors engineers generally favor negative annunciator messages, reserving the positive format for use if special attention is necessary, such as "PAPER JAM.")

When unlighted, the legend is hidden (dead front).

NEGATIVE

When illuminated, colored legend appears against a black background.

NEGATIVE

POSITIVE

When illuminated, black legend appears against a colored background.

POSITIVE

This annunciator is totally compatible with other devices in the MICRO SWITCH AML Advanced Manual Line both in front of, and behind the panel. Two of them fit in the same space as a rectangular AML indicators or switch. All terminals exit at AML's standard 1.7-inch depth for convenient, single-level wiring.

Manual Switches

Solid State LED Annunciators

AML45 LED HOUSINGS

LEDs should be specified as the same color if a full or split screen one-color display is desired (RR = red); or different colors for a split screen two-color display (RY = red/yellow). (Baffle plate inside housing prevents light spillage from one LED color section to the other on split screen versions.)

LED colors should match filter colors specified in AML59 cap assembly (see page 28).

Spring clips on sides of the housing hold units securely in panel. For mounting strips of two or more units, AML61 mounting hardware may be used (see page 43).

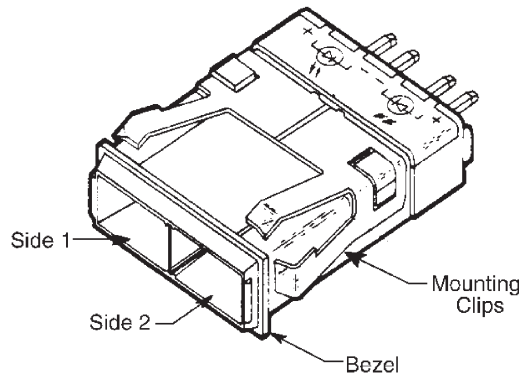

LED APPLICATION INFORMATION

Refer to page 47.

PANEL ORIENTATION

Drawing (above) indicates Side 1 and Side 2 LED locations, with MICRO SWITCH identifications facing UP. Consider this orientation when ordering an AML45S housing with two different LED

colors, such as RG (red/Side 1, green/Side 2). Since LED's are permanently installed, color location is specially important to note when the device is to be terminated in a printed circuit board.

AML45 ORDER GUIDE

AML45 S		W	A	2	RY	
Housing Type		Color of Housing Bezel		Terminal Type	LED Color	
		W	A		Side 1	Side 2
AML45 R 2 LED's (For use with Full Screen)		White	2.4 V	2 .110 × .020 (Solder or Quick-Connect)	R Red	R Red
AML45 S 2 LED's (For use with Split Screen)		Black	5 V	3 .025 × .025 (Printed Circuit)	Y Yellow	Y Yellow
			10 V	8 .110 × .020 with diode protection for LED's	G Green	G Green
			15 V			
			24 V			

* Current draw is 20 mA. "B", "C", "D" and "F" have built-in current limiting resistors.

Example: **AML45SWA2RY**
 Split screen type housing with white bezel, 2.4 V LED's, .110 × .020 termination, red LED in Side 1 and yellow LED in Side 2.

Manual Switches

Solid State Annunciators

SUBPANEL MOUNTING



Order AML45/59 annunciators and AML61 mounting hardware separately.

AML61 mounting hardware may be used for mounting strips of two or more annunciators in pairs in a single cutout. This method is most cost-effective for multi-unit application, since it generally takes less time to make one large hole to accept several units than it does to make a hole for each individual unit. Also, if the front panel is not required for mounting support, it can be made thinner, and easier to cut out, minimizing installed cost.

AML61 strips are factory assembled with metal cans welded together, and mounting brackets welded to the end cans. Refer to page 33 for ordering information.

INSTALLATION

Each rectangular AML61 mounting can will accommodate two annunciators, as shown in the drawing. Panel appearance is enhanced if a spacer .05 in./1.3 mm thick (approx.) is installed between the housings at the terminal end. Specify Catalog Listing 30PA1-AML for a package of 10 spacers.

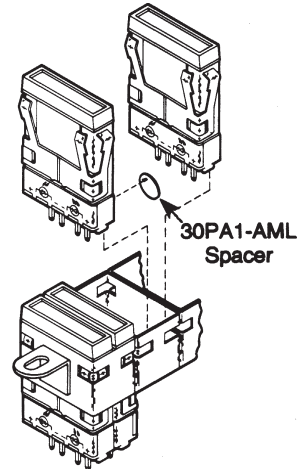

Mounting centers and panel cutout dimensions are shown on page 52. An installation instruction sheet PK8520 is shipped with each order.

PRINTED CIRCUIT BOARD DIMENSIONS

Suggested printed circuit board layout for up to ten AML45 units assembled in an AML61 assembly:

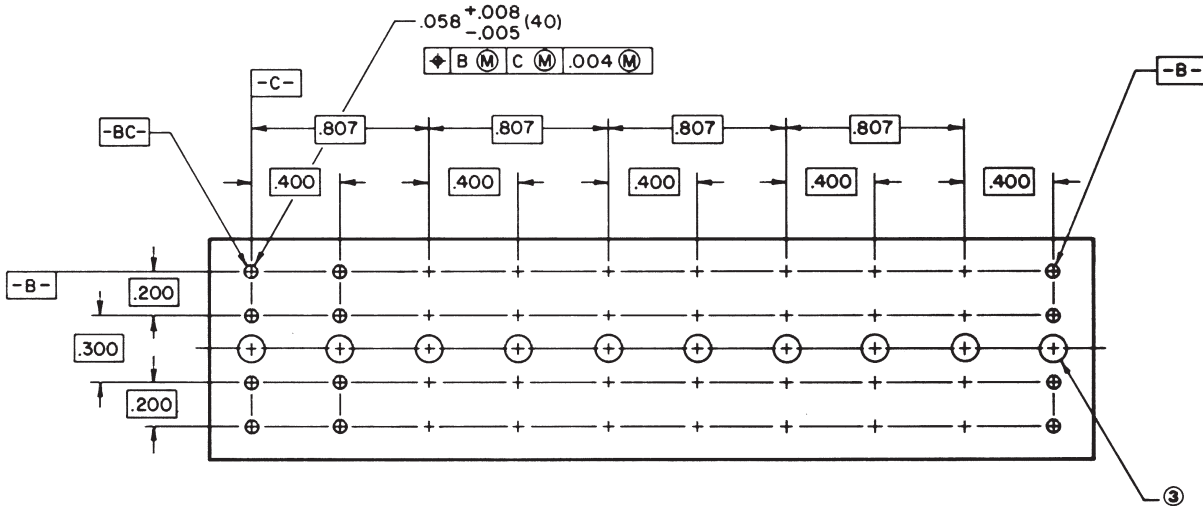

© .125" minimum diameter hole recommended to permit access to annunciator, allowing it to be driven out panel front should replacement become necessary.

Manuals

Maual Switches

Solid State LED Annunciators

AML59 CAP ASSEMBLIES

The cap assembly consists of: black cap, color filter(s), and optional film legend; furnished unassembled. It snaps onto housing, flush with the housing bezel.

Filters, assembled with their matte finish facing the LED's, efficiently diffuse the illumination. They are color-tinted to complement the red, yellow, and green LED's.

NOTE: Cap assembly should not be subjected to the temperature and chemical atmosphere associated with wave soldering. These parts should be installed after soldering and cleanup.

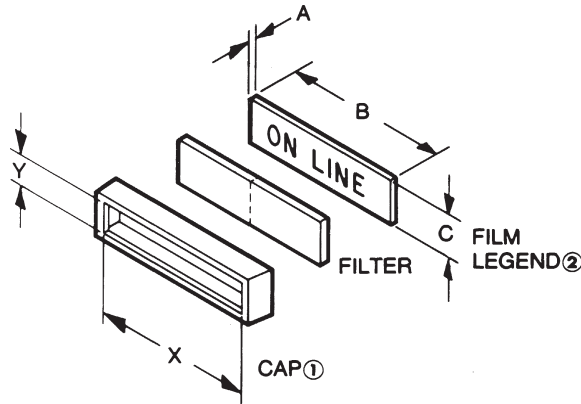

Catalog listings for AML59 cap assemblies are derived from the ordering guide below. The ordering guide for AML45 LED housings is on page 26.

CUSTOM LEGENDS

A 2:1 drawing in black ink is required for satisfactory reproduction of custom film legends. As an alternative, you may submit an office copy of a page from a typographic supplier catalog such as Charpak, Letraset, and Zipatone. MICRO SWITCH can also furnish graphic legends from the "Henry Dreyfus Symbol Source Book." (Custom legends require a one-time start-up charge.)

- ① Viewing area inside cap:
X = 1.04 min.; Y = .272 min.
- ② Customers ordering film legends from commercial photographic or typesetting sources should specify that the film be precision cut, per the following dimensions, to insure proper retention and alignment on the face of the annunciator: A = .007 max.; B = 1.1 ± .010; C = .300 ± .003.

STANDARD LEGENDS

AML59 Legend Sheet (see page 30) provides ordering information for negative and positive standard film legends in the type style (14-point Helvetica condensed bold) shown below. Use separate legend sheet for each AML59 catalog listing and attach it (them) to your purchase order.

ABCDEFGHIJKLMNOPQRSTUVWXYZ
UVWXYZ &?!(:) : ' , . - / # % 1/2
\$0123456789

Approx. .165"

AML59 ORDER GUIDE

Cap Style		Cap Color	Legend Type	Filter Color		
AML59-R		K	10	Full Screen	Split Screen	
R	Full Screen	K	10	R	R	R
		Black	No Legend	Red	Red	Red
S	Split Screen		20	Y	Y	Y
			Negative Film Legend	Yellow	Yellow	Yellow
			21	G	G	G
			Positive Film Legend	Green	Green	Green

Examples:
AML59-RK10R
 Full screen style, black cap, no legend, and red filter.

AML59-SK20RY
 Split screen style, black cap, negative film legend, red and yellow color filters.

AML59 Legend Sheet

Account NO _____

Use this form to describe film legends to be used with AML59 Series Cover Assemblies

Catalog Listing AML59 -	Quantity Ordered
P.O. No.	Line No
Schedule No.	Customer Dwg. No.
S. O. No	Customer Part No.

Customer: _____
Address: _____ (city) _____ (state)

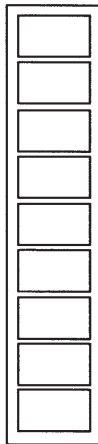
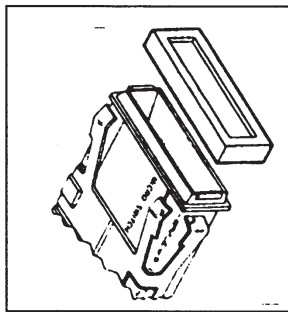

Style "R" (Full Screen)

Special Direction _____

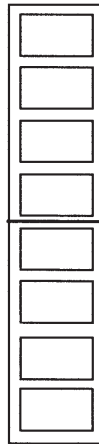
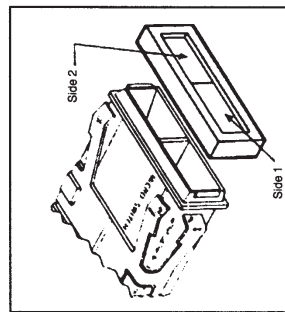

Style "S" (Split Screen)

Special Direction _____

INSTRUCTIONS:

1. Please use black ink to fill in shaded areas.
2. Fill in appropriate catalog listing. - One listing per sheet.
3. Fill in quantity ordered and your order no.
4. Indicate legends desired - do not exceed 9 characters for style "R" or 4 characters on either side of style "S".
5. This completed form must accompany your purchase order

NOTES:

- Legends must be designed to properly assemble to housings, which are to be installed with the MICRO SWITCH logo "up".
- All legends will be centered unless special directions are given.
- Standard legends are 14 pt. helvetica, condensed - Bold. A thru Z and numerals 0 thru 9 are standard.
- Legend Type: - Type "20" **NEGATIVE** - Type "21" **POSITIVE**









Manual Switches

AML51 Series

Buttons/Lens for Switches and Indicators

AML51 PUSHBUTTON ORDER GUIDE (All possible color combinations may not be available.)

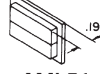
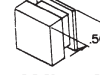
For Incandescent or non-lighted display switches and pushbutton style indicators.

AML51-C	10	R	—
For AML11, 21, 31 switches and AML41 indicators: Pushbutton Style	Display Legend/Type	Full Color or 1st Color Split	2nd Color Split
 AML51-C	Transmitted Color 10 No legend 20 With legend on cap.	R Red Y Yellow G Green B Blue W**** White K*** Black L*** Gray A** Amber	R Red Y Yellow G Green B Blue W**** White K*** Black L*** Gray A** Amber
 AML51-A	Transmitted Color (Clear cap and color insert) 11 No legend 21 With legend on insert		
 AML51-B*	Dead Front (Smoky gray cap and color insert) 30 No legend 40 With legend on insert		
 AML51-F	****Projected Color (White cap and color insert) 50 No legend 60 With legend on cap		
 AML51-H			
 AML51-E*			
 AML51-N*			
 AML51-M*			
 AML51-R*			
For AML41D indicators only:			
 AML51-D			



Example: **AML51-C10R**
 Square full color button; with transmitted color, no legend; red.

** Available with transmitted color and dead front only.
 *** Black and gray not recommended for lighted display.
 † AML51-N buttons not available with Display/Legend Types 10 and 20.
 Note: Dimensions include the .060 in bezel.

* Available with transmitted color (10 or 20) only.
 **** Insert is clear for projected color when "W" is used.

AML51 LENS ORDER GUIDE

(All possible color combinations may not be available.)
 For incandescent display AML41J, K, and L lens style indicators only.

AML51-J	10	R		
Lens style	Display/Legend Type	Full Color or 1st Color Split	2nd Color Split	3rd Color Split
 AML51-J	Transmitted Color 10 No legend 20 With legend	R Red	R Red	R Red
 AML51-K	Transmitted Color (Clear cap and color insert) 11 No legend 21 With legend	Y Yellow	Y Yellow	Y Yellow
 AML51-L	Dead Front (Smoky gray cap and color insert) 30 No legend 40 With legend	G Green	G Green	G Green
	****Projected Color (White cap and color insert) 50 No legend 60 With legend	B Blue	B Blue	B Blue
		W**** White	W**** White	W**** White
		A** Amber	A** Amber	A** Amber

AML51 lens buttons provide added display area by snapping onto and covering the bezel of AML41J, K, and L indicators. They do not fit other indicators or switches.

Example: **AML51-J10R**
 Rectangular lens type button; full color; transmitted color, no legend; red.

HOW TO ORDER BUTTON LEGENDS

When specifying legended buttons, submit a legend order sheet to cover each listing. To insure proper legend orientation, AML housings (when viewed from the panel front) should have the "MICRO SWITCH" identification facing UP on square devices and UP or to the LEFT on rectangular.

Button legend order sheets are shown on the following pages. Reproduce them on your office copier.

Legend Sheet	Form No.
AML51 Pushbuttons	FO-63394
AML51 Lens buttons	FO-63395
AML52 Pushbuttons	FO-63504
AML53 Paddle switch covers	FO-63567
AML55 Paddle switch covers	FO-63565
AML54 Rockers	FO-63566
AML56 Rockers	FO-63564



** Not available with projected color.
 **** Insert is clear for projected color when "W" is used.

Manual Switches

Buttons for Switches and Indicators

AML52 BUTTON ORDER GUIDE (All possible color combinations may not be available.)

For AML12, AML22 (w/o light pipe), AML32, AML42 LED display.

AML52-N	10	R
Button Type	Display/Legend Type	Button Color
<p>For LED Devices AML52-C</p>  <p>AML52-A*</p> 	<p>Transmitted Color</p> <p>10 No Legend</p> <p>20 With Legend</p>	<p>R Red</p> <p>Y Yellow</p> <p>G Green</p> <p>B Blue</p> <p>W White</p> <p>K Black</p> <p>A Amber</p> <p>L Gray</p>
<p>For AML32 Neon Devices AML52-N</p> 		

Examples:

AML52-N10R

Rectangular full screen; for use on neon power switch with transmitted color, no legend; red button.

AML52-C10K

Square full screen; for use with LED device; transmitted color, no legend; black button.

AML 52/57 Pushbutton Legend Sheet/Product Specification for L.E.D. & Neon Button

Page ____ of ____

Account No. _____

Catalog Listing AML52 —	
Customer P.O. No.	Customer Dwg. No.
MICRO SWITCH Sales Order	Line Number
Schedule No.	

Customer: _____

Address: _____

_____ (city) _____ (state)

LEGEND ORDER GUIDE													
Button: Type Orientation	Figure NO	Max Lines			Max Characters								
		5/64	7/64	9/64	13/64	5/16	7/64	9/64	13/64	5/16			
	1	3	2	1	1	1	1	1	7	5	5	3	1
	2	3	2	1	1	1	1	1	7	5	5	3	1
	3	1	1	0	0	0	0	0	12	10	0	0	0
	4	1	1	0	0	0	0	0	12	10	0	0	0
	5	3	2	1	1	1	1	1	7	5	4	3	1
	6	3	2	1	1	1	1	1	7	5	4	3	1

Instructions

1. Fill in appropriate catalog listing - one listing/sheet.
2. Check proper figure #, Type size, type color.
3. Fill in quantity required.
4. Indicate legends desired — Do not exceed maximums shown in legend order guide.

Note

1. For Proper Legend Orientation, AML housings (when viewed from front of panel) should have "MICRO SWITCH" logo oriented "UP" on square devices and "UP" or to the "LEFT" on rectangular devices.
2. Please use black ink in filling out this form to help us process your order.

Standard Legend Placement

1. Transmitted Color — Legend on outer shell (Button)
2. Figures 3 and 4 not applicable for AML57 listings

Modified Gothic lettering (A thru Z), numerals (0 thru 9) and Symbols below available in 5/64, 7/64, 9/64, 13/64 and 5/16.		A3		Modified Gothic	
·	,	:	!	?	'
\$	¢	#	%	o	+
→	↑	↓	←	CR	1/4
					1/3
					2/3
					@
					∞
					&
					*
					()
					/
					-
					±
					÷
					×
					≠
					>
					<

LEGEND ORDER CHART

Customer Part NO	Fig NO	Type Size			Ink Color	Button Qty	Legend Description						
		5/64	7/64	9/64			13/64	5/16	Sequence: 1st Line	2nd Line	3rd Line		

SPECIAL LEGENDS

NOTE: Use this area to show special Legend Locations or Configurations NOT shown above. NON-STANDARD legends will involve additional charges and increased delivery time.

Fig. "A" _____ Fig. "B" _____

Sheet Prepared By: _____ (Signature) _____ (Date)

FO-63604-D

Manual Switches Pushbutton Legend Sheet

AML Pushbutton Legend Sheet/Product Specification

Page of

Account NO 126 - 284

LEGEND ORDER GUIDE

Button: Type Orientation	Figure NO	Max Lines/Area			Max Characters/Line		
		5/64	7/64	9/64	13/64	5/16	5/16
1 A*B PR AREA	1	4*3	3*2	2*1	5*4	5*3	1*1
1 C AREA	2	4*3	3*2	2*1	5*4	5*3	1*1
1 D AREA	3	1*1	1*1	0*0	7*5	5*4	0*0
1 E,H* AREA	4	4*3	3*2	2*1	11*10	9*8	5*3
1 E,H* AREA	5	6*6	4*4	3*3	7*5	5*4	3*1
1 F AREA	6	4*3	3*2	2*1	11*10	9*8	5*3
1 F AREA	7	6*6	4*4	3*3	7*5	5*4	3*1
1 G,N AREA	8	1*1	1*1	0*0	11*10	9*8	0*0
1 M AREA	9	5*0	4*0	3*0	8*0	6*0	3*0

Definitions of Markings

Thru holes to snap into indicator housings
Internal reliefs to snap over switch plunger tabs

Standard Legend Placement -

Use special legends sec. for other placements
1. Transmitted Color - Legend on outer shell (Button)
2. Dead Front - Legend on Insert
3. Projected Color - Legend on outer shell (Button)
4. Transmitted color with clear cap legend on insert

LEGEND ORDER CHART

Customer Part No	Fig No	Type Size		Ink Color		But- ton Qty
		5/64	7/64	9/64	13/64	
						1
						2
						1
						2
						1
						2
						1
						2
						1
						2

FO-86394-K

Catalog Listing
AML51 -
Customer P.O. No. _____ Customer Dwg. No. _____
MICRO SWITCH Sales Order _____ Line Number _____ Schedule No. _____

Customer: _____
Address: _____ (city) _____ (state) _____

Instructions

- Fill in appropriate catalog listing - one listing/sheet.
- Check proper figure #, Type size, Type color.
- Fill in quantity required.
- Indicate legends desired - Do not exceed maximums shown in legend order guide.

Note

- For Proper Legend Orientation, AML housings (when viewed from front of panel) should have "MICRO SWITCH" logo oriented "UP" on square devices and "UP" or to the "LEFT" on rectangular devices.
- Please use black ink in filling out this form to help us process your order.
- * INSERT ONLY ON STYLE A & H BUTTON

Modified Gothic lettering (A thru Z), numerals (0 thru 9) and Symbols below available in 5/64, 7/64, 9/64, 13/64 and 5/16.

A3 Modified Gothic

STANDARD SYMBOLS AVAILABLE												
.	:	;	!	?	'	-	"	/	()	*	&
\$	¢	#	%	o	+	-	±	÷	x	=	≠	>
→	↔	↓	↙	↘	↖	↗	↕	↔	↔	↔	↔	↔

SPECIAL LEGENDS
NOTE: Use this area to show special Legend Locations or Configurations NOT shown to the left. NON-STANDARD legends will involve additional charges and increased delivery time.

Fig. "A" _____ Fig. "B" _____

Sheet prepared by: _____
(Signature) _____
(Date) _____

Manuals



AML Lens Legend Sheet/Product Specification

Account No _____ Page _____ of _____

Catalog Listing
AML51 —
Customer P.O. No. _____ Customer Dwg. No. _____
MICRO SWITCH Sales Order _____ Line Number _____ Schedule No. _____
Customer: _____
Address: _____ (city) _____ (state) _____

LEGEND ORDER GUIDE

Button: Type Orientation	Figure No	Max Lines			Max Characters							
		5/64	7/64	9/64	13/64	5/16	5/16					
AREA 1 J	1	4	3	3	2	2	1	14	11	10	7	3
AREA 1 K	2	4	3	3	2	2	1	6	5	5	3	1
AREA 1 2 3 L	3	4	3	3	2	2	1	4	3	3	2	1
AREA 1 J	4	4	3	3	3	3	2	9	7	6	4	2
AREA 1 2 K	5	3	2	2	2	1	1	8	7	6	4	2
AREA 1 2 3 L	6	2	2	1	1	1	0	8	7	6	4	0

Standard Legend Placement

- Transmitted Color — Legend on outer shell (Button)
- Dead Front - Legend on Insert
- Projected Color - Legend on outer shell (Button)

Instructions

- Fill in appropriate catalog listing - one listing/sheet.
- Check proper figure #, type size, type color.
- Fill in quantity required.
- Indicate legends desired — Do not exceed maximums shown in legend order guide.

Note

- For Proper Legend Orientation, AML housings (when viewed from front of panel) should have "MICRO SWITCH" logo oriented "UP" on square devices and "UP" or to the "LEFT" on rectangular devices.
- Please use black ink in filling out this form to help us process your order.

LEGEND ORDER CHART

Customer Part No	Fig No	Type Size	Ink Color	But ton Qty	Legend Description			
					Sequence: Left-to-Right or Top-to-Bottom	3rd Line	4th Line	
	1				1st Line	2nd Line	3rd Line	4th Line
	2							
	3							
	1							
	2							
	3							
	1							
	2							
	3							

Sheet Prepared By: _____ (Signature)

_____ (Date)

Modified Gothic lettering (A thru Z), numerals (0 thru 9) and Symbols below available in 5/64, 7/64, 9/64, 13/64 and 5/16.

.	,	;	!	?	'	"	-	/	()	*	&
\$	¢	#	%	o	+	-	±	+	x	=	≠	<
→	↑	↓	←	CR	1/4	1/2	3/4	1/3	2/3	@	∞	

A3 Modified Gothic

SPECIAL LEGENDS

NOTE: Use this area to show special Legend Locations or Configurations NOT shown above. NON-STANDARD legends will involve additional charges and increased delivery time.

Fig. "A" _____ Fig. "B" _____

Manual Switches

Covers for Paddle Switches

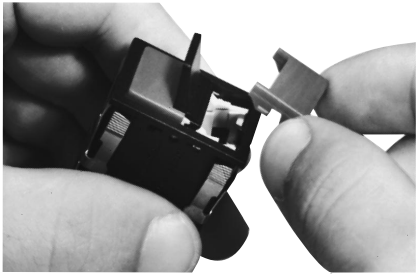

Colored covers simply snap into the top of paddle switch housings.

COLOR DISPLAY OPTIONS

Transmitted color — Color is displayed whether lamp is On or Off. Choice of 1-piece covers (types 10 or 20) or covers with clear cap and colored translucent insert (types 11 or 12).

Projected color — Translucent white cover with transparent colored insert (types 50 or 60). White cover appears colored when illuminated.

Dead front hidden color/hidden legend — Cover appears black with lamp Off. Legend and color appear when illuminated (types 30 or 40).

AML53 PADDLE SWITCH COVER ORDER GUIDE (All possible color combinations may not be available.)

For AML13, AML23, and AML33 incandescent or non-lighted display.

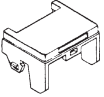
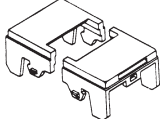
AML53-T	10	R	G																																		
Paddle Switch Cover Type  AML53-E 1/2 Cover  AML53-T Two-Piece Cover	Display/Legend Type Transmitted Color 10 No legend 20 With legend on cap Transmitted Color (Clear cap and color insert) 11 No legend 21 With legend on insert Dead Front (Smoky gray cap and color insert) 30 No legend 40 With legend on insert ***Projected Color (White cap and color insert) 50 No legend 60 With legend on cap	Cover Color <table border="1"> <thead> <tr> <th>1/2 cover, or one side of two-piece cover</th> <th>Other side of two-piece cover (see note)</th> </tr> </thead> <tbody> <tr><td>R</td><td>R</td></tr> <tr><td>Red</td><td>Red</td></tr> <tr><td>Y</td><td>Y</td></tr> <tr><td>Yellow</td><td>Yellow</td></tr> <tr><td>G</td><td>G</td></tr> <tr><td>Green</td><td>Green</td></tr> <tr><td>B</td><td>B</td></tr> <tr><td>Blue</td><td>Blue</td></tr> <tr><td>***W</td><td>***W</td></tr> <tr><td>White</td><td>White</td></tr> <tr><td>K*</td><td>K*</td></tr> <tr><td>Black</td><td>Black</td></tr> <tr><td>L*</td><td>L*</td></tr> <tr><td>Gray</td><td>Gray</td></tr> <tr><td>A**</td><td>A**</td></tr> <tr><td>Amber</td><td>Amber</td></tr> </tbody> </table>		1/2 cover, or one side of two-piece cover	Other side of two-piece cover (see note)	R	R	Red	Red	Y	Y	Yellow	Yellow	G	G	Green	Green	B	B	Blue	Blue	***W	***W	White	White	K*	K*	Black	Black	L*	L*	Gray	Gray	A**	A**	Amber	Amber
1/2 cover, or one side of two-piece cover	Other side of two-piece cover (see note)																																				
R	R																																				
Red	Red																																				
Y	Y																																				
Yellow	Yellow																																				
G	G																																				
Green	Green																																				
B	B																																				
Blue	Blue																																				
***W	***W																																				
White	White																																				
K*	K*																																				
Black	Black																																				
L*	L*																																				
Gray	Gray																																				
A**	A**																																				
Amber	Amber																																				

Note: Only one color code letter is necessary when ordering 1/2 covers.

Example: **AML53-T10RG**
Two-piece cover; with transmitted color, no legend; red and green.

* Not for lighted display.
 ** Not available with projected color.
 *** Insert is clear for projected color when "W" is used.

Manuals

AML55 PADDLE SWITCH COVER ORDER GUIDE (All possible color combinations may not be available.)

For AML35 neon display.

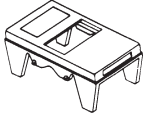
AML55-N	10	R	Y
Paddle Switch Cover Type  AML55-N Full Neon Cover, with colored lens	Display/Legend Type Transmitted Color 10 No Legend 20 With Legend	Lens Color T Clear R Red	Cover Color R Red Y Yellow G Green B Blue W White K Black L Black L Gray

AML55-N covers have a colored lenticular lens window which extends over the neon lamp.

Example: **AML55-N10RY**
Full neon paddle switch cover; with transmitted color, no legend; red lens and yellow cover.

Manual Switches

Covers for Paddle Switches

AML55 PADDLE SWITCH COVER ORDER GUIDE (All possible color combinations may not be available.)

For AML15 and AML25 LED display.

See notes below

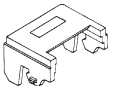
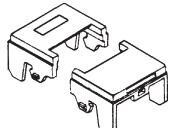
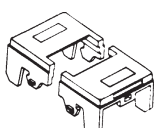
AML55-T	10	Y	R
Paddle Switch Cover Type  AML55-E 1/2 Cover (For one LED)*	Display/Legend Type Transmitted Color 10 No Legend 20 With Legend	Cover Color – See notes below	
 AML55-T Two-Piece Cover (For one LED)		1/2-cover, or LED side of two-piece covers*	Other side of two piece covers
 AML55-H Two-Piece Cover (For two LED's)		R Red Y Yellow G Green B Blue W White K Black L Gray	R Red Y Yellow G Green B Blue W White K Black L Gray

HOW TO ORDER LEGENDS FOR PADDLE SWITCH COVERS

When specifying legended paddle switch covers, submit a legend order sheet to cover each catalog listing. These forms identify the maximum number of lines per area and the maximum characters per line, based on the type size you request.

To insure proper legend orientation, paddle switch housings (when viewed from the panel front) should have the "MICRO SWITCH" identification facing UP or to the LEFT.

Legend order sheets for covers are shown on the following pages. Reproduce them on your office copier or request a pad of them from the 800 number:

Legend Sheet	Form No.
AML53 Covers	FO-63567
AML55 Covers	FO-63565

AML55-E, -T, and -H covers have an open window which allows LED's to be flush with the cover surface.

* Notes:

¹ Only one color code letter is necessary for AML55-E 1/2 covers.

² To order a 1/2-cover without the LED "window," specify an AML53-E listing from the previous page.

Example: **AML55-T10YR**

Two-piece cover; with LED window in one side, transmitted color, no legend; yellow (LED side) and red (non-LED side).

Manual Switches Paddle Operator (Cover) Legend Sheet

Account NO 126 - 284 Catalog Listing **AML53 -** Page of

Customer P.O. No. _____ Customer Dwg. No. _____
 MICRO SWITCH Sales Order _____ Line Number _____ Schedule No. _____

Customer: _____ (city) _____ (state) _____
 Address: _____

- Instructions**
1. Fill in appropriate catalog listing - one listing/sheet.
 2. Check proper figure #, Type size, Type color.
 3. Fill in quantity required.
 4. Indicate legends desired — Do not exceed maximums shown in legend order guide.

- Note**
1. For Proper Legend Orientation, AML housings (when viewed from front of panel) should have "MICRO SWITCH" logo oriented "UP" on square devices and "UP" or to the "LEFT" on rectangular devices.
 2. Please use black ink in filling out this form to help us process your order.

LEGEND ORDER GUIDE

Button: Type Orientation	Figure No	Max Lines/Area			Max Characters/Line						
		5/64	7/64	9/64	13/64	5/16	13/64	5/16			
AREA 1 E	1	2	2	2	1	1	1	1	1	1	1
AREA 1 E	2	2	2	2	1	1	1	1	1	1	1
AREA 1 T	3	2	2	2	1	1	1	1	1	1	1
AREA 2 E	1	7	5	5	4	4	2	2	2	2	2
AREA 2 E	2	7	5	5	4	4	2	2	2	2	2
AREA 2 T	3	7	5	5	4	4	2	2	2	2	2

- Standard Legend Placement - 1. Transmitted Color—Legend on outer shell (Button Use Special Legends Section for other placements.)
 2. Dead Front—Legend on insert
 3. Projected Color - Legend on outer shell (Button)
 4. Transmitted color with color with clear cap legend on insert.
 5. All legends will be centered within the legendable areas

LEGEND ORDER CHART

Customer Part No	Fig No	Type Size			Ink Color		But- ton Qty	Area 1		Area 2	
		5/64	7/64	9/64	13/64	5/16		Black	White	1st Line	2nd Line

FO-65587-F _____ (Signature) _____ (Date)

A3 Modified Gothic

Modified Gothic lettering (A thru Z), numerals (0 thru 9), and Symbols below available in 5/64, 7/64, 9/64, 13/64 and 5/16.

·	,	:	;	!	?	'	—	"	/	()	*	&
\$	¢	#	%	o	+	-	±	÷	x	=	≠	>	<
→	↕	←	CR	1/4	1/2	3/4	1/3	2/3	@	∞			

STANDARD SYMBOLS AVAILABLE

SPECIAL LEGENDS

NOTE: Use this area to show special Legend Locations or Configurations NOT shown above. NON-STANDARD legends will involve additional charges and increased delivery time.

Fig. "A"	Fig. "B"
----------	----------

Manuals

Honeywell

AML Paddle (Cover) Legend Sheet For LED and Neon Style/Product Specification Page of

Account NO 126-284

Catalog Listing **AML55** -

Customer P.O. No.	Customer Dwg. No.	Schedule No.
MICRO SWITCH Sales Order		Line Number

Customer: _____
 Address: _____
 _____ (city) _____ (state)

- Instructions**
1. Fill in appropriate catalog listing - one listing/sheet.
 2. Check proper figure #, Type size, Type color.
 3. Fill in quantity required.
 4. Indicate legends desired — Do not exceed maximums shown in legend order guide.

- Note**
1. For Proper Legend Orientation, AML housings (when viewed from front of panel) should have "MICRO SWITCH" logo oriented "UP" on square devices and "UP" or to the "LEFT" on rectangular devices.
 2. Please use black ink in filling out this form to help us process your order.

Legend Order Guide													
Cover Type Orientation	Figure No	Max Lines/Area			Max Characters/Line			Side 1	Side 2				
		5/64	7/64	9/64	13/64	5/16	5/64			7/64	9/64	13/64	5/16
	1	1	1	1	0	0	7	5	5	0	0		
	2	1	1	1	0	0	7	5	5	0	0		
Side 1: Side 2:	3	1	1	1	0	0	7	5	5	0	0		
Side 1: Side 2:	4	2	2	2	1	1	7	5	5	3	1		
Side 1: Side 2:	5	1	2	2	0	1	7	5	5	0	1		

Standard Legend Placement — Use Special Legends Section for other placements.

1. All Legends will be centered within the legendable areas

LEGEND ORDER CHART

Customer Part No	Fig No	Type Size 5/64 7/64 9/64 13/64 5/16	Ink Color		But ton Qty	Area 1		Area 2	
			Black	White		Sequence: Left-to-Right or Top-to-Bottom	1st Line	2nd Line	1st Line

FO-63565-C

(Signature)

(Date)

SPECIAL LEGENDS

NOTE: Use this area to show special Legend Locations or Configurations NOT shown below. NON-STANDARD legends will involve additional charges and increased delivery time.

Fig. "A"	Fig. "B"
----------	----------

Modified Gothic lettering (A thru Z), numerals (0 thru 9) and Symbols below available in 5/64, 7/64, 9/64, 13/64 and 5/16.
 Modified Gothic

STANDARD SYMBOLS AVAILABLE									
.	:	;	!	?	'	—	"	/	() * &
\$	¢	#	%	o	+	-	±	÷	x = ≠ >
→	↑	↓	←	CR	1/4	1/2	3/4	1/3	2/3 @ ∞

Manual Switches

Rocker Switch Operators

COLOR DISPLAY OPTIONS

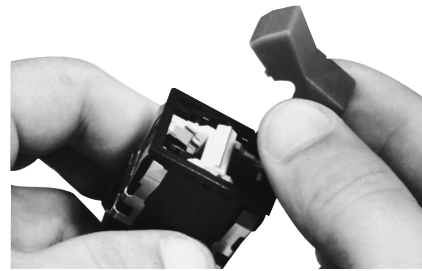

Rocker operators are assembled to the switches by simply snapping them into recesses in the switch operator sockets.

Transmitted color — Color is displayed whether lamp is On or Off. Choice of 1-piece rockers (types 10 or 20) or rockers with clear cap and colored translucent insert (types 11 or 12).

Dead front hidden color/hidden legend — Rocker appears black with lamp Off. Legend and color appear when illuminated (types 30 or 40).

Projected color — Translucent white rocker with transparent colored insert (types 50 or 60). White rocker appears colored when illuminated.

AML54 ROCKER OPERATOR ORDER GUIDE (All possible color combinations may not be available.)

For AML14, AML24, AML34 incandescent or non-lighted display.

AML54-F	10	R	
Rocker Operator Type	Display/Legend Type	Rocker Color – See Note Below	
		Full rocker, 1/2 rocker, or one side of two-piece rockers	Other side of two-piece rockers
AML54-F Full Rocker	Transmitted Color 10 No legend 20 With legend on cap Transmitted Color (Clear cap and color insert) † 11 No legend 21 With legend on insert	R Red Y Yellow G Green B Blue ***W White K* Black L* Gray A** Amber	R Red Y Yellow G Green B Blue ***W White K* Black L* Gray A** Amber
AML54-E 1/2 Rocker	Dead Front † (Smoky gray cap and color insert) 30 No legend 40 With legend on insert		
AML54-T Two-Piece Rocker	***Projected Color † (White cap and color insert) 50 No legend 60 With legend on cap		

NOTE: AML54-F10 and AML54-F20 are one-piece, one-color full rockers. Thus only one color code letter is necessary when ordering. Include a two letter code for all other AML54-E (and AML54-T) catalog listings.

* Not for lighted display.
 ** Not available with projected color or dead front.
 *** Insert is clear for projected color when "W" is used.
 † Not available for use with AML34 power switches.

Example: **AML54-F10R**
 Full rocker; with transmitted color, no legend; red.

Manuals

AML56 ROCKER OPERATOR ORDER GUIDE

For AML36 neon display.

AML56-N	10	R	Y
Rocker Operator Type	Display/Legend Type	Lens Color	Rocker Color
AML56-N Full Rocker with Colored Lens	Transmitted Color 10 No Legend 20 With Legend	T Clear R Red Y Yellow	R Red Y Yellow G Green B Blue W White K Black

AML56-N rockers have a colored lenticular lens window which extends over the neon lamp.

Example: **AML56-N10RY**
 Full rocker; with transmitted color, no legend; yellow rocker and red lens.

Manual Switches

Rocker Switch Operators

AML56 ORDER GUIDE

For AML16 and AML26 LED display.

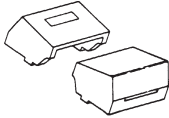
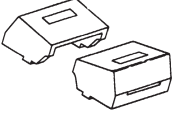
AML56-T	10	R	B
Rocker Operator Type AML56-E  1/2-Rocker* (For one LED)	Display/Legend Type Transmitted Color 10 No Legend 20 With Legend	Rocker Color – See Notes Below	
AML56-T  Two-Piece Rocker (For one LED)		1/2-rocker or LED side of two-piece rockers	Other side of two piece rockers
AML56-H  Two-Piece Rocker (For two LED's)		R Red Y Yellow G Green B Blue W White K Black L Gray	R Red Y Yellow G Green B Blue W White K Black L Gray

Example: **AML56-T10RB**
 Two-piece rocker; with LED window in one side, transmitted color, no legend; red (LED side) and blue (non-LED side).

- * Notes:
- ¹ Only one color code letter is necessary for AML56-E 1/2-rockers. AML56-E, -T, and -H rockers have an open window which allows LEDs to be flush with the rocker surface.
 - ² To order a 1/2-rocker without the LED "window," specify an AML54-E listing from the previous page.

HOW TO ORDER ROCKER LEGENDS

When specifying legended rockers, submit a legend order sheet to cover each catalog listing. These forms identify the maximum number of lines per area and the maximum characters per line, based on the type size you request. To insure proper legend orientation, rocker switch housings (when viewed from the panel front) should have the "MICRO SWITCH" identification facing UP or to the LEFT.

Rocker legend order sheets are shown on the following pages. Reproduce them on your office copier.

Legend Sheet	Form No.
AML54 Rockers	FO-63566
AML56 Rockers	FO-63564

Honeywell

AML Rocker Legend Sheet/Product Specification

Account NO 126-284 Page of

Legend Order Guide														
Button Type Orientation	Figure No	Max Lines/Area			Max Characters/Line			AREA 1	AREA 2	AREA 3				
		5/64	7/64	9/64	13/64	5/16	7/64				9/64	13/64	5/16	
1 E	1	1	1	1	0	0	7	5	5	3	0			
1 E	2	1	1	1	0	0	7	5	5	3	0			
1 H	3	1	1	1	0	0	7	5	5	3	0			
2 N	4	2	2	2	1	1	7	5	5	3	1			
2 T	5	1	2	2	1	1	7	5	5	3	1			

Catalog Listing
AML56 -

Customer P.O. No. _____ Customer Dwg. No. _____

MICRO SWITCH Sales Order _____ Line Number _____ Schedule No. _____

Customer: _____

Address: _____

(city) _____ (state) _____

Instructions

- Fill in appropriate catalog listing - one listing/sheet.
- Check proper figure #, Type size, Type color.
- Fill in quantity required.
- Indicate legends desired — Do not exceed maximums shown in legend order guide.

Note

- For Proper Legend Orientation, AML housings (when viewed from front of panel) should have "MICRO SWITCH" logo oriented "UP" on square devices and "UP" or to the "LEFT" on rectangular devices.
- Please use black ink in filling out this form to help us process your order.

Standard Legend Placement - 1. All legends will be centered within the legendable areas.

Use Special Legends Section for other placements.

SPECIAL LEGENDS

NOTE: Use this area to show special Legend Locations or Configurations NOT shown below. NON-STANDARD legends will involve additional charges and increased delivery time.

Fig. "A" Fig. "B"

Modified Gothic lettering (A thru Z), numerals (0 thru 9) and Symbols below available in 5/64, 7/64, 9/64, 13/64 and 5/16.	A3	Modified Gothic
STANDARD SYMBOLS AVAILABLE		
. , ; ! ? ' _ " / () * &		
\$ ¢ # % ° + - ± × ÷ ≠ > <		
→ ↑ ← ↓	Cr	1/4 1/2 3/4 1/3 2/3 @ ∞

LEGEND ORDER CHART										
Customer Part No	Fig No	Type Size		Ink Color		But- ton Qty	Area 1		Area 2	
		5/64	7/64	9/64	13/64		5/16	Black		White
							1st Line	2nd Line	1st Line	2nd Line

FO-89664-E _____ (Signature) _____ (Date)

Manual Switches Mounting Hardware

FOR STRIP AND MATRIX MOUNT ASSEMBLIES







FEATURES

- Enables subpanel mounting of devices in factory assembled metal cans which are welded together in strips or matrices. Assures accurate alignment and enables pre-wiring.
- L-shaped mounting brackets conform to various panel thicknesses, using spacers.
- Simplifies panel fabrication, since only one large cutout is required.
- Facilitates printed circuit board mounting. Operating force is transmitted to mounting hardware, rather than P.C. board.
- For custom matrices contact the MICRO SWITCH Application Center.
- Mounting dimensions page 52.

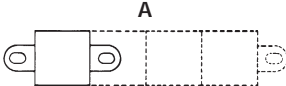
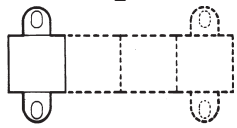
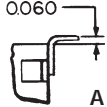
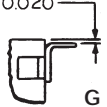
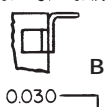
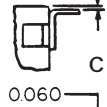
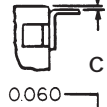
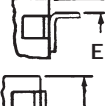
AML61 MOUNTING HARDWARE ORDER GUIDE

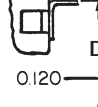
(For standard strip mount assemblies)

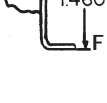
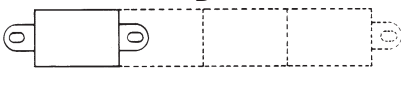
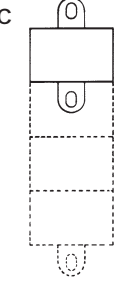
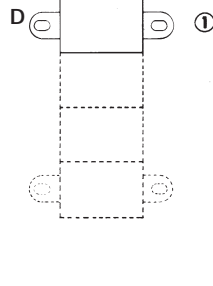
AML61 B	A	5	A
Type	Mounting Bracket Orientation	Number of Cans	Mounting Bracket Location
<p>Square cans:</p> <p>AML61 B (Plain finish)</p> <p>AML61 J (Black finish)</p>	<p>A</p>  <p>E</p> 	<p>1</p> <p>2</p> <p>3</p> <p>4</p> <p>5</p> <p>6</p> <p>7</p> <p>8</p> <p>9*</p> <p>10*</p> <p>11*</p> <p>12*</p> <p>*A, C, D & E orientation only.</p>	 <p>A</p> <p>BRACKET FLUSH TO TOP OF CAN</p>  <p>G</p>  <p>B</p>  <p>C</p>  <p>D</p>  <p>E</p>  <p>F</p>  <p>K</p>  <p>L</p>  <p>P</p>  <p>T</p> <p>U NO BRACKETS</p>
<p>Rect. cans:</p> <p>AML61 E (Plain finish)</p> <p>AML61 K (Black finish)</p>	<p>B</p>  <p>C</p>  <p>D</p>  <p>1</p>		

Manuals

① To order one rectangular can with mounting brackets on short sides, specify AML61EB1___ or AML61KB1___.

Example: AML61EC5A
Five rectangular cans, plain finish (unpainted), long sides abutting; type **A** mounting brackets on long sides, located flush with switch or indicator bezel. (Type **T** bracket brings top of annunciator bezel flush with top of .160 in./4,1 mm panel.)

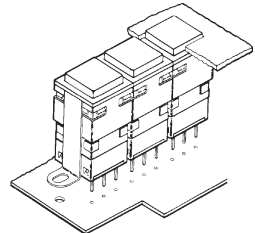

This strip has Type F brackets for P.C. board mounting.

NON-STANDARD ASSEMBLIES
Use the order form on the following page to specify non-standard AML61 strip or matrix assemblies. You may reproduce it on your office copier, or order pads from the 800 number. Request FO-63558.

Manual Switches

Barriers/Panel Seal Accessories

AML71 BARRIERS

When mounting an individual unit, an end barrier is attached to each side of the housing. The center barrier is used in a slot mount array.

FEATURES

- Barriers separate individually mounted switches and indicators — help prevent inadvertent actuation of two pushbutton switches with a single push.
- Front of panel mounting simplifies installation.

AML71 BARRIER ORDER GUIDE (See notes)

Barriers shown in order guide are black.

Barrier Length	Type	Catalog Listing
Short (For use with square devices and short side of rectangular devices.)	Center	AML71SCB
	End	AML71SEB
Long (For use with long side of rectangular devices.)	Center	AML71LCB
	End	AML71LEB

Notes:

Not for use with AML61 mounting hardware or any full guard bezel products.
Not for use with AML41J, K, or L lens type indicators; or AML45 annunciators.

FEATURES

- AML75 panel seals fit pushbutton switches and indicators.
- Provides protection from contamination from accidental beverage spills, dust, and dirt.
- Easy to install, without tools
- No effect on display color, light intensity, or legend quality.
- Replace seal or change lamps without removing switch from panel.
- For .19-inch standard height square or rectangular pushbuttons.
- Mounting dimensions page 53.

The design complements AML's functional appearance, creating a pleasing framed effect around the button. It consists of a matte black plastic base which press-fits between the panel and switch bezel, and a transparent flexible seal which snaps into the base. PK 8521, shipped with each order, provides installation instructions.

Button colors and legends can be viewed without distortion whether lighted or unlighted. Seals can be conveniently replaced or removed for relamping, without removing the switch from panel.

Operating temperature range is 32° to 131°F (0° to 55°C).

AML75 PANEL SEAL ORDER GUIDE

Description	For Use With:		
	Square .19" high pushbuttons	Rectangular .19" high pushbuttons	Rockers
Base & Seal	AML75ABC	AML75BBC	AML75RBC

Notes:

Multiple units should not be mounted in a single slot, since this would create an unsealed space between each unit. AML75 seals are not for use with barriers,

full guard bezels, AML61 mounting hardware, AML45 annunciators, or AML41J, K, or L lens type indicators.

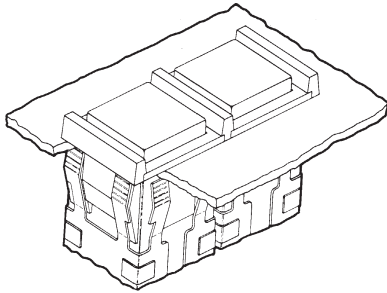

Drawing shows two switches, slot mounted. From left to right: one center barrier, a second switch, plus another end barrier to complete the arrangement.

AML75 PANEL SEAL

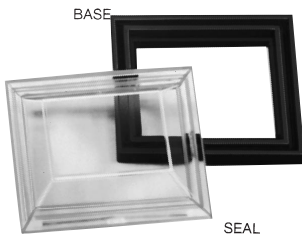
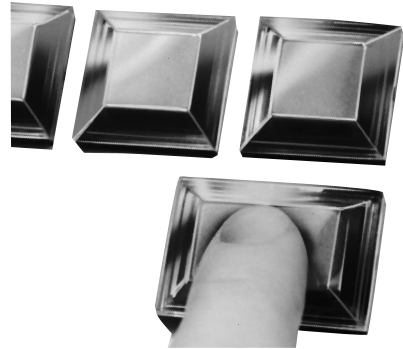

MATERIAL
Base: Polypropylene
Cap: Polyvinyl Chloride

Manual Switches

Switch Guard/Panel Plugs, Dummy Housings

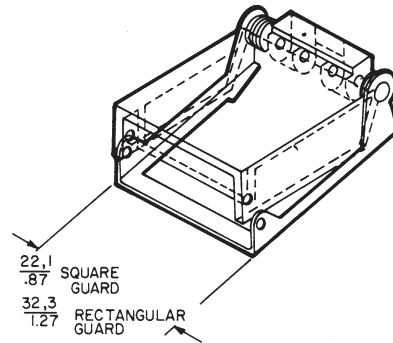
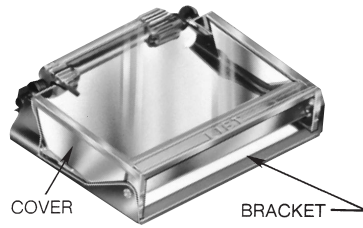

FEATURES

- Button cannot be operated when switch guard cover is closed, preventing accidental operation
- Wire lock-down feature further prevents unintentional actuation of the switch.
- Lamps can be replaced with the switch guard attached, without special tools, saving maintenance time
- Can be used with alternate or momentary action square or rectangular .19 inch standard height AML buttons
- Shock resistant construction, for long, maintenance-free life

AML76 switch guard protects square and rectangular .19-inch standard height pushbuttons from inadvertent actuation. It is for use with standard bezel type switches only.

See page 53 for mounting dimensions.

The switch guard cover is clear, polycarbonate thermoplastic through which the button is easily visible. The word "lift" is molded onto the top front edge of the guard. The bracket is bright-finished stainless steel.

The switch guard may be assembled to the AML pushbutton before the switch is installed in a panel. Or, the guard can be assembled to a pushbutton already mounted in a panel, providing the wiring is sufficiently slack to raise the switch bezel above the panel; and if there is sufficient clearance with adjacent units. PK 8522 contains installation instructions and is shipped with each order.

AML switch guards may be mounted in horizontal or vertical matrices. A wire lock-down feature, using .020-inch diameter locking wire, may be used as an additional protection.

SWITCH GUARD ORDER GUIDE

Guard Type*	Catalog Listing
Square	AML76C10T01P
Rectangular	AML76F10T01P

* The word "LIFT" is molded into the cover. If other languages are desired contact the 800 number.

Note: Switch guard is not designed for use with AML61 mounting hardware, AML71 barriers, or full guard bezel switches.

CONNECTOR BLOCK



AML79CC

This connector block can be used with square 1 and 2 pole AML21 and AML22 switches with .110 x .020 terminals to enable plug-in wiring.

AML78 PANEL PLUGS

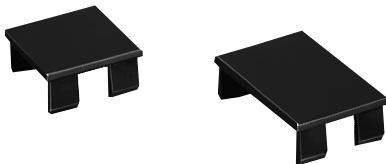

Plastic panel plugs (shown above) enable the user to provide for future needs by punching extra panel holes. Finished in matte black, they are the same height as the standard AML bezel when snapped in place from the panel front.

Panel plugs are only for use in individual holes or with AML61 mounting hardware in multi-station strips. (Use dummy housings in strip cutouts without AML61 mounting hardware.)

PANEL PLUG ORDER GUIDE

Plug Type	Catalog Listing
Square	AML78CB
Rectangular	AML78FB

AML78 DUMMY HOUSINGS

Dummy housings can be used to provide for expansion needs in strip cutouts without AML61 mounting hardware. They have mounting clips, but there is no provision for switching or illumination.

DUMMY HOUSING ORDER GUIDE

Dummy Housing Type*	Catalog Listing
Rectangular (Pushbutton style)	AML78F100
Rectangular (Lens indicator style)	AML78J100

* Order AML51 Buttons/lenses for use with dummy housings.

Manual Switches

Lamps, Soldering Recommendations, Receptacles

AML91 LAMP ORDER GUIDE

Lamp Type	Industry Lamp No.	Voltage	Catalog Listing
Incandescent T-1-3/4 wedge base	86	6.3	AML91LA86
	73	14.0	AML91LA73
	85	28.0	AML91LA85

LAMP DATA

The following data was compiled from manufacturer's specifications, for reference only.

INCANDESCENT LAMPS

Industry Lamp No.	Volts	Amps	Watts	MSCP	Life A/C Volts
86	6.3	.200	1.25	.49	20,000 hours
	5.5	.185	1.12	.246	106,200 hours
	5.0	.177	.89	.185	290,000 hours
73	14.0	.080	1.12	.30	15,000 hours
	12.0	.077	1.00	.23	36,450 hours
85	28.0	.04	1.12	.30	7,000 hours
	24.0	.037	.89	.177	41,860 hours

Neon Lamps

25,000 hours (half life)

INTEGRAL LEDs

LEDs Furnished Permanently Installed in These Products	V _f	I _f	V _{PD}	Peak Inverse Voltage	
				w/o Diode Protection	w/Diode Protection
AML12, 15, 16, 22, 25, 26, 42	2.4 V	20 mA	.7 V	5 V	34 V
AML45	2.4 V	20 mA	.7 V	4 V	33 V

100,000 hours (half life).

AML92 SERIES LEDs



For use with these AML switches and indicators equipped with lamp sockets:
Pushbutton switches: AML11 (Square Only)*, AML21 (rectangular and square), and AML31.

Paddle switches: AML31/23/33

Rocker switches: AML14/24/34

Indicators: AML41

* Rectangular solid state with one or two lamp circuits cannot be used with LED catalog listings ending in "L".

AML92 ORDER GUIDE

LED Color	Quad Chip	Six Chip
Red	AML92ERY	AML92ERL
Green	AML92EGY	AML92EGL
Yellow	AML92EYY	AML92EYL
White	—	AML92EWL**

** For use with white or yellow buttons.

OPERATING CHARACTERISTICS

Type	V _f Fwd. Voltage (typ.)				I _f Fwd. Current	V _R Rev. Voltage
	Yellow	Green	Red	White		
Quad Chip	8.6	8.6	7.8	—	15 mA	16 V
Six Chip	4 V	4 V	4 V	4 V	50 mA	5.6 V

TEMPERATURE RANGE

(Quad Chip or Six Chip)

Operating: -20 to 60°C (-4 to 140°F)

Storage: -30 to 100°C (-22 to 212°F)

SOLDERING RECOMMENDATIONS

All terminals are solder plated. Proper soldering and cleaning procedures must be followed to maintain the reliability of AML products during installation. An instruction sheet which outlines these procedures is included with AML shipments. You may also obtain a copy from your MICRO SWITCH Sales Office. Request PK 8518.

As a general guide, the following information may be used:

Use a 280°C (538°F) solder iron tip, up to 6 seconds duration, with a 60-40 rosin core solder. This allows the terminal to heat quickly on the exterior of the housing only, and greatly reduces the chance of flux migrating inside the housing.

LED APPLICATION INFORMATION

For those devices without internal current limiting resistors, suitable external control of the LED current must be provided. It is recommended that a minimum of 5 VDC open circuit voltage with an appropriate series resistance be used to drive LED devices. This minimizes the effect of temperature (current variation) on forward voltage of the LED.

Resistor values can be determined by supply voltage or current for LED:

$$R_s = \frac{E - V_f}{I_f}$$

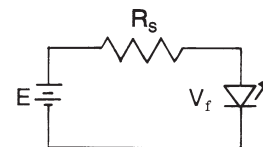

WHERE: R_s = Series Resistance

E = Supply Voltage

V_f = Forward Voltage of LED

I_f = Circuit Current

If a diode is added in series for reverse polarity protection then:

$$R_s = \frac{E - V_f - V_{PD}}{I_f}$$

WHERE: V_{PD} Forward Voltage of Protection Diode

Mounting Dimensions (For Reference Only)

**AML11/12 and 21/22 SWITCHES
AML41C/D and AML42C INDICATORS**

Note: Top of full guard bezel housing .19/5,0 from panel.

PUSHBUTTONS

For terminal locations, see page 49.

AML27 SWITCHES

KEYLOCK

For terminal locations, see page 50.

AML14/16 and AML24/26 SWITCHES

ROCKERS

For terminal locations, see page 49/50.

AML13/15 and 23/25 SWITCHES

PADDLES

LED Location Same as Rocker

For terminal locations, see page 49/50.

**AML41 INDICATOR
LENS STYLE**

For terminal locations, see page 50.

**AML42 INDICATOR
MINIATURE**

NOTE
1 Dimensions are mm or mm/IN

TERMINAL TYPES

Solder Hole will accept two #22 AWG Stranded Conductor (per NEMA publication DC-2 1976)

Manuals

Manual Switches

Mounting Dimensions (For Reference Only)

AML Series

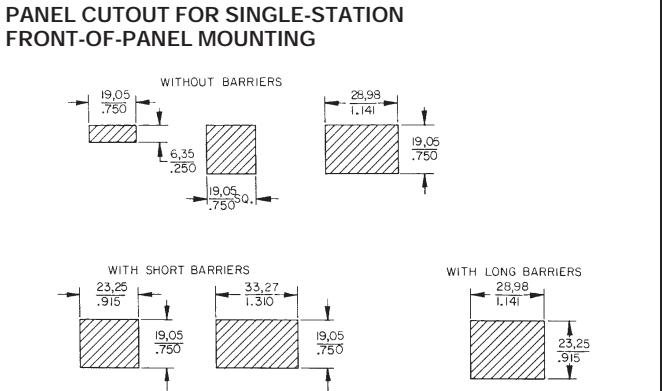
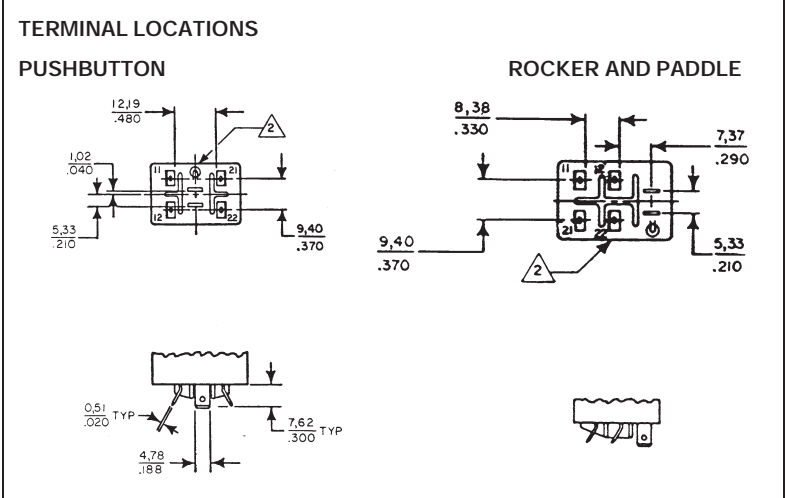
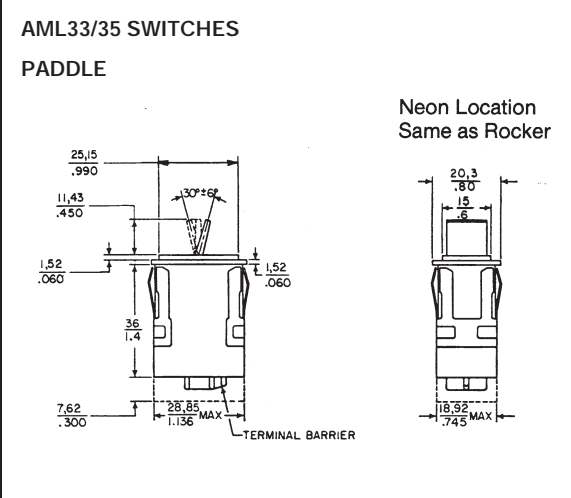
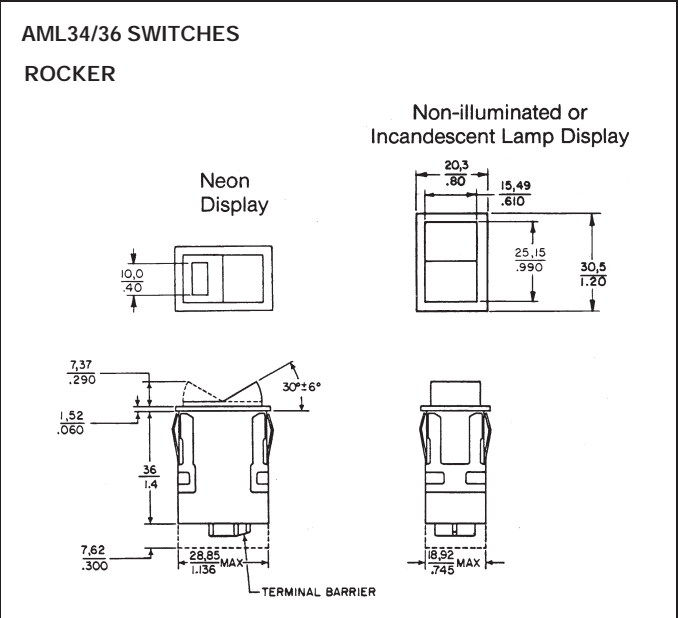
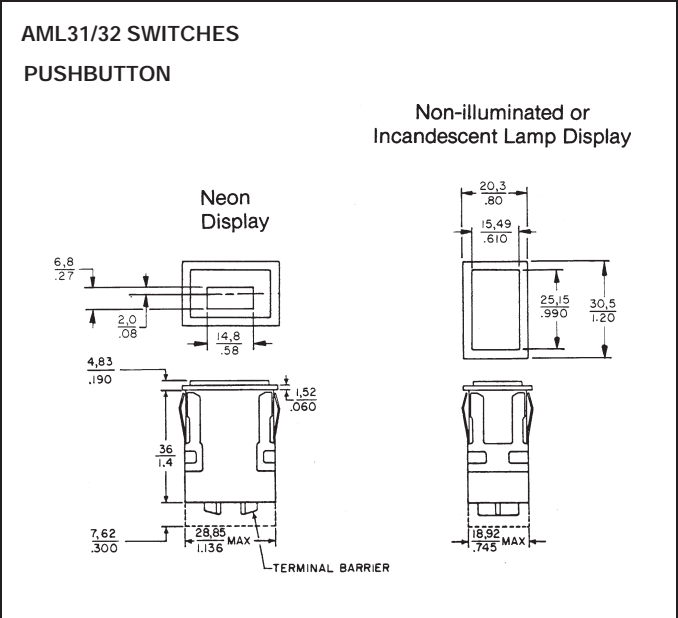

Recommended panel thickness: .060-.187/1,52-4,75

NOTES
 1 Dimensions are mm or mm/IN
 IN
 Manufacturers logo on this side of housing
 Solder Hole Will Accept One #14 AWG Stranded Conductor
 (Per NEMA Publication DC-2 1976)

PANEL PUNCH FOR AML SERIES
 A panel punch is manufactured by Greenlee-Textron Tool Co.,
 Rockford, IL (815-926-3011).

Manual Switches

Mounting Dimensions (For Reference Only)

AML Series

TERMINAL LOCATIONS FOR AML10 SWITCHES

PUSHBUTTONS

Solder and Quick-Connect

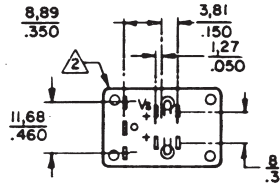
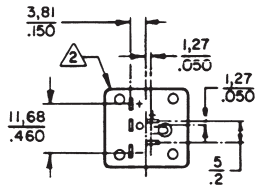

Printed Circuit

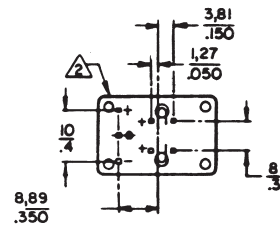
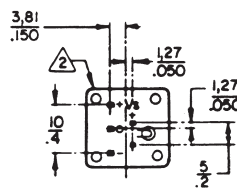

Illuminated devices shown (non-illuminated devices do not have lamp terminals).

ROCKERS AND PADDLES

Solder and Quick-Connect

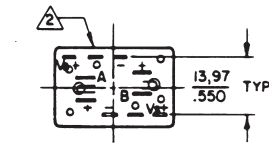
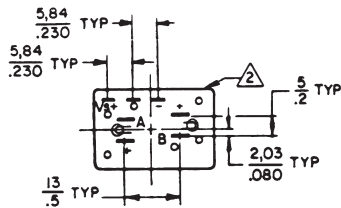

Printed Circuit

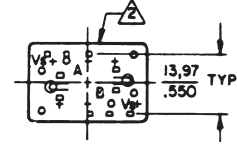
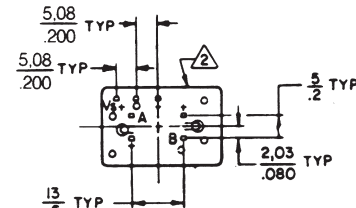

One Integrated Circuit

Two Integrated Circuits

One Integrated Circuit

Two Integrated Circuits

Illuminated devices shown (non-illuminated devices do not have lamp terminals)

TERMINAL LOCATIONS FOR AML41 INDICATORS

Solder and Quick-Connect

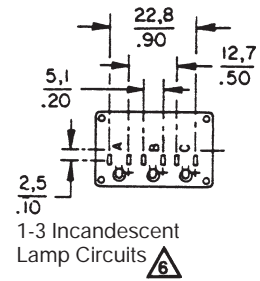
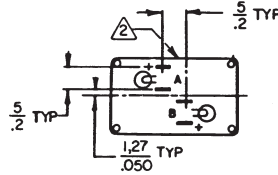
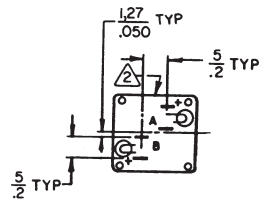
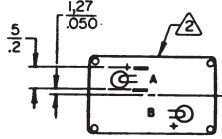
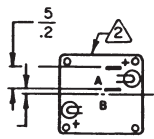

1 Incandescent Lamp Circuit

1 Incandescent Lamp Circuit

2 Incandescent Lamp Circuits

2 Incandescent Lamp Circuits

1-3 Incandescent Lamp Circuits

Printed Circuit

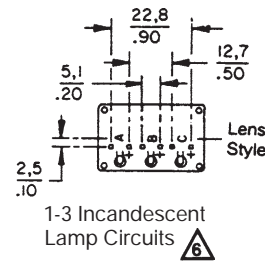
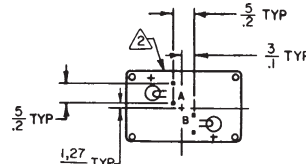
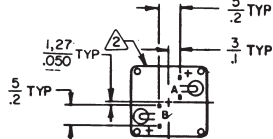
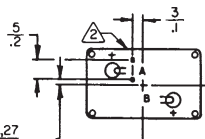
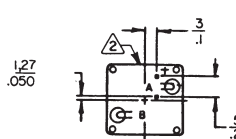

1 Incandescent Lamp Circuit

1 Incandescent Lamp Circuit

2 Incandescent Lamp Circuits

2 Incandescent Lamp Circuits

1-3 Incandescent Lamp Circuits

TERMINAL LOCATIONS FOR AML42 INDICATORS

Solder and Quick-Connect

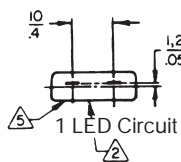
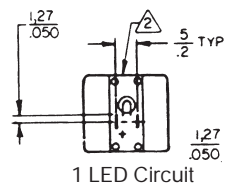

Printed Circuit

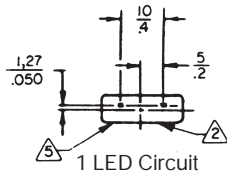
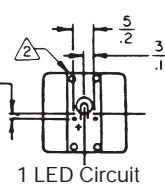

NOTE

1 Dimensions are $\frac{\text{MM}}{\text{IN}}$

2 Manufacturer's logo on this side of housing

4 - Lamp terminals are not provided for non-illuminated devices

5 positive terminal ident. (+) marked this side of housing

6 1 - lamp termination identified by "B".
2 - lamp termination identified by "A" and "C".

Manuals

Manual Switches

Mounting Dimensions (For Reference Only)

AML Series

TERMINAL LOCATIONS FOR AML20 SWITCHES

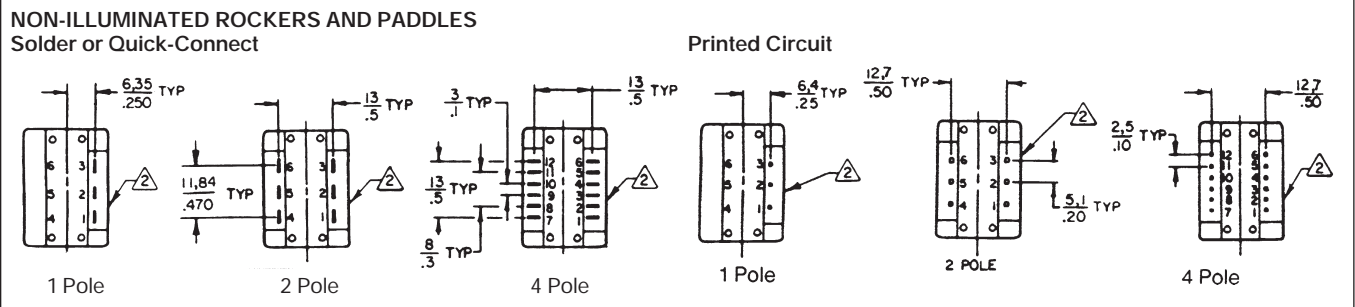
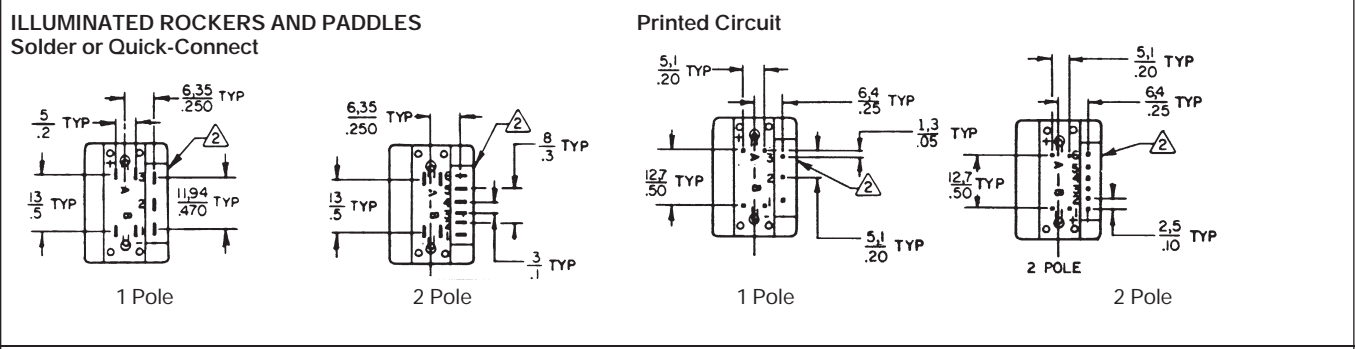
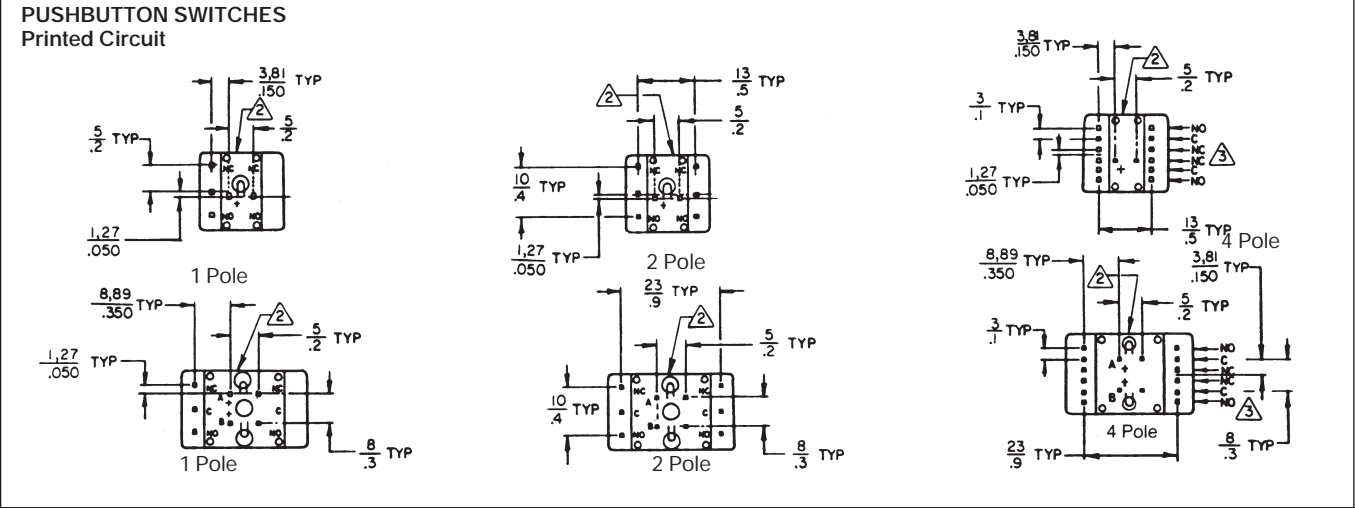
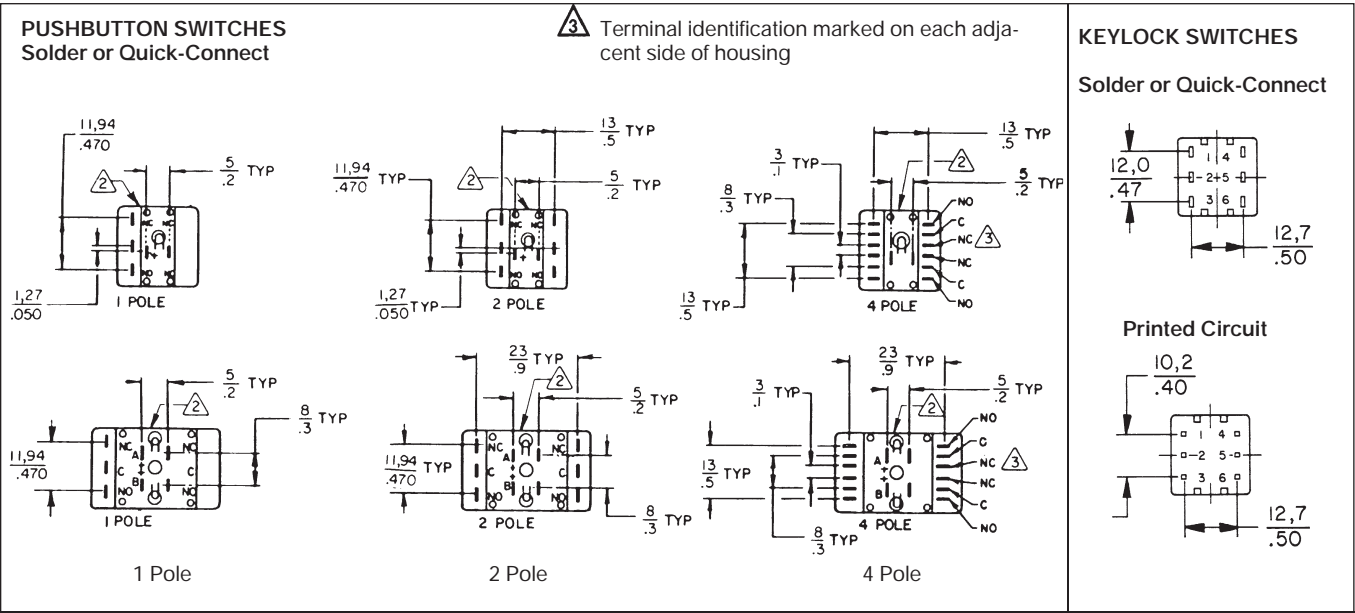

Manual Switches

Mounting Dimensions (For Reference Only)

AML Series

ANNUNCIATORS

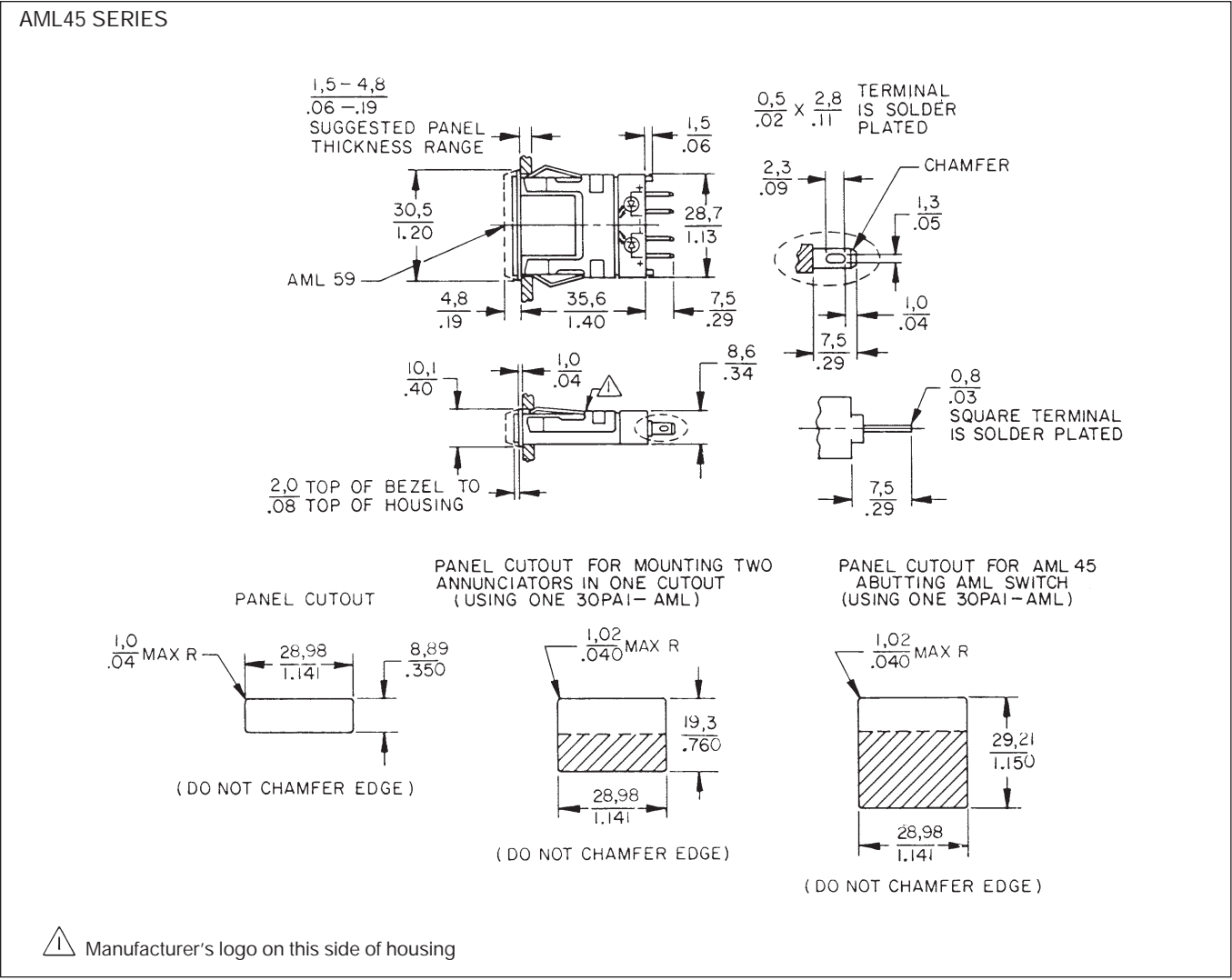

Manuals

For panel punch manufacturer, see page 48.

Manual Switches

Mounting Dimensions (For Reference Only)

MULTI-STATION FRONT-PANEL MOUNTING

Panel cutouts (See page 48 for panel punch manufacturer.)

Square Switches & Indicators	Rect. Switches & Indicators	Annunciator
(.8) (No. of units) — .045*	(1.20) (No. of units) — .045*	(.40) (No. of units) — .045*
(20,3) (No. of units) — 1,14*	(30,5) (No. of units) — 1,14*	(10,1) (No. of units) — 1,14*

For each barrier, add .053/1,35

* Note: If barriers are used, do not subtract .045 in./1,14 mm from the panel cutout formula. (.045 in./1,14mm is the allowance for the width of the bezel.)

AML61 MULTI-STATION SUBPANEL MOUNTING

Panel cutouts for AML61

Mounting Bracket Orientation	Width	Length
A*	in. .810 mm 20,57	(.810)(No. of units)
B	in. .810 mm 20,57	(1.210)(No. of units)
C or D*	in. 1.210 mm 27,94	(.810)(No. of units)

* More than two cans with mounting brackets required for strips of more than 10 units.

AML61 MOUNTING CENTERS

Mounting Bracket Orientation		Mounting Centers/Number of Cans											
		1	2	3	4	5	6	7	8	9	10	11	12
"A" or "C"	in.	1.285	2.095	2.905	3.715	4.525	5.335	6.145	6.955	7.765	8.575	9.385	10.195
	mm	32,64	53,21	73,79	94,36	114,94	135,51	156,08	176,66	197,23	217,81	238,38	258,95
"B"	in.	1.685	2.895	4.105	5.315	6.525	7.735	8.945	10.155				
	mm	42,80	73,53	104,27	135,00	165,74	196,48	227,20	257,94				
"D" or "E"	in.	on C _L	.807	1.614	2.421	3.228	4.035	4.842	5.649	6.456	7.263	8.070	8.877
	mm	on C _L	20,50	41,00	61,49	81,99	102,49	122,99	143,48	163,98	184,48	204,98	225,48

Tolerance = ±.015

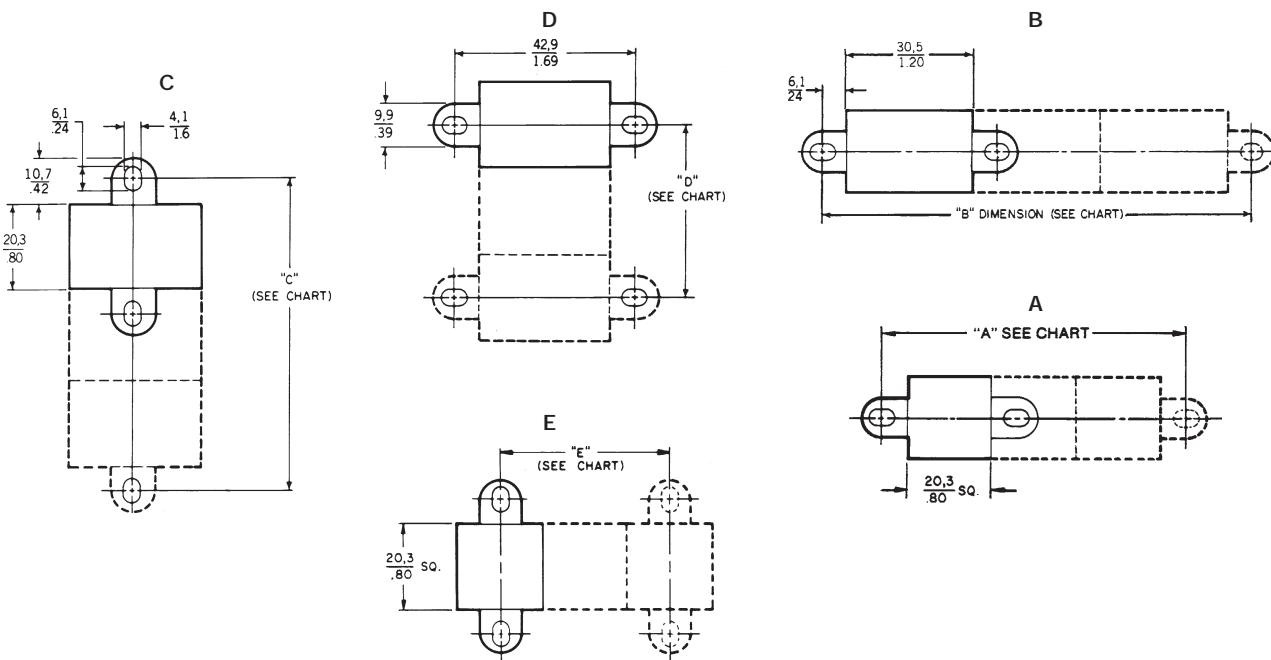

Manual Switches

Mounting Dimensions (For Reference Only)

AML75 PANEL SEAL ACCESSORY

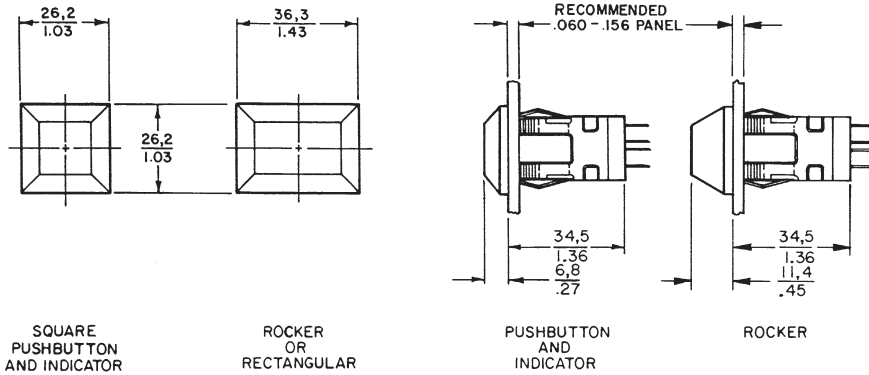

Panel cutouts

Multiple panel sealed units should not be mounted together in a single elongated slot, since this would create an unsealed space between each unit.

Side-by-side mounting can be achieved, per the center-to-center dimensions shown in the drawing. (Dotted lines indicate the seal bases which are abutting at front of panel.)

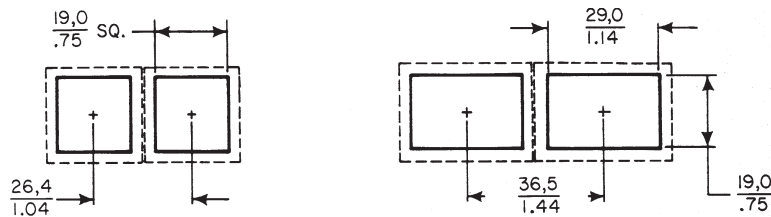

NOTE: Suggested cutout dimensions are based on an .125"/3,18 mm panel thickness. Individual preferences for inpanel fit

may require measurement of assemblies before panels are cut.

AML75 seals are not designed for use with the AML61 mounting system.

AML76 SWITCH GUARD ACCESSORY

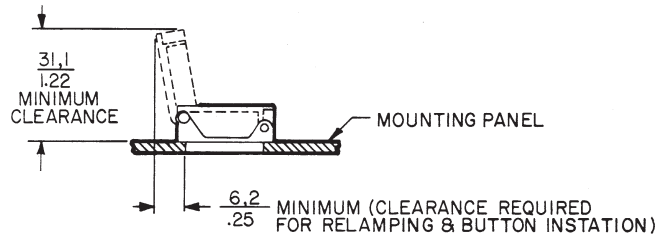
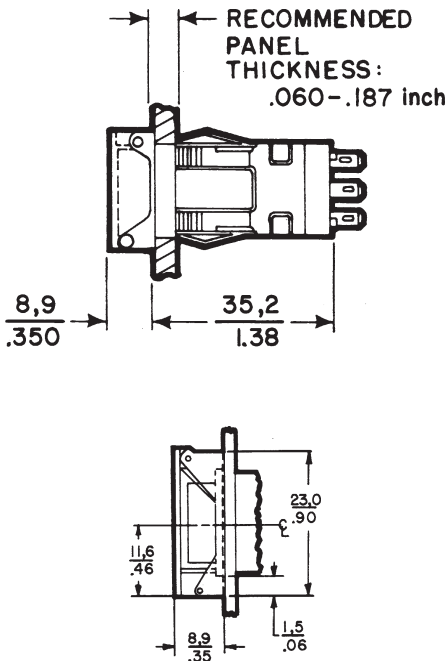

PANEL CUTOUTS

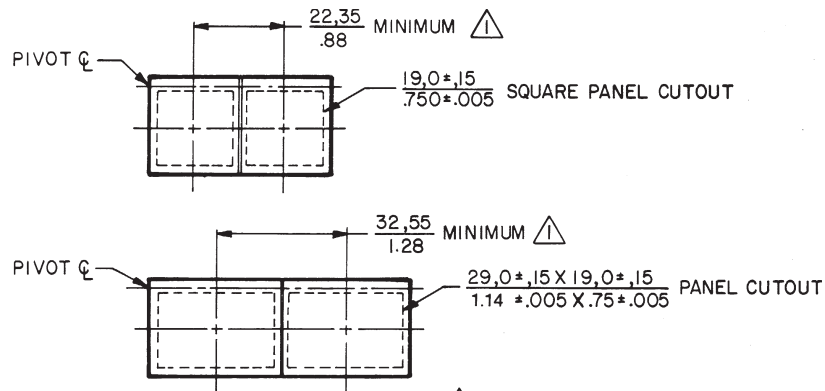

△ MINIMUM DIMENSION ALLOWED FOR MOUNTING GUARDS SIDE BY SIDE

Manuals