

Lighted Pushbutton Switch (Square) Ultra Bright LED Type A3S

Pushbutton Switch Series with Square 40-mm Body.

New models added with Ultra LEDs.

- New models with ultra bright LEDs added to single-screen models.
- Previous models not changed.
Line up of models in seven colors (the previous red, orange, green, and white models, and the new yellow, blue, and pure white models).

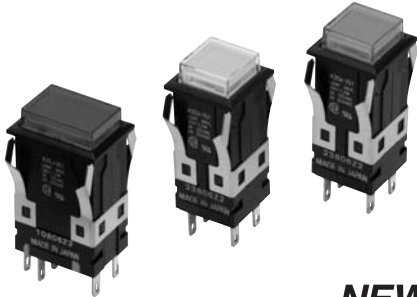

NEW

 Refer to *Safety Precautions for All Pushbutton Switches/Indicators* and *Safety Precautions* in the A3S datasheet.

List of Models

Lighted Pushbutton Switches

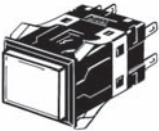
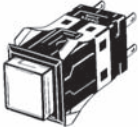
Appearance	Mode
Rectangular 	A3SJ
Square 	A3SA

Model Number Structure

Model Number Legend The model numbers used to order sets are illustrated below. One set comprises the Operation Unit, Lamp, and Socket Unit. For information on combinations, refer to Ordering Information on page 3.

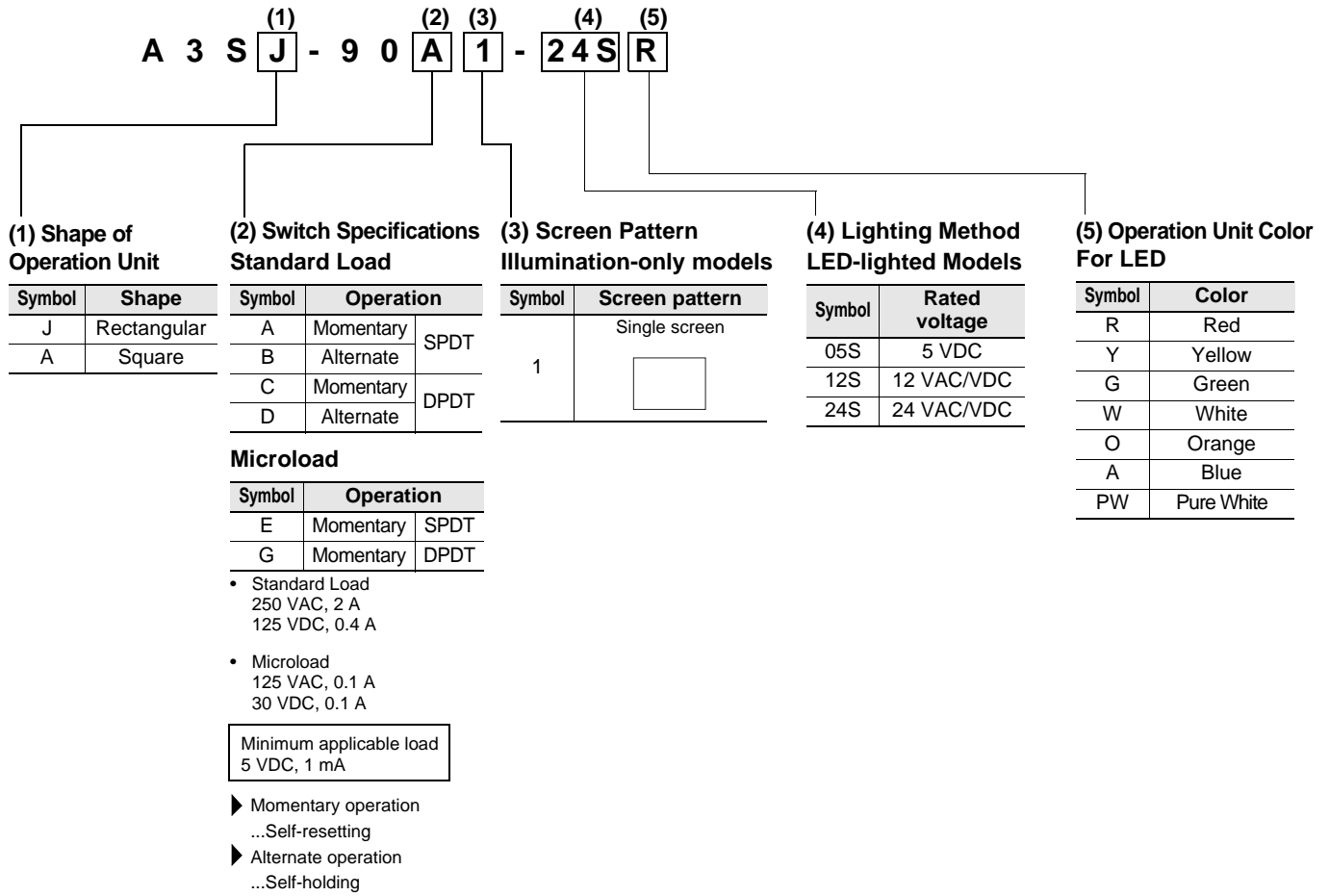

Color of screen	Symbol	R	Y	G	W	O	A	PW
	Color	Red	Yellow	Green	White	Orange	Blue	Pure White
Color of plate		Red	Yellow	Green	White	Orange	Blue	White
LED		Red	Pure White	Green	Amber	Orange	Blue	Pure White

Ordering Information

Ordering as a Set The model numbers used to order sets of Units are given in the following tables. One set comprises the Operation Unit, Lamp, and Socket Unit.

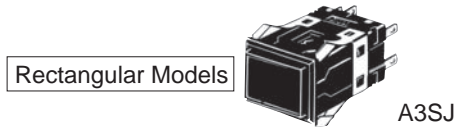

Contact type	No. of outputs	Lighting method	Operation Case color	Momentary operation (Self-resetting)	Alternate operation (Self-holding)	Pushbutton color symbol
Standard Loads	SPDT	LED lamp	5 VDC	A3SJ-90A1-05S(1)	A3SJ-90B1-05S(1)	R, O, G, W, Y, A, or PW
			12 VAC/DC	A3SJ-90A1-12S(1)	A3SJ-90B1-12S(1)	
			24 VAC/DC	A3SJ-90A1-24S(1)	A3SJ-90B1-24S(1)	
	DPDT		5 VDC	A3SJ-90C1-05S(1)	A3SJ-90D1-05S(1)	
			12 VAC/DC	A3SJ-90C1-12S(1)	A3SJ-90D1-12S(1)	
			24 VAC/DC	A3SJ-90C1-24S(1)	A3SJ-90D1-24S(1)	
Microloads	SPDT	5 VDC	A3SJ-90E1-05S(1)	–		
		12 VAC/DC	A3SJ-90E1-12S(1)	–		
		24 VAC/DC	A3SJ-90E1-24S(1)	–		
	DPDT	5 VDC	A3SJ-90G1-05S(1)	–		
		12 VAC/DC	A3SJ-90G1-12S(1)	–		
		24 VAC/DC	A3SJ-90G1-24S(1)	–		

Note: Enter the desired color symbol for the Pushbutton in (1). (R) = Red, (O) = Orange, (G) = Green, (W) = White, (Y) = Yellow, (A) = Blue, (PW) = Pure White.

Example: Red A3SJ-90A1-24SR

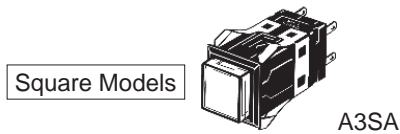

Contact type	No. of outputs	Lighting method	Operation Case color	Momentary operation (Self-resetting)	Alternate operation (Self-holding)	Pushbutton color symbol
Standard Loads	SPDT	LED lamp	5 VDC	A3SA-90A1-05S(1)	A3SA-90B1-05S(1)	R, O, G, W, Y, A, or PW
			12 VAC/DC	A3SA-90A1-12S(1)	A3SA-90B1-12S(1)	
			24 VAC/DC	A3SA-90A1-24S(1)	A3SA-90B1-24S(1)	
	DPDT		5 VDC	A3SA-90C1-05S(1)	A3SA-90D1-05S(1)	
			12 VAC/DC	A3SA-90C1-12S(1)	A3SA-90D1-12S(1)	
			24 VAC/DC	A3SA-90C1-24S(1)	A3SA-90D1-24S(1)	
Microloads	SPDT	5 VDC	A3SA-90E1-05S(1)	–		
		12 VAC/DC	A3SA-90E1-12S(1)	–		
		24 VAC/DC	A3SA-90E1-24S(1)	–		
	DPDT	5 VDC	A3SA-90G1-05S(1)	–		
		12 VAC/DC	A3SA-90G1-12S(1)	–		
		24 VAC/DC	A3SA-90G1-24S(1)	–		

Note: Enter the desired color symbol for the Pushbutton in (1). (R) = Red, (O) = Orange, (G) = Green, (W) = White, (Y) = Yellow, (A) = Blue, (PW) = Pure White.

Example: Red A3SA-90A1-24SR

Accessories and Tools

The accessories and tools are the same as those for the A3S. Refer to the A3S datasheet.

Specifications

Approved Standard Ratings

UL (File No. E41515), CSA (File No. LR45258)

Standard Load: 3 A at 125 VAC
2 A at 250 VAC

Microload: 0.1 A at 125 VAC
0.1 A at 30 VDC

Note: Certification has been obtained for the Switch Unit.
For detailed information on individual products that have received certification, consult your supplier.

Ratings

For Standard Loads

Rated voltage	Non-inductive load (A)				Inductive load (A)			
	Resistive load		Lamp load		Inductive load		Motor load	
	NC	NO	NC	NO	NC	NO	NC	NO
125 VAC	3	1	0.7	2	1.5	1		
250 VAC	2	0.7	0.5	1.5	1	0.7		
8 VDC	3	1		2	1.5			
14 VDC	3	1		1.5	1.5			
30 VDC	2	1		1.5	1			
125 VDC	0.4	0.05		0.4	0.05			
250 VDC	0.2	0.03		0.2	0.03			

- Note:** 1. The above values are for steady-state currents.
2. Inductive load: Power factor = 0.4; time constant = 7 ms.
3. The lamp load has an inrush current of 10 times the steady-state current.
4. The motor load has an inrush current of 6 times the steady-state current.

The rated values are for testing conducted under the following conditions.

- (1) Ambient temperature: 20±2°C
- (2) Ambient humidity: 65% ±5%RH
- (3) Operating frequency: 20 times/min

For Microloads

Rating	0.1 A at 30 VDC (resistive load); 0.1 A at 125 VAC (resistive load)
Minimum applicable load	1 mA at 5 VDC

LED Lamp

Applied voltage	Rated voltage	Rated current
5 VDC±5%	5 VDC	8 mA
12 VAC/VDC±5%	12 VAC/VDC	
24 VAC/VDC±5%	24 VAC/VDC	

Characteristics

Operating frequency	Mechanical	Momentary operation models: 120 operations/min max. *1
	Electrical	20 operations/min max.
Insulation resistance		100 MΩ min. (at 500 VDC)
Contact resistance	Standard load	50 mΩ max. (initial value)
	Microload	50 mΩ max. (initial value)
Dielectric strength	Between terminals of same polarity	1,000 VAC, 50/60 Hz for 1 minute
	Between terminals of different polarity	2,000 VAC, 50/60 Hz for 1 minute
	Between current-carrying metal part and ground	2,000 VAC, 50/60 Hz for 1 minute
	Between each terminal and non-current-carrying metal part	2,000 VAC, 50/60 Hz for 1 minute
	Between lamp terminals	1,000 VAC, 50/60 Hz for 1 minute *2
Vibration resistance	Malfunition	10 to 55 Hz, 1.5-mm double amplitude *3
Shock resistance	Destruction	500 m/s ² max.
	Malfunition	200 m/s ² max. *3
Life expectancy	Mechanical	Momentary operation models: 1,000,000 operations min. Alternate operation models: 100,000 operations min. (One operation consists of set and reset operations.)
	Electrical	100,000 operations min. (rated load)
Weight		Approx. 10 g
Inrush current	NC	Standard load: 10 A max.
	NO	Standard load: 10 A max.
Ambient operating temperature		-10 to 50°C (with no icing or condensation)
Ambient operating humidity		35% to 85% RH
Ambient storage temperature		-25 to 65°C (with no icing or condensation)
Degree of protection		IP00
Electric shock protection class		Class II
PTI (proof tracking index)		175
Pollution degree		3 (IEC 60947-5-1)

*1. With alternate operation models, 60 operations/min max. One operation cycle consists of set and reset operations.

*2. With no incandescent lamp or LED lamp mounted.

*3. Malfunition : 1 ms max.

Operating Characteristics

Operation	Momentary operation models	Alternate operation models
Operating force OF max.	3.92 N	4.90 N
Releasing force RF min.	0.49 N	0.294 N
Total travel TT	Approx. 3 mm	Approx. 3 mm
Pretravel PT max.	2.2 mm	2.2 mm
Lock travel alternate LTA min.	-	0.5 mm

Contact Form

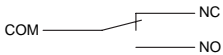
Name	Contact Form
Double-throw contacts	

Panel Cutout (If you use a Switch Guard or Seal Cover, refer to *Switch and Guard Mounting Dimensions* or *Seal Cover Mounting Dimensions* in the A3S datasheet.)

Rectangular Models (A3SJ)

Classification	Mounting design	Panel cutout	Remarks
Flange mount models	Individual mounting, horizontal 		Panel cutout spacing between rows of Units:
	Multiple mounting, horizontal 		
	Individual mounting, vertical 		Panel cutout spacing between rows of Units:
	Multiple mounting, vertical 		
Barrier mount models	Individual mounting, horizontal 		Panel cutout spacing between rows of Units:
	Multiple mounting, horizontal 		
	Individual mounting, vertical 		Dotted line indicates the position of each mounting Barrier.
	Multiple mounting, vertical 		

* If the panel is to be finished (e.g., coated), make sure that the panel meets the specified dimensions after the coating.

Square Models (A3SA)

Classification	Mounting design	Panel cutout	Remarks
Flange mount models	Individual mounting 		Panel cutout spacing between rows of Units:
	Multiple mounting 		
Barrier mount models	Individual mounting 		Panel cutout spacing between rows of Units:
	Multiple mounting 		

* If the panel is to be finished (e.g., coated), make sure that the panel meets the specified dimensions after the coating.

Safety Precautions

Refer to *Safety Precautions for all Pushbutton Switches/Indicators* for common precautions.

Read the *Safety Precautions* in the A3S datasheet.

For technical information and FAQs, refer to Technical Support on the OMRON Industrial Automation website (<http://www.ia.omron.com>).

Terms and Conditions Agreement

Read and understand this catalog.

Please read and understand this catalog before purchasing the products. Please consult your OMRON representative if you have any questions or comments.

Warranties.

(a) Exclusive Warranty. Omron's exclusive warranty is that the Products will be free from defects in materials and workmanship for a period of twelve months from the date of sale by Omron (or such other period expressed in writing by Omron). Omron disclaims all other warranties, express or implied.

(b) Limitations. OMRON MAKES NO WARRANTY OR REPRESENTATION, EXPRESS OR IMPLIED, ABOUT NON-INFRINGEMENT, MERCHANTABILITY OR FITNESS FOR A PARTICULAR PURPOSE OF THE PRODUCTS. BUYER ACKNOWLEDGES THAT IT ALONE HAS DETERMINED THAT THE PRODUCTS WILL SUITABLY MEET THE REQUIREMENTS OF THEIR INTENDED USE.

Omron further disclaims all warranties and responsibility of any type for claims or expenses based on infringement by the Products or otherwise of any intellectual property right. (c) Buyer Remedy. Omron's sole obligation hereunder shall be, at Omron's election, to (i) replace (in the form originally shipped with Buyer responsible for labor charges for removal or replacement thereof) the non-complying Product, (ii) repair the non-complying Product, or (iii) repay or credit Buyer an amount equal to the purchase price of the non-complying Product; provided that in no event shall Omron be responsible for warranty, repair, indemnity or any other claims or expenses regarding the Products unless Omron's analysis confirms that the Products were properly handled, stored, installed and maintained and not subject to contamination, abuse, misuse or inappropriate modification. Return of any Products by Buyer must be approved in writing by Omron before shipment. Omron Companies shall not be liable for the suitability or unsuitability or the results from the use of Products in combination with any electrical or electronic components, circuits, system assemblies or any other materials or substances or environments. Any advice, recommendations or information given orally or in writing, are not to be construed as an amendment or addition to the above warranty.

See <http://www.omron.com/global/> or contact your Omron representative for published information.

Limitation on Liability; Etc.

OMRON COMPANIES SHALL NOT BE LIABLE FOR SPECIAL, INDIRECT, INCIDENTAL, OR CONSEQUENTIAL DAMAGES, LOSS OF PROFITS OR PRODUCTION OR COMMERCIAL LOSS IN ANY WAY CONNECTED WITH THE PRODUCTS, WHETHER SUCH CLAIM IS BASED IN CONTRACT, WARRANTY, NEGLIGENCE OR STRICT LIABILITY.

Further, in no event shall liability of Omron Companies exceed the individual price of the Product on which liability is asserted.

Suitability of Use.

Omron Companies shall not be responsible for conformity with any standards, codes or regulations which apply to the combination of the Product in the Buyer's application or use of the Product. At Buyer's request, Omron will provide applicable third party certification documents identifying ratings and limitations of use which apply to the Product. This information by itself is not sufficient for a complete determination of the suitability of the Product in combination with the end product, machine, system, or other application or use. Buyer shall be solely responsible for determining appropriateness of the particular Product with respect to Buyer's application, product or system. Buyer shall take application responsibility in all cases.

NEVER USE THE PRODUCT FOR AN APPLICATION INVOLVING SERIOUS RISK TO LIFE OR PROPERTY OR IN LARGE QUANTITIES WITHOUT ENSURING THAT THE SYSTEM AS A WHOLE HAS BEEN DESIGNED TO ADDRESS THE RISKS, AND THAT THE OMRON PRODUCT(S) IS PROPERLY RATED AND INSTALLED FOR THE INTENDED USE WITHIN THE OVERALL EQUIPMENT OR SYSTEM.

Programmable Products.

Omron Companies shall not be responsible for the user's programming of a programmable Product, or any consequence thereof.

Performance Data.

Data presented in Omron Company websites, catalogs and other materials is provided as a guide for the user in determining suitability and does not constitute a warranty. It may represent the result of Omron's test conditions, and the user must correlate it to actual application requirements. Actual performance is subject to the Omron's Warranty and Limitations of Liability.

Change in Specifications.

Product specifications and accessories may be changed at any time based on improvements and other reasons. It is our practice to change part numbers when published ratings or features are changed, or when significant construction changes are made. However, some specifications of the Product may be changed without any notice. When in doubt, special part numbers may be assigned to fix or establish key specifications for your application. Please consult with your Omron's representative at any time to confirm actual specifications of purchased Product.

Errors and Omissions.

Information presented by Omron Companies has been checked and is believed to be accurate; however, no responsibility is assumed for clerical, typographical or proofreading errors or omissions.

OMRON Corporation Industrial Automation Company

Tokyo, JAPAN

Contact: www.ia.omron.com

Regional Headquarters

OMRON EUROPE B.V.

Wegalaan 67-69-2132 JD Hoofddorp
The Netherlands

Tel: (31)2356-81-300/Fax: (31)2356-81-388

OMRON ELECTRONICS LLC

One Commerce Drive Schaumburg,
IL 60173-5302 U.S.A.

Tel: (1) 847-843-7900/Fax: (1) 847-843-7787

OMRON ASIA PACIFIC PTE. LTD.

No. 438A Alexandra Road # 05-05/08 (Lobby 2),
Alexandra Technopark,
Singapore 119967

Tel: (65) 6835-3011/Fax: (65) 6835-2711

OMRON (CHINA) CO., LTD.

Room 2211, Bank of China Tower,
200 Yin Cheng Zhong Road,
PuDong New Area, Shanghai, 200120, China

Tel: (86) 21-5037-2222/Fax: (86) 21-5037-2200

Authorized Distributor:

© OMRON Corporation 2013 All Rights Reserved.
In the interest of product improvement,
specifications are subject to change without notice.

Cat. No. A231-E1-01

Printed in Japan
0913 (0913)