

AD8605/AD8606/AD8608

FEATURES

- Low offset voltage: 65 μV maximum
- Low input bias currents: 1 pA maximum
- Low noise: 8 nV/ $\sqrt{\text{Hz}}$
- Wide bandwidth: 10 MHz
- High open-loop gain: 1000 V/mV
- Unity gain stable
- Single-supply operation: 2.7 V to 5.5 V
- 5-ball WLCSP for single (AD8605) and 8-ball WLCSP for dual (AD8606)

APPLICATIONS

- Photodiode amplification
- Battery-powered instrumentation
- Multipole filters
- Sensors
- Barcode scanners
- Audio

GENERAL DESCRIPTION

The AD8605, AD8606, and AD8608¹ are single, dual, and quad rail-to-rail input and output, single-supply amplifiers. They feature very low offset voltage, low input voltage and current noise, and wide signal bandwidth. They use the Analog Devices, Inc. patented DigiTrim[®] trimming technique, which achieves superior precision without laser trimming.

The combination of low offsets, low noise, very low input bias currents, and high speed makes these amplifiers useful in a wide variety of applications. Filters, integrators, photodiode amplifiers, and high impedance sensors all benefit from the combination of performance features. Audio and other ac applications benefit from the wide bandwidth and low distortion. Applications for these amplifiers include optical control loops, portable and loop-powered instrumentation, and audio amplification for portable devices.

The AD8605, AD8606, and AD8608 are specified over the extended industrial temperature range (-40°C to $+125^{\circ}\text{C}$). The AD8605 single is available in 5-lead SOT-23 and 5-ball WLCSP packages. The AD8606 dual is available in an 8-lead MSOP, an 8-ball WLCSP, and a narrow SOIC surface-mounted package. The AD8608 quad is available in a 14-lead TSSOP package and a narrow 14-lead SOIC package. The 5-ball and 8-ball WLCSP offer the smallest available footprint for any surface-mounted operational amplifier. The WLCSP, SOT-23, MSOP, and TSSOP versions are available in tape-and-reel only.

¹ Protected by U.S. Patent No. 5,969,657; other patents pending.

Rev. H

Information furnished by Analog Devices is believed to be accurate and reliable. However, no responsibility is assumed by Analog Devices for its use, nor for any infringements of patents or other rights of third parties that may result from its use. Specifications subject to change without notice. No license is granted by implication or otherwise under any patent or patent rights of Analog Devices. Trademarks and registered trademarks are the property of their respective owners.

FUNCTIONAL BLOCK DIAGRAMS

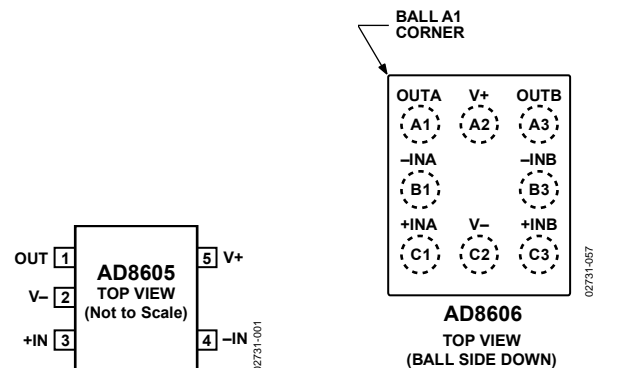

Figure 1. 5-Lead SOT-23 (RJ Suffix)

Figure 2. 8-Ball WLCSP (CB Suffix)

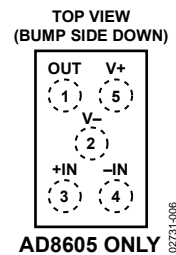

Figure 3. 5-Ball WLCSP (CB Suffix)

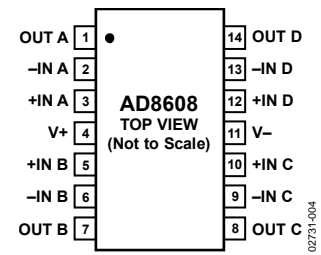

Figure 4. 14-Lead SOIC_N (R Suffix)

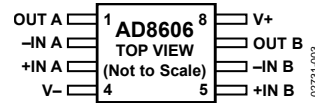

Figure 5. 8-Lead MSOP (RM Suffix),
8-Lead SOIC_N (R Suffix)

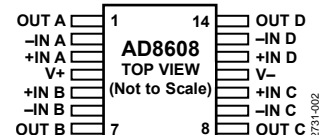

Figure 6. 14-Lead TSSOP (RU Suffix)

TABLE OF CONTENTS

| | | | |
|---|----|--|----|
| Features | 1 | THD + Noise..... | 15 |
| Applications..... | 1 | Total Noise Including Source Resistors | 16 |
| General Description | 1 | Channel Separation..... | 16 |
| Functional Block Diagrams..... | 1 | Capacitive Load Drive | 16 |
| Revision History | 3 | Light Sensitivity | 17 |
| 5 V Electrical Specifications..... | 4 | WLCSP Assembly Considerations..... | 17 |
| 2.7 V Electrical Specifications..... | 6 | I-V Conversion Applications | 18 |
| Absolute Maximum Ratings..... | 8 | Photodiode Preamplifier Applications | 18 |
| ESD Caution..... | 8 | Audio and PDA Applications | 18 |
| Typical Performance Characteristics | 9 | Instrumentation Amplifiers..... | 19 |
| Applications Information | 15 | DAC Conversion | 19 |
| Output Phase Reversal..... | 15 | Outline Dimensions | 20 |
| Maximum Power Dissipation | 15 | Ordering Guide | 22 |
| Input Overvoltage Protection | 15 | | |

REVISION HISTORY**2/08—Rev. G to Rev. H**

| | |
|---|----|
| Changes to Features | 1 |
| Changes to Table 1 | 4 |
| Changes to Table 2 | 6 |
| Changes to Figure 11 | 9 |
| Changes to Figure 13, Figure 14, and Figure 16 Captions | 10 |
| Changes to Figure 15, Figure 17, and Figure 18 | 10 |
| Changes to Figure 34 and Figure 35 Captions | 13 |
| Changes to Figure 36 | 13 |
| Changes to Figure 37 Caption | 14 |
| Changes to Figure 38 and Figure 41 | 14 |
| Changes to Figure 45 | 15 |
| Changes to Audio and PDA Applications Section | 18 |
| Changes to Figure 52 | 18 |
| Changes to Ordering Guide | 22 |

10/07—Rev. F to Rev. G

| | |
|----------------------------------|----|
| Changes to Figure 2 | 1 |
| Updated Outline Dimensions | 20 |

8/07—Rev. E to Rev. F

| | |
|----------------------------------|-----------|
| Added 8-Ball WLCSP Package | Universal |
| Changes to Features | 1 |
| Changes to Table 1 | 3 |
| Changes to Table 2 | 5 |
| Changes to Table 4 | 7 |
| Updated Outline Dimensions | 19 |
| Changes to Ordering Guide | 21 |

1/06—Rev. D to Rev. E

| | |
|---|----|
| Changes to Table 1 | 3 |
| Changes to Table 2 | 5 |
| Changes to Table 4 | 6 |
| Changes to Figure 12 Caption | 8 |
| Changes to Figure 26 and Figure 27 Captions | 11 |
| Changes to Figure 33 Caption | 12 |
| Changes to Figure 44 | 14 |
| Updated Outline Dimensions | 19 |
| Changes to Ordering Guide | 20 |

5/04—Rev. C to Rev. D

| | |
|---|-----------|
| Updated Format | Universal |
| Edit to Light Sensitivity Section | 16 |

| | |
|----------------------------------|----|
| Updated Outline Dimensions | 19 |
| Changes to Ordering Guide | 20 |

7/03—Rev. B to Rev. C

| | |
|--|----|
| Changes to Features | 1 |
| Change to General Description | 1 |
| Addition to Functional Block Diagrams | 1 |
| Addition to Absolute Maximum Ratings | 4 |
| Addition to Ordering Guide | 4 |
| Change to Equation in Maximum Power Dissipation Section | 11 |
| Added Light Sensitivity Section | 12 |
| Added New Figure 8; Renumbered Subsequently | 13 |
| Added New MicroCSP Assembly Considerations Section | 13 |
| Changes to Figure 9 | 13 |
| Change to Equation in Photodiode Preamplifier Applications Section | 13 |
| Changes to Figure 12 | 14 |
| Change to Equation in D/A Conversion Section | 14 |
| Updated Outline Dimensions | 15 |

3/03—Rev. A to Rev. B

| | |
|---|----|
| Changes to Functional Block Diagram | 1 |
| Changes to Absolute Maximum Ratings | 4 |
| Changes to Ordering Guide | 4 |
| Changes to Figure 9 | 13 |
| Updated Outline Dimensions | 15 |

11/02—Rev. 0 to Rev. A

| | |
|--|----|
| Change to Electrical Characteristics | 2 |
| Changes to Absolute Maximum Ratings | 4 |
| Changes to Ordering Guide | 4 |
| Change to TPC 6 | 5 |
| Updated Outline Dimensions | 15 |

5/02—Revision 0: Initial Version

AD8605/AD8606/AD8608

5 V ELECTRICAL SPECIFICATIONS

$V_S = 5\text{ V}$, $V_{CM} = V_S/2$, $T_A = 25^\circ\text{C}$, unless otherwise noted.

Table 1.

| Parameter | Symbol | Conditions | Min | Typ | Max | Unit |
|--------------------------------|--------------------------|---|--------------------|--------------|-----------|---|
| INPUT CHARACTERISTICS | | | | | | |
| Offset Voltage | V_{OS} | | | | | |
| AD8605/AD8606 (Except WLCSP) | | $V_S = 3.5\text{ V}$, $V_{CM} = 3\text{ V}$ | | 20 | 65 | μV |
| AD8608 | | $V_S = 3.5\text{ V}$, $V_{CM} = 2.7\text{ V}$ | | 20 | 75 | μV |
| AD8605/AD8606/AD8608 | | $V_S = 5\text{ V}$, $V_{CM} = 0\text{ V to } 5\text{ V}$ $-40^\circ\text{C} < T_A < +125^\circ\text{C}$ | | 80 | 300 | μV |
| | | | | | 750 | μV |
| Input Bias Current | I_B | | | 0.2 | 1 | pA |
| AD8605/AD8606 | | $-40^\circ\text{C} < T_A < +85^\circ\text{C}$ | | | 50 | pA |
| AD8605/AD8606 | | $-40^\circ\text{C} < T_A < +125^\circ\text{C}$ | | | 250 | pA |
| AD8608 | | $-40^\circ\text{C} < T_A < +85^\circ\text{C}$ | | | 100 | pA |
| AD8608 | | $-40^\circ\text{C} < T_A < +125^\circ\text{C}$ | | | 300 | pA |
| Input Offset Current | I_{OS} | | | 0.1 | 0.5 | pA |
| | | $-40^\circ\text{C} < T_A < +85^\circ\text{C}$ | | | 20 | pA |
| | | $-40^\circ\text{C} < T_A < +125^\circ\text{C}$ | | | 75 | pA |
| Input Voltage Range | | | 0 | | 5 | V |
| Common-Mode Rejection Ratio | CMRR | $V_{CM} = 0\text{ V to } 5\text{ V}$ $-40^\circ\text{C} < T_A < +125^\circ\text{C}$ | 85 | 100 | | dB |
| | | | 75 | 90 | | dB |
| Large Signal Voltage Gain | A_{VO} | $R_L = 2\text{ k}\Omega$, $V_O = 0.5\text{ V to } 4.5\text{ V}$ | 300 | 1000 | | V/mV |
| Offset Voltage Drift | | | | | | |
| AD8605/AD8606 | $\Delta V_{OS}/\Delta T$ | $-40^\circ\text{C} < T_A < +125^\circ\text{C}$ | | 1 | 4.5 | $\mu\text{V}/^\circ\text{C}$ |
| AD8608 | $\Delta V_{OS}/\Delta T$ | $-40^\circ\text{C} < T_A < +125^\circ\text{C}$ | | 1.5 | 6.0 | $\mu\text{V}/^\circ\text{C}$ |
| INPUT CAPACITANCE | | | | | | |
| Common-Mode Input Capacitance | C_{COM} | | | 8.8 | | pF |
| Differential Input Capacitance | C_{DIFF} | | | 2.6 | | pF |
| OUTPUT CHARACTERISTICS | | | | | | |
| Output Voltage High | V_{OH} | $I_L = 1\text{ mA}$ $I_L = 10\text{ mA}$ $-40^\circ\text{C} < T_A < +125^\circ\text{C}$ | 4.96 4.7 4.6 | 4.98 4.79 | | V V V |
| Output Voltage Low | V_{OL} | $I_L = 1\text{ mA}$ $I_L = 10\text{ mA}$ $-40^\circ\text{C} < T_A < +125^\circ\text{C}$ | | 20 170 | 40 210 | mV mV mV |
| | | | | | 290 | mV |
| Output Current | I_{OUT} | | | ± 80 | | mA |
| Closed-Loop Output Impedance | Z_{OUT} | $f = 1\text{ MHz}$, $A_V = 1$ | | 1 | | Ω |
| POWER SUPPLY | | | | | | |
| Power Supply Rejection Ratio | PSRR | | | | | |
| AD8605/AD8606 | | $V_S = 2.7\text{ V to } 5.5\text{ V}$ | 80 | 95 | | dB |
| AD8605/AD8606 WLCSP | | $V_S = 2.7\text{ V to } 5.5\text{ V}$ | 75 | 92 | | dB |
| AD8608 | | $V_S = 2.7\text{ V to } 5.5\text{ V}$ $-40^\circ\text{C} < T_A < +125^\circ\text{C}$ | 77 70 | 92 90 | | dB dB |
| Supply Current/Amplifier | I_{SY} | $I_{OUT} = 0\text{ mA}$ $-40^\circ\text{C} < T_A < +125^\circ\text{C}$ | | 1 | 1.2 | mA |
| | | | | | 1.4 | mA |
| DYNAMIC PERFORMANCE | | | | | | |
| Slew Rate | SR | $R_L = 2\text{ k}\Omega$, $C_L = 16\text{ pF}$ | | 5 | | $\text{V}/\mu\text{s}$ |
| Settling Time | t_s | To 0.01%, 0 V to 2 V step, $A_V = 1$ | | <1 | | μs |
| Unity Gain Bandwidth Product | GBP | | | 10 | | MHz |
| Phase Margin | Φ_M | | | 65 | | Degrees |

AD8605/AD8606/AD8608

| Parameter | Symbol | Conditions | Min | Typ | Max | Unit |
|-----------------------|---------------|--|------------|------------|------------|------------------------------|
| NOISE PERFORMANCE | | | | | | |
| Peak-to-Peak Noise | e_n p-p | $f = 0.1 \text{ Hz to } 10 \text{ Hz}$ | | 2.3 | 3.5 | $\mu\text{V p-p}$ |
| Voltage Noise Density | e_n | $f = 1 \text{ kHz}$ | | 8 | 12 | $\text{nV}/\sqrt{\text{Hz}}$ |
| | e_n | $f = 10 \text{ kHz}$ | | 6.5 | | $\text{nV}/\sqrt{\text{Hz}}$ |
| Current Noise Density | i_n | $f = 1 \text{ kHz}$ | | 0.01 | | $\text{pA}/\sqrt{\text{Hz}}$ |

AD8605/AD8606/AD8608

2.7 V ELECTRICAL SPECIFICATIONS

$V_S = 2.7\text{ V}$, $V_{CM} = V_S/2$, $T_A = 25^\circ\text{C}$, unless otherwise noted.

Table 2.

| Parameter | Symbol | Conditions | Min | Typ | Max | Unit |
|--------------------------------|--------------------------|--|-----|----------|-----|------------------------------|
| INPUT CHARACTERISTICS | | | | | | |
| Offset Voltage | V_{OS} | | | | | |
| AD8605/AD8606 (Except WLCSP) | | $V_S = 3.5\text{ V}$, $V_{CM} = 3\text{ V}$ | | 20 | 65 | μV |
| AD8608 | | $V_S = 3.5\text{ V}$, $V_{CM} = 2.7\text{ V}$ | | 20 | 75 | μV |
| AD8605/AD8606/AD8608 | | $V_S = 2.7\text{ V}$, $V_{CM} = 0\text{ V to }2.7\text{ V}$ $-40^\circ\text{C} < T_A < +125^\circ\text{C}$ | | 80 | 300 | μV |
| | | | | | 750 | μV |
| Input Bias Current | I_B | | | 0.2 | 1 | pA |
| AD8605/AD8606 | | $-40^\circ\text{C} < T_A < +85^\circ\text{C}$ | | | 50 | pA |
| AD8605/AD8606 | | $-40^\circ\text{C} < T_A < +125^\circ\text{C}$ | | | 250 | pA |
| AD8608 | | $-40^\circ\text{C} < T_A < +85^\circ\text{C}$ | | | 100 | pA |
| AD8608 | | $-40^\circ\text{C} < T_A < +125^\circ\text{C}$ | | | 300 | pA |
| Input Offset Current | I_{OS} | | | 0.1 | 0.5 | pA |
| | | $-40^\circ\text{C} < T_A < +85^\circ\text{C}$ | | | 20 | pA |
| | | $-40^\circ\text{C} < T_A < +125^\circ\text{C}$ | | | 75 | pA |
| Input Voltage Range | | | 0 | | 2.7 | V |
| Common-Mode Rejection Ratio | CMRR | $V_{CM} = 0\text{ V to }2.7\text{ V}$ $-40^\circ\text{C} < T_A < +125^\circ\text{C}$ | 80 | 95 | | dB |
| | | | 70 | 85 | | dB |
| Large Signal Voltage Gain | A_{VO} | $R_L = 2\text{ k}\Omega$, $V_O = 0.5\text{ V to }2.2\text{ V}$ | 110 | 350 | | V/mV |
| Offset Voltage Drift | | | | | | |
| AD8605/AD8606 | $\Delta V_{OS}/\Delta T$ | $-40^\circ\text{C} < T_A < +125^\circ\text{C}$ | | 1 | 4.5 | $\mu\text{V}/^\circ\text{C}$ |
| AD8608 | $\Delta V_{OS}/\Delta T$ | $-40^\circ\text{C} < T_A < +125^\circ\text{C}$ | | 1.5 | 6.0 | $\mu\text{V}/^\circ\text{C}$ |
| INPUT CAPACITANCE | | | | | | |
| Common-Mode Input Capacitance | C_{COM} | | | 8.8 | | pF |
| Differential Input Capacitance | C_{DIFF} | | | 2.6 | | pF |
| OUTPUT CHARACTERISTICS | | | | | | |
| Output Voltage High | V_{OH} | $I_L = 1\text{ mA}$ $-40^\circ\text{C} < T_A < +125^\circ\text{C}$ | 2.6 | 2.66 | | V |
| | | | 2.6 | | | V |
| Output Voltage Low | V_{OL} | $I_L = 1\text{ mA}$ $-40^\circ\text{C} < T_A < +125^\circ\text{C}$ | | 25 | 40 | mV |
| | | | | | 50 | mV |
| Output Current | I_{OUT} | | | ± 30 | | mA |
| Closed-Loop Output Impedance | Z_{OUT} | $f = 1\text{ MHz}$, $A_V = 1$ | | 1.2 | | Ω |
| POWER SUPPLY | | | | | | |
| Power Supply Rejection Ratio | PSRR | | | | | |
| AD8605/AD8606 | | $V_S = 2.7\text{ V to }5.5\text{ V}$ | 80 | 95 | | dB |
| AD8605/AD8606 WLCSP | | $V_S = 2.7\text{ V to }5.5\text{ V}$ | 75 | 92 | | dB |
| AD8608 | | $V_S = 2.7\text{ V to }5.5\text{ V}$ $-40^\circ\text{C} < T_A < +125^\circ\text{C}$ | 77 | 92 | | dB |
| | | | 70 | 90 | | dB |
| Supply Current/Amplifier | I_{SY} | $I_{OUT} = 0\text{ mA}$ $-40^\circ\text{C} < T_A < +125^\circ\text{C}$ | | 1.15 | 1.4 | mA |
| | | | | | 1.5 | mA |
| DYNAMIC PERFORMANCE | | | | | | |
| Slew Rate | SR | $R_L = 2\text{ k}\Omega$, $C_L = 16\text{ pF}$ | | 5 | | $\text{V}/\mu\text{s}$ |
| Settling Time | t_s | To 0.01%, 0 V to 1 V step, $A_V = 1$ | | <0.5 | | μs |
| Unity Gain Bandwidth Product | GBP | | | 9 | | MHz |
| Phase Margin | Φ_M | | | 50 | | Degrees |

AD8605/AD8606/AD8608

| Parameter | Symbol | Conditions | Min | Typ | Max | Unit |
|-----------------------|---------------|---------------------|------------|------------|------------|------------------------------|
| NOISE PERFORMANCE | | | | | | |
| Peak-to-Peak Noise | e_n p-p | f = 0.1 Hz to 10 Hz | | 2.3 | 3.5 | $\mu\text{V p-p}$ |
| Voltage Noise Density | e_n | f = 1 kHz | | 8 | 12 | $\text{nV}/\sqrt{\text{Hz}}$ |
| | e_n | f = 10 kHz | | 6.5 | | $\text{nV}/\sqrt{\text{Hz}}$ |
| Current Noise Density | i_n | f = 1 kHz | | 0.01 | | $\text{pA}/\sqrt{\text{Hz}}$ |

ABSOLUTE MAXIMUM RATINGS

Table 3.

| Parameter | Rating |
|--------------------------------------|-------------------------|
| Supply Voltage | 6 V |
| Input Voltage | GND to V_S |
| Differential Input Voltage | 6 V |
| Output Short-Circuit Duration to GND | Observe Derating Curves |
| Storage Temperature Range | |
| All Packages | −65°C to +150°C |
| Operating Temperature Range | |
| All Packages | −40°C to +125°C |
| Junction Temperature Range | |
| All Packages | −65°C to +150°C |
| Lead Temperature (Soldering, 60 sec) | 300°C |

Stresses above those listed under Absolute Maximum Ratings may cause permanent damage to the device. This is a stress rating only; functional operation of the device at these or any other conditions above those indicated in the operational section of this specification is not implied. Exposure to absolute maximum rating conditions for extended periods may affect device reliability.

Table 4.

| Package Type | θ_{JA}^1 | θ_{JC} | Unit |
|--------------------|-----------------|---------------|------|
| 5-Ball WLCSP (CB) | 170 | | °C/W |
| 5-Lead SOT-23 (RJ) | 240 | 92 | °C/W |
| 8-Ball WLCSP (CB) | 115 | | °C/W |
| 8-Lead MSOP (RM) | 206 | 44 | °C/W |
| 8-Lead SOIC_N (R) | 157 | 56 | °C/W |
| 14-Lead SOIC_N (R) | 105 | 36 | °C/W |
| 14-Lead TSSOP (RU) | 148 | 23 | °C/W |

¹ θ_{JA} is specified for the worst-case conditions, that is, a device soldered in a circuit board for surface-mount packages.

ESD CAUTION



ESD (electrostatic discharge) sensitive device. Charged devices and circuit boards can discharge without detection. Although this product features patented or proprietary protection circuitry, damage may occur on devices subjected to high energy ESD. Therefore, proper ESD precautions should be taken to avoid performance degradation or loss of functionality.

TYPICAL PERFORMANCE CHARACTERISTICS

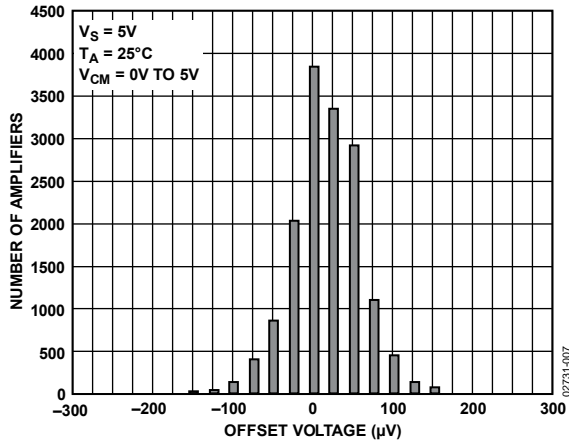

Figure 7. Input Offset Voltage Distribution

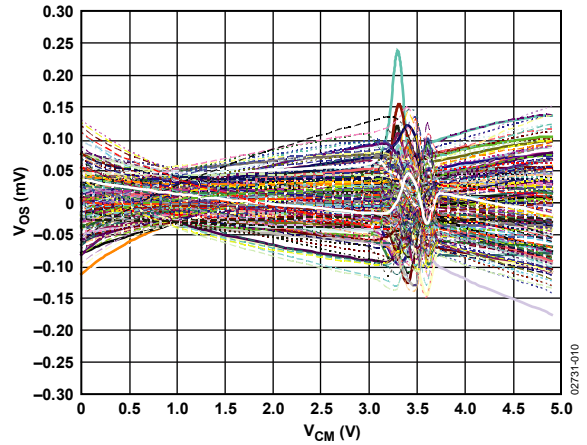

Figure 10. Input Offset Voltage vs. Common-Mode Voltage (200 Units, 5 Wafer Lots, Including Process Skews)

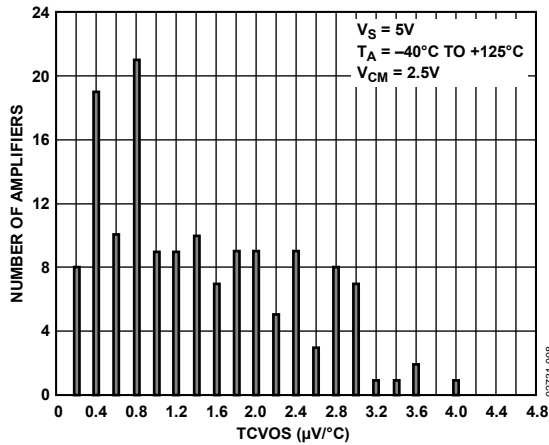

Figure 8. AD8608 Input Offset Voltage Drift Distribution

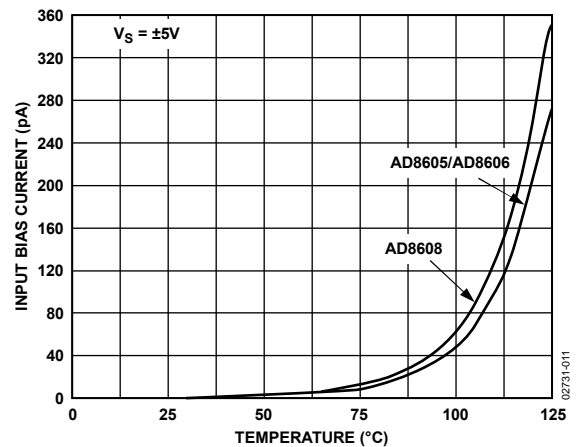

Figure 11. Input Bias Current vs. Temperature

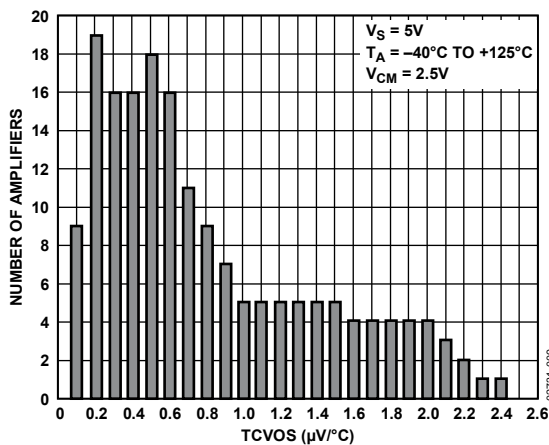

Figure 9. AD8605/AD8606 Input Offset Voltage Drift Distribution

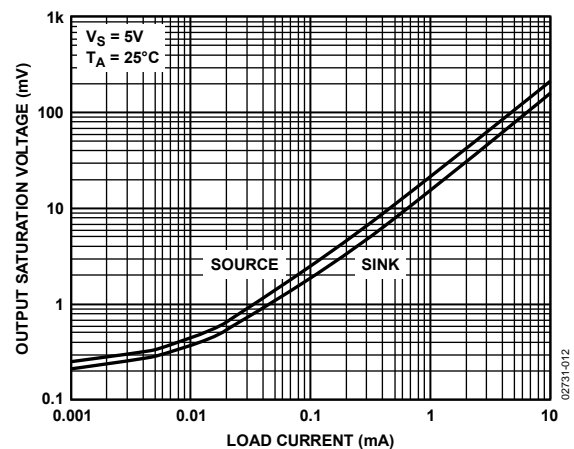

Figure 12. Output Saturation Voltage vs. Load Current

AD8605/AD8606/AD8608

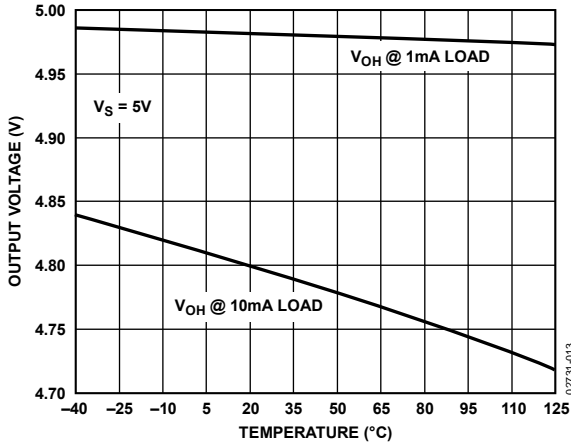

Figure 13. Output Voltage Swing High vs. Temperature

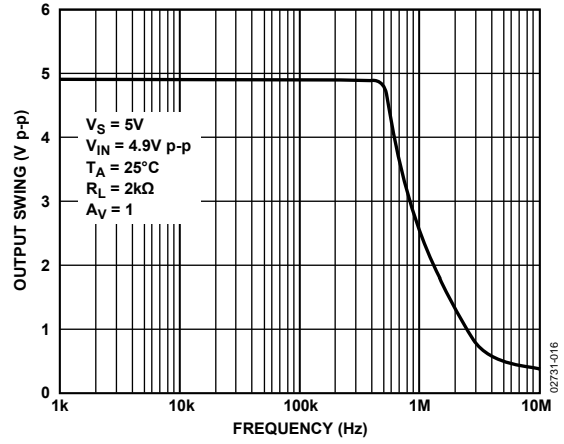

Figure 16. Closed-Loop Output Voltage Swing (FPBW)

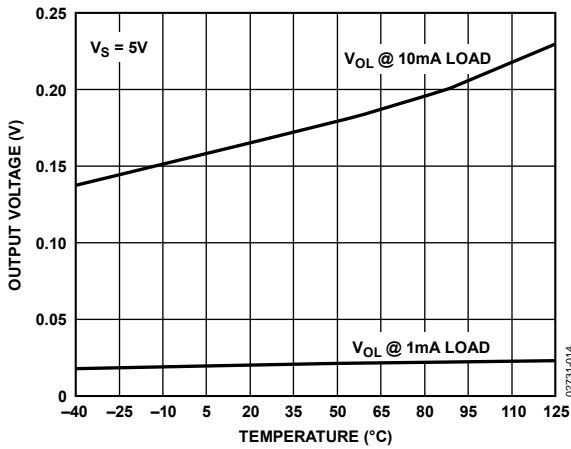

Figure 14. Output Voltage Swing Low vs. Temperature

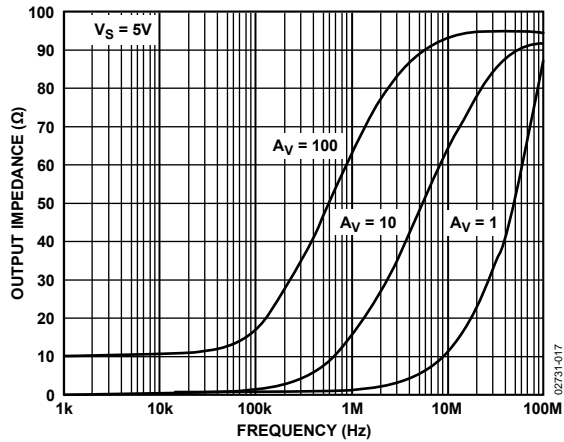

Figure 17. Output Impedance vs. Frequency

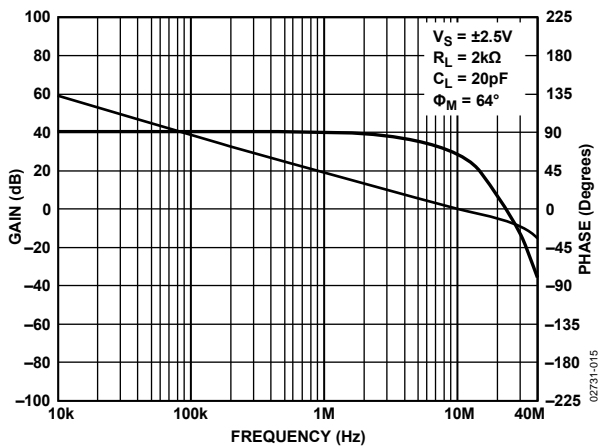

Figure 15. Open-Loop Gain and Phase vs. Frequency

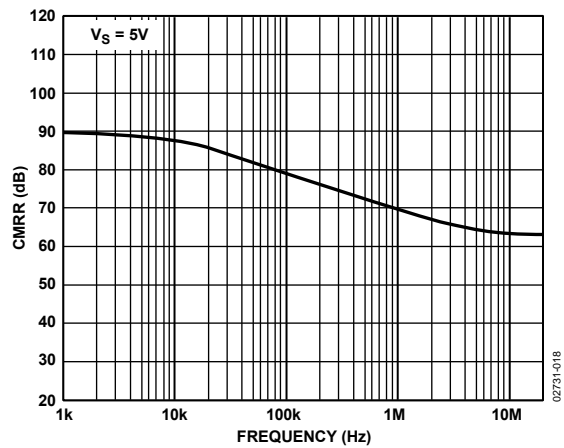

Figure 18. Common-Mode Rejection Ratio (CMRR) vs. Frequency

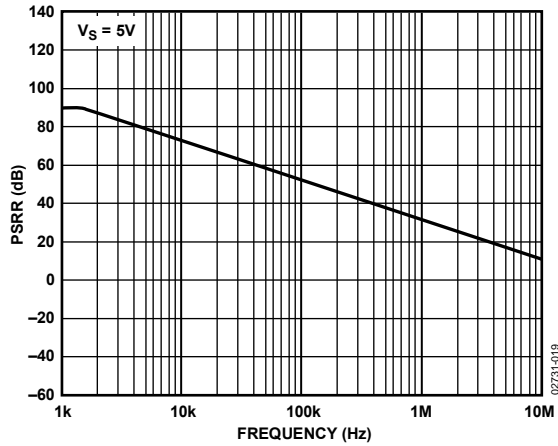

Figure 19. PSRR vs. Frequency

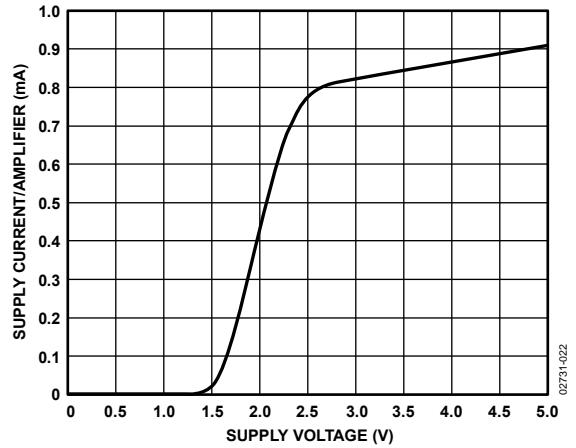

Figure 22. Supply Current/Amplifier vs. Supply Voltage

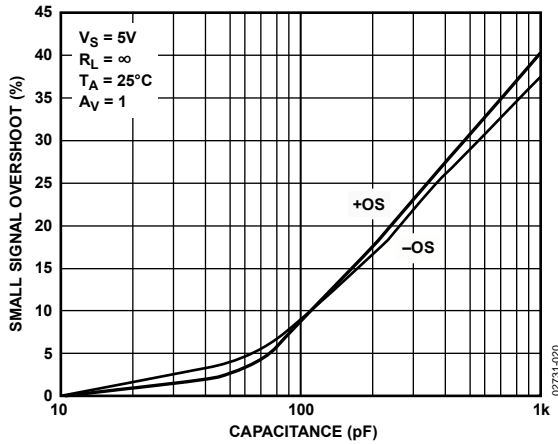

Figure 20. Small Signal Overshoot vs. Load Capacitance

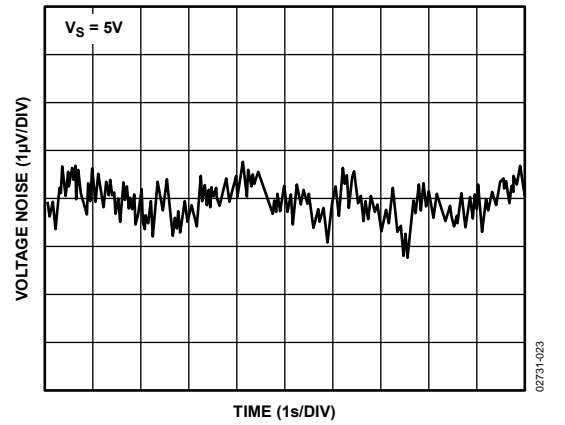

Figure 23. 0.1 Hz to 10 Hz Input Voltage Noise

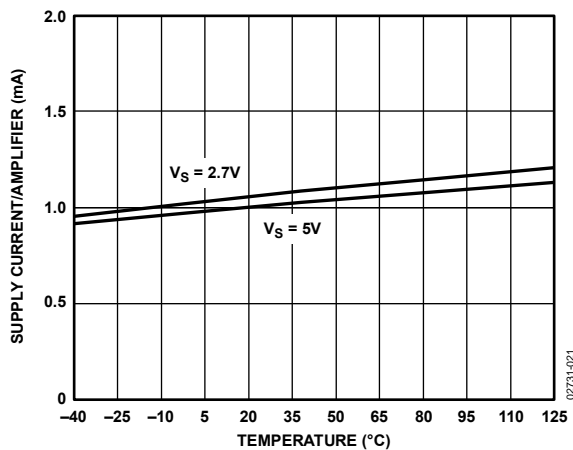

Figure 21. Supply Current/Amplifier vs. Temperature

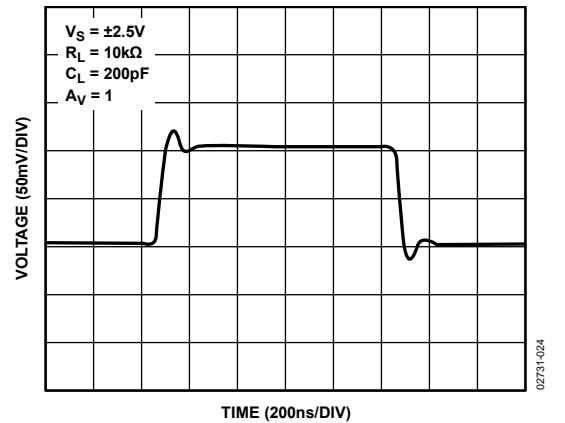

Figure 24. Small Signal Transient Response

AD8605/AD8606/AD8608

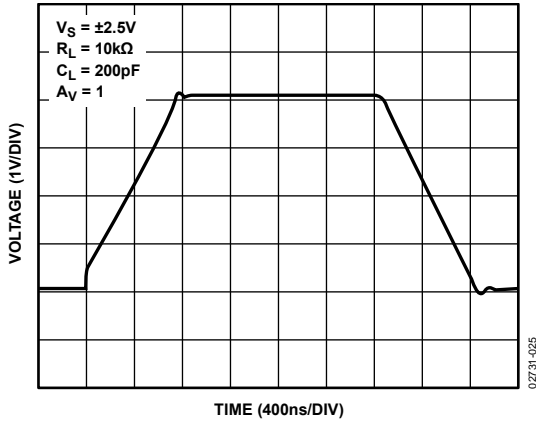

Figure 25. Large Signal Transient Response

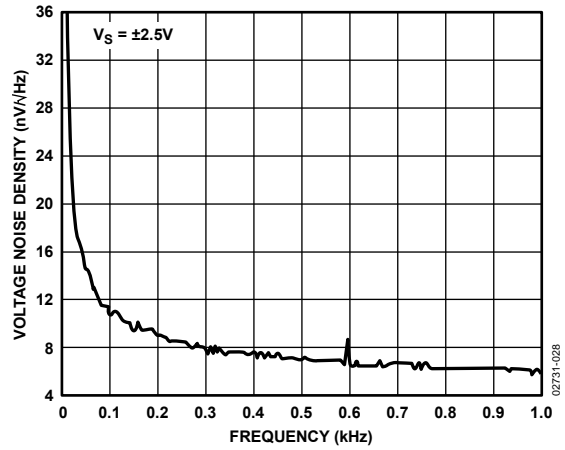

Figure 28. Voltage Noise Density vs. Frequency

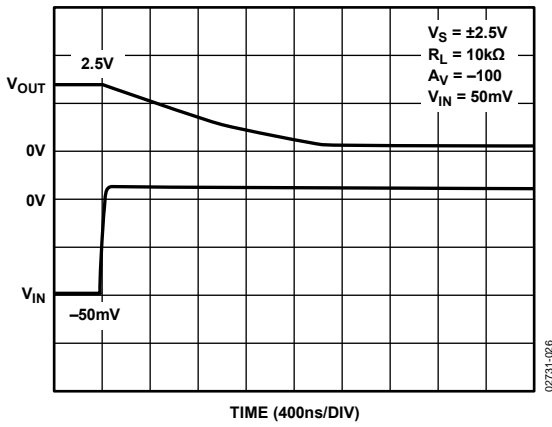

Figure 26. Positive Overload Recovery

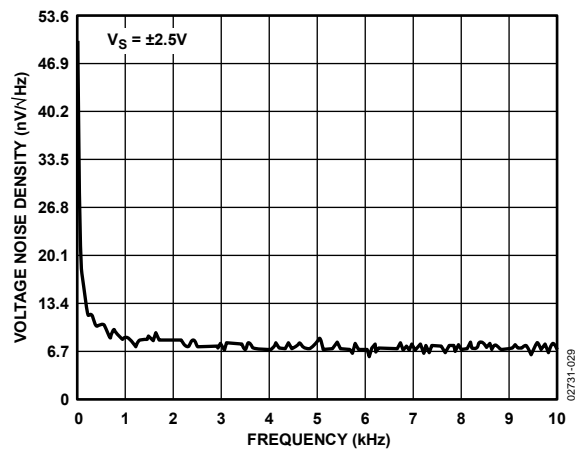

Figure 29. Voltage Noise Density vs. Frequency

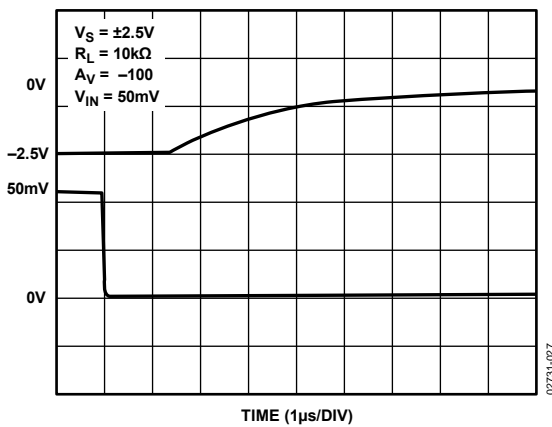

Figure 27. Negative Overload Recovery

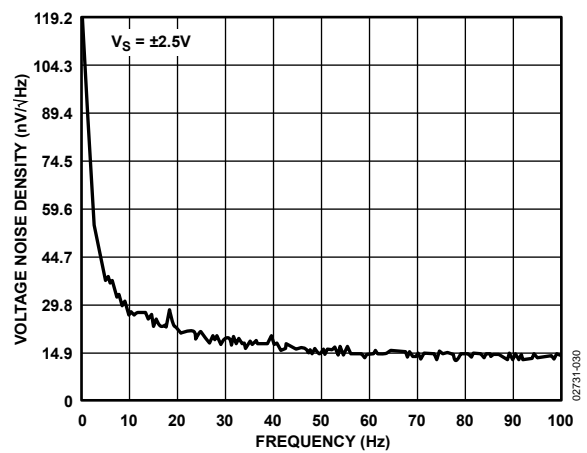

Figure 30. Voltage Noise Density vs. Frequency

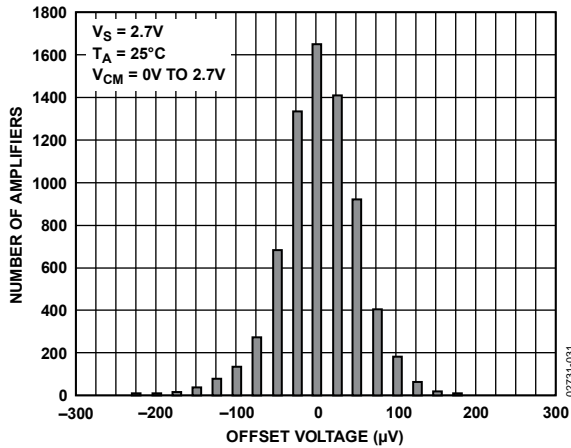

Figure 31. Input Offset Voltage Distribution

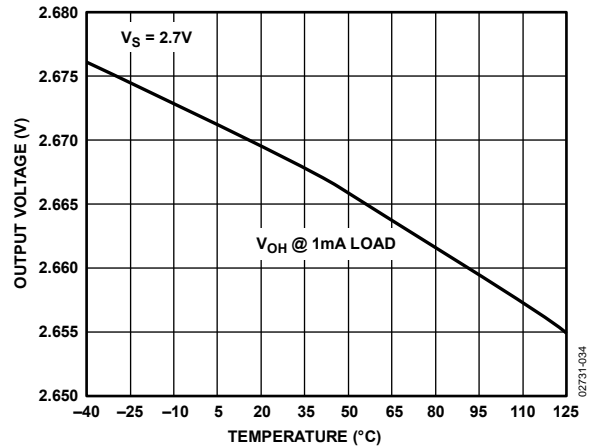

Figure 34. Output Voltage Swing High vs. Temperature

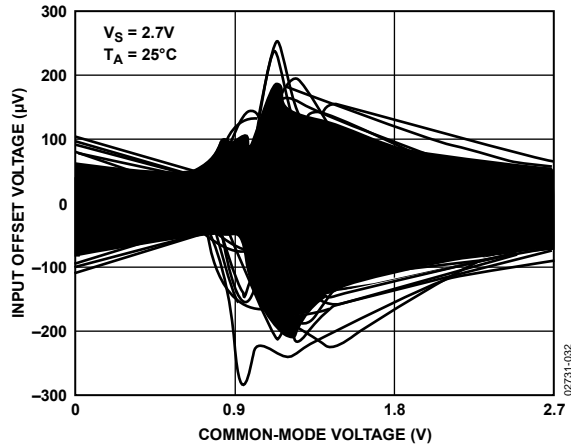

Figure 32. Input Offset Voltage vs. Common-Mode Voltage (200 Units, 5 Wafer Lots, Including Process Skews)

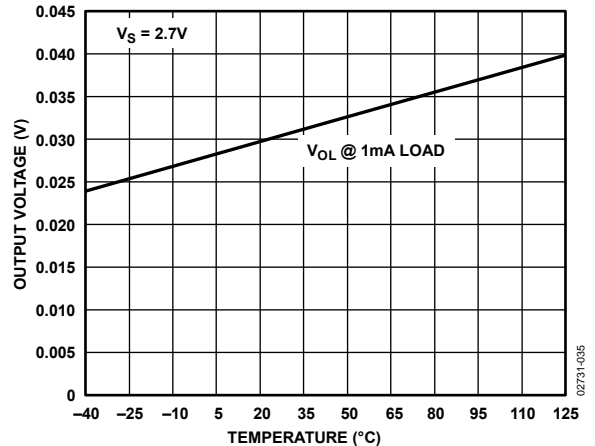

Figure 35. Output Voltage Swing Low vs. Temperature

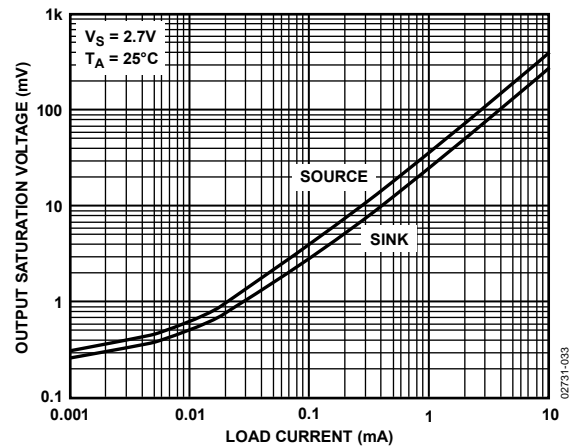

Figure 33. Output Saturation Voltage vs. Load Current

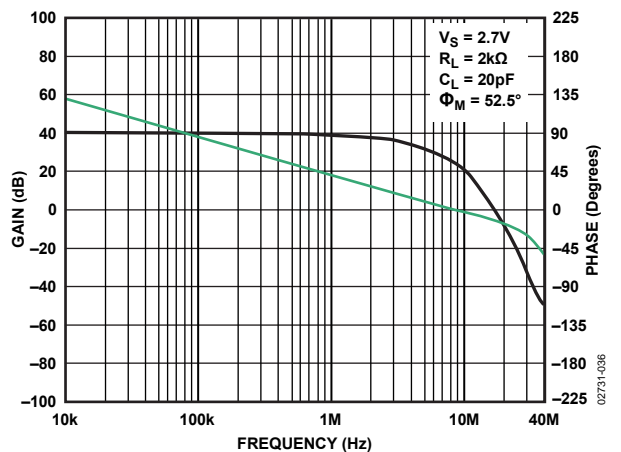

Figure 36. Open-Loop Gain and Phase vs. Frequency

AD8605/AD8606/AD8608

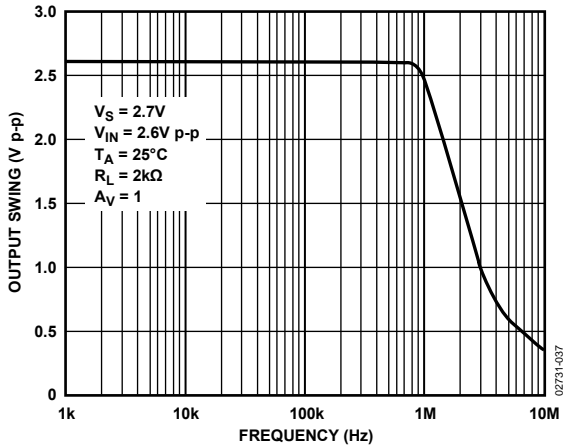

Figure 37. Closed-Loop Output Voltage Swing vs. Frequency (FPBW)

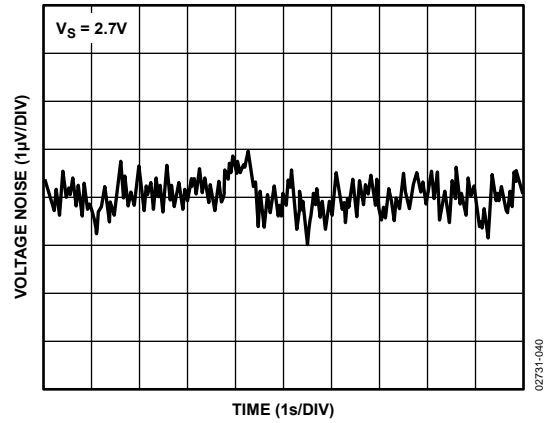

Figure 40. 0.1 Hz to 10 Hz Input Voltage Noise

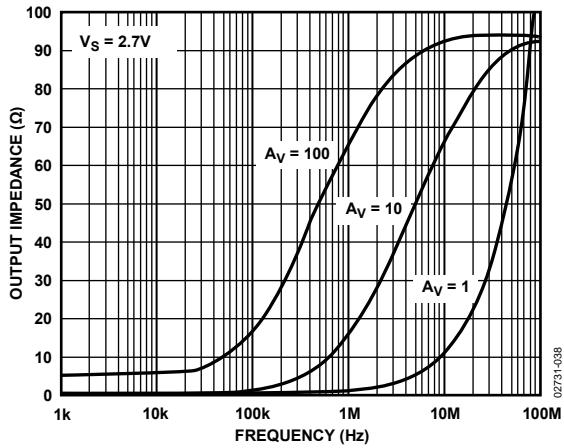

Figure 38. Output Impedance vs. Frequency

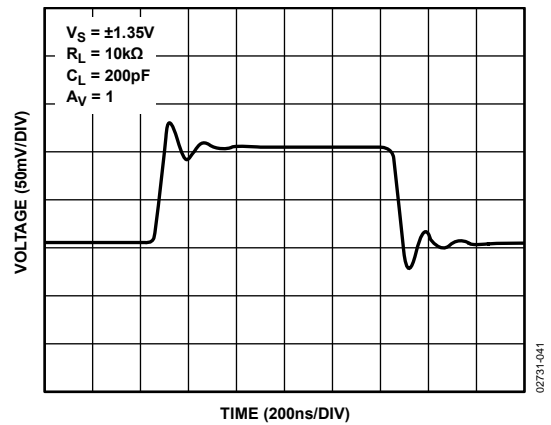

Figure 41. Small Signal Transient Response

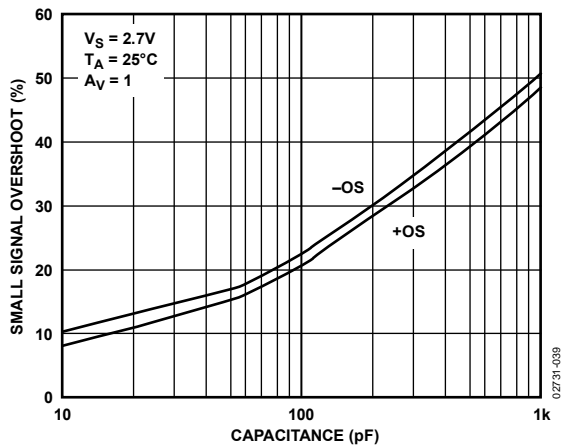

Figure 39. Small Signal Overshoot vs. Load Capacitance

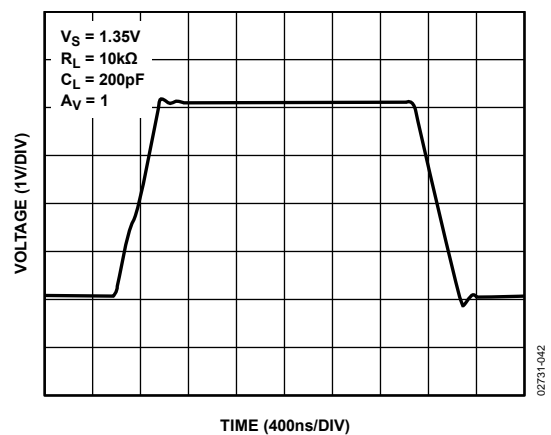

Figure 42. Large Signal Transient Response

APPLICATIONS INFORMATION

OUTPUT PHASE REVERSAL

Phase reversal is defined as a change in polarity at the output of the amplifier when a voltage that exceeds the maximum input common-mode voltage drives the input.

Phase reversal can cause permanent damage to the amplifier; it can also cause system lockups in feedback loops. The AD8605 does not exhibit phase reversal even for inputs exceeding the supply voltage by more than 2 V.

MAXIMUM POWER DISSIPATION

Power dissipated in an IC causes the die temperature to increase, which can affect the behavior of the IC and the application circuit performance.

The absolute maximum junction temperature of the AD8605/AD8606/AD8608 is 150°C. Exceeding this temperature could damage or destroy the device.

The maximum power dissipation of the amplifier is calculated according to

$$P_{DISS} = \frac{T_J - T_A}{\theta_{JA}}$$

where:

T_J is the junction temperature.

T_A is the ambient temperature.

θ_{JA} is the junction-to-ambient thermal resistance.

Figure 44 compares the maximum power dissipation with temperature for the various AD860x family packages.

INPUT OVERVOLTAGE PROTECTION

The AD8605 has internal protective circuitry. However, if the voltage applied at either input exceeds the supplies by more than 2.5 V, external resistors should be placed in series with the inputs. The resistor values can be determined by

$$\frac{V_{IN} - V_S}{R_S + 200\Omega} \leq 5\text{mA}$$

The remarkable low input offset current of the AD8605 (<1 pA) allows the use of larger value resistors. With a 10 kΩ resistor at the input, the output voltage has less than 10 nV of error voltage. A 10 kΩ resistor has less than 13 nV/√Hz of thermal noise at room temperature.

THD + NOISE

Total harmonic distortion is the ratio of the input signal in V rms to the total harmonics in V rms throughout the spectrum.

Harmonic distortion adds errors to precision measurements and adds unpleasant sonic artifacts to audio systems.

The AD8605 has a low total harmonic distortion. Figure 45 shows that the AD8605 has less than 0.005% or -86 dB of THD + N over the entire audio frequency range. The AD8605 is configured in positive unity gain, which is the worst case, and with a load of 10 kΩ.

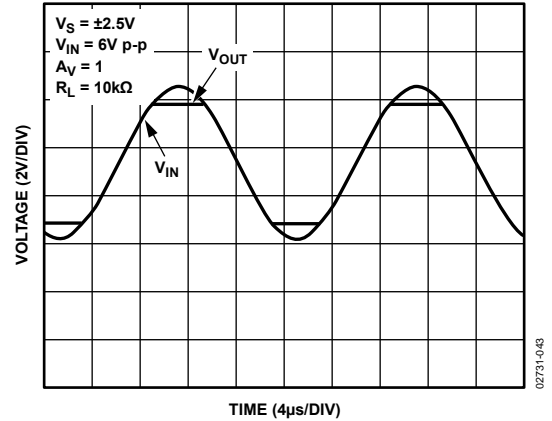

Figure 43. No Phase Reversal

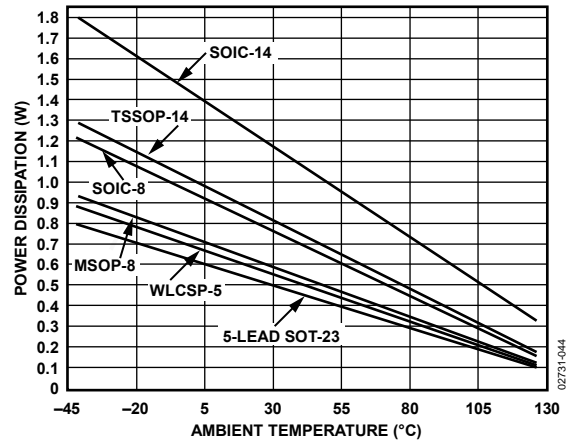

Figure 44. Maximum Power Dissipation vs. Ambient Temperature

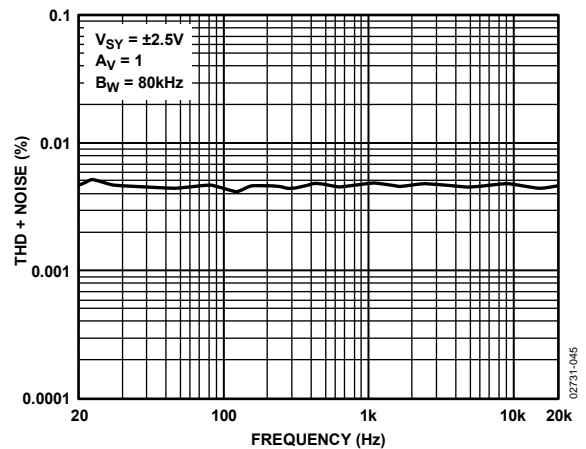

Figure 45. THD + Noise vs. Frequency

AD8605/AD8606/AD8608

TOTAL NOISE INCLUDING SOURCE RESISTORS

The low input current noise and input bias current of the AD8605 make it the ideal amplifier for circuits with substantial input source resistance, such as photodiodes. Input offset voltage increases by less than 0.5 nV per 1 kΩ of source resistance at room temperature and increases to 10 nV at 85°C. The total noise density of the circuit is

$$e_{n,TOTAL} = \sqrt{e_n^2 + (i_n R_S)^2 + 4kTR_S}$$

where:

e_n is the input voltage noise density of the AD8605.

i_n is the input current noise density of the AD8605.

R_S is the source resistance at the noninverting terminal.

k is Boltzmann's constant (1.38×10^{-23} J/K).

T is the ambient temperature in Kelvin ($T = 273 + ^\circ\text{C}$).

For example, with $R_S = 10$ kΩ, the total voltage noise density is roughly 15 nV/√Hz.

For $R_S < 3.9$ kΩ, e_n dominates and $e_{n,TOTAL} \approx e_n$.

The current noise of the AD8605 is so low that its total density does not become a significant term unless R_S is greater than 6 MΩ.

The total equivalent rms noise over a specific bandwidth is expressed as

$$E_n = (e_{n,TOTAL}) \sqrt{BW}$$

where BW is the bandwidth in hertz.

Note that the previous analysis is valid for frequencies greater than 100 Hz and assumes relatively flat noise, above 10 kHz. For lower frequencies, flicker noise ($1/f$) must be considered.

CHANNEL SEPARATION

Channel separation, or inverse crosstalk, is a measure of the signal feed from one amplifier (channel) to another on the same IC.

The AD8606 has a channel separation of greater than -160 dB up to frequencies of 1 MHz, allowing the two amplifiers to amplify ac signals independently in most applications.

CAPACITIVE LOAD DRIVE

The AD860x can drive large capacitive loads without oscillation.

Figure 47 shows the output of the AD8606 in response to a 200 mV input signal. In this case, the amplifier is configured in positive unity gain, worst case for stability, while driving a 1000 pF load at its output. Driving larger capacitive loads in unity gain can require the use of additional circuitry.

A snubber network, shown in Figure 48, helps reduce the signal overshoot to a minimum and maintain stability. Although this circuit does not recover the loss of bandwidth induced by large capacitive loads, it greatly reduces the overshoot and ringing. This method does not reduce the maximum output swing of the amplifier.

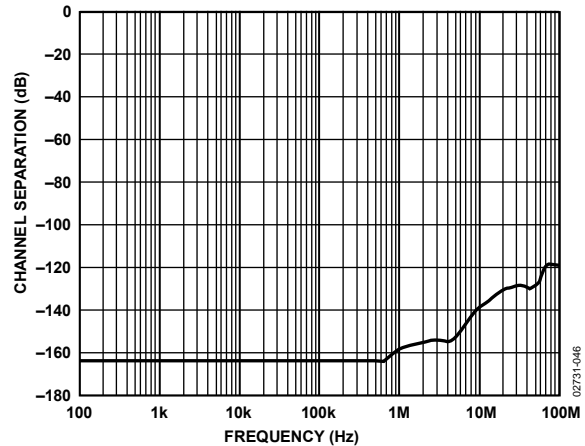

Figure 46. Channel Separation vs. Frequency

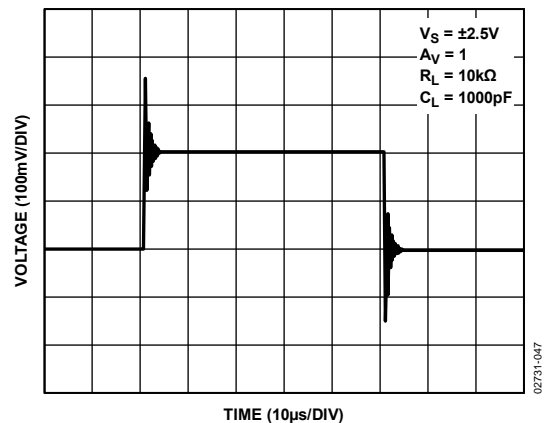

Figure 47. AD8606 Capacitive Load Drive Without Snubber

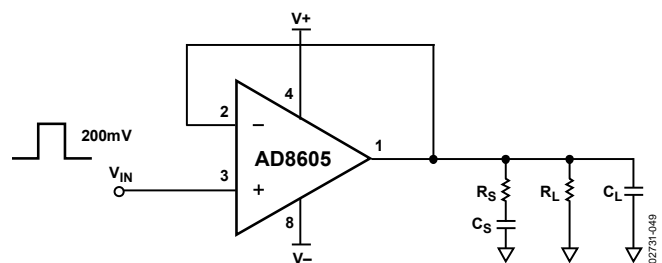

Figure 48. Snubber Network Configuration

Figure 49 shows a scope of the output at the snubber circuit. The overshoot is reduced from over 70% to less than 5%, and the ringing is eliminated by the snubber. Optimum values for R_s and C_s are determined experimentally.

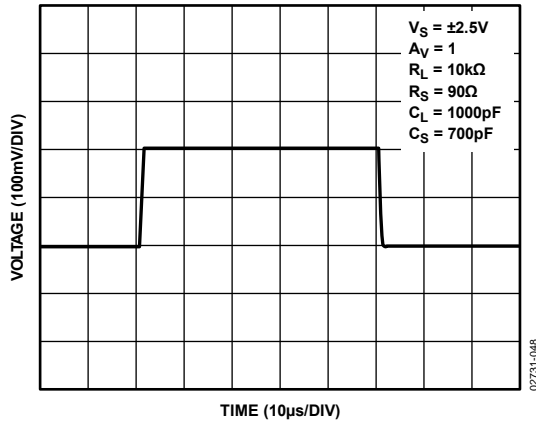

Figure 49. Capacitive Load Drive with Snubber

Table 5 summarizes a few optimum values for capacitive loads.

Table 5.

| C_L (pF) | R_S (Ω) | C_S (pF) |
|------------|--------------------|------------|
| 500 | 100 | 1000 |
| 1000 | 70 | 1000 |
| 2000 | 60 | 800 |

An alternate technique is to insert a series resistor inside the feedback loop at the output of the amplifier. Typically, the value of this resistor is approximately 100 Ω . This method also reduces overshoot and ringing but causes a reduction in the maximum output swing.

LIGHT SENSITIVITY

The AD8605ACB (WLCSP package option) is essentially a silicon die with additional postfabrication dielectric and intermetallic processing designed to contact solder bumps on the active side of the chip. With this package type, the die is exposed to ambient light and is subject to photoelectric effects. Light sensitivity analysis of the AD8605ACB mounted on standard PCB material reveals that only the input bias current (I_B) parameter is impacted when the package is illuminated directly by high intensity light. No degradation in electrical performance is observed due to illumination by low intensity (0.1 mW/cm²) ambient light. Figure 50 shows that I_B increases with increasing wavelength and intensity of incident light; I_B can reach levels as high as 4500 pA at a light intensity of 3 mW/cm² and a wavelength of 850 nm. The light intensities shown in Figure 50 are not normal for most applications, that is, even though direct sunlight can have intensities of 50 mW/cm², office ambient light can be as low as 0.1 mW/cm².

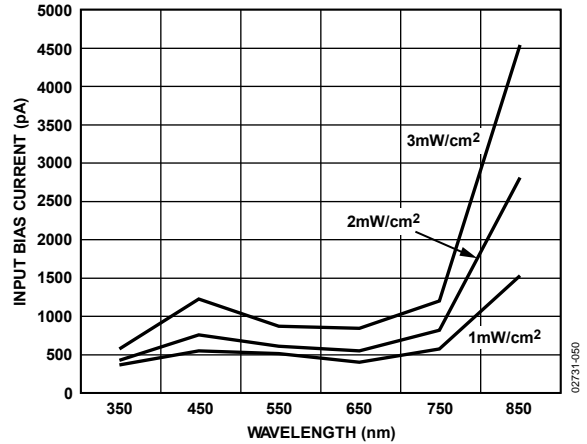

Figure 50. AD8605ACB Input Bias Current Response to Direct Illumination of Varying Intensity and Wavelength

When the WLCSP package is assembled on the board with the bump side of the die facing the PCB, reflected light from the PCB surface is incident on active silicon circuit areas and results in the increased I_B . No performance degradation occurs due to illumination of the backside (substrate) of the AD8605ACB. The AD8605ACB is particularly sensitive to incident light with wavelengths in the near infrared range (NIR, 700 nm to 1000 nm). Photons in this waveband have a longer wavelength and lower energy than photons in the visible (400 nm to 700 nm) and near ultraviolet (NUV, 200 nm to 400 nm) bands; therefore, they can penetrate more deeply into the active silicon. Incident light with wavelengths greater than 1100 nm has no photoelectric effect on the AD8605ACB because silicon is transparent to wavelengths in this range. The spectral content of conventional light sources varies. Sunlight has a broad spectral range, with peak intensity in the visible band that falls off in the NUV and NIR bands; fluorescent lamps have significant peaks in the visible but not the NUV or NIR bands.

Efforts have been made at a product level to reduce the effect of ambient light; the under bump metal (UBM) has been designed to shield the sensitive circuit areas on the active side (bump side) of the die. However, if an application encounters any light sensitivity with the AD8605ACB, shielding the bump side of the WLCSP package with opaque material should eliminate this effect. Shielding can be accomplished using materials such as silica-filled liquid epoxies that are used in flip-chip underfill techniques.

WLCSP ASSEMBLY CONSIDERATIONS

For detailed information on the WLCSP PCB assembly and reliability, see Application Note AN-617, *MicroCSP™ Wafer Level Chip Scale Package*.

I-V CONVERSION APPLICATIONS

PHOTODIODE PREAMPLIFIER APPLICATIONS

The low offset voltage and input current of the AD8605 make it an excellent choice for photodiode applications. In addition, the low voltage and current noise make the amplifier ideal for application circuits with high sensitivity.

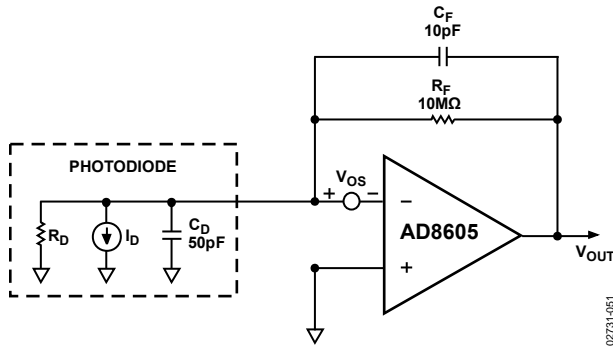

Figure 51. Equivalent Circuit for Photodiode Preamp

The input bias current of the amplifier contributes an error term that is proportional to the value of R_F .

The offset voltage causes a dark current induced by the shunt resistance of the Diode R_D . These error terms are combined at the output of the amplifier. The error voltage is written as

$$E_O = V_{OS} \left(1 + \frac{R_F}{R_D} \right) + R_F I_B$$

Typically, R_F is smaller than R_D , thus R_F/R_D can be ignored.

At room temperature, the AD8605 has an input bias current of 0.2 pA and an offset voltage of 100 μ V. Typical values of R_D are in the range of 1 G Ω .

For the circuit shown in Figure 51, the output error voltage is approximately 100 μ V at room temperature, increasing to about 1 mV at 85°C.

The maximum achievable signal bandwidth is

$$f_{MAX} = \sqrt{\frac{f_t}{2\pi R_F C_F}}$$

where f_t is the unity gain frequency of the amplifier.

AUDIO AND PDA APPLICATIONS

The low distortion and wide dynamic range of the AD860x make it a great choice for audio and PDA applications, including microphone amplification and line output buffering.

Figure 52 shows a typical application circuit for headphone/line-out amplification.

R_1 and R_2 are used to bias the input voltage at half the supply, which maximizes the signal bandwidth range. C_1 and C_2 are used to ac couple the input signal. C_1 , R_1 , and R_2 form a high-pass filter whose corner frequency is $1/[2\pi(R_1||R_2)C_1]$.

The high output current of the AD8606 allows it to drive heavy resistive loads.

The circuit in Figure 52 is tested to drive a 16 Ω headphone. The THD + N is maintained at approximately -60 dB throughout the audio range.

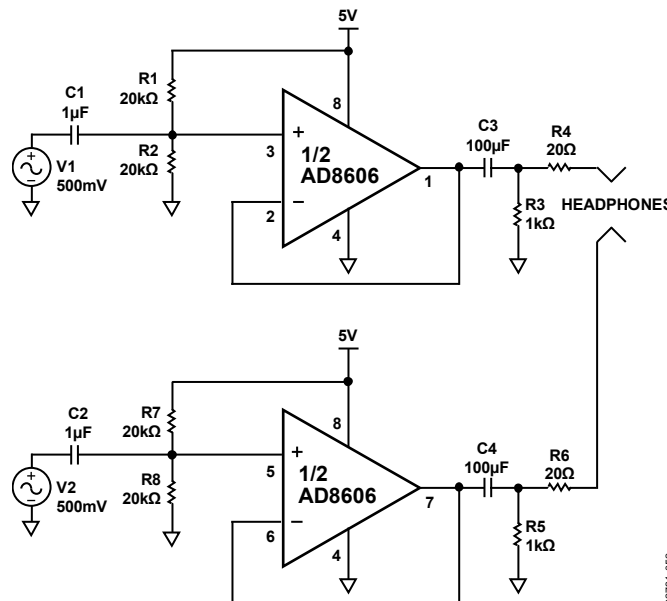

Figure 52. Single-Supply Headphone/Speaker Amplifier

INSTRUMENTATION AMPLIFIERS

The low offset voltage and low noise of the AD8605 make it an ideal amplifier for instrumentation applications.

Difference amplifiers are widely used in high accuracy circuits to improve the common-mode rejection ratio. Figure 53 shows a simple difference amplifier. Figure 54 shows the common-mode rejection for a unity gain configuration and for a gain of 10.

Making $(R4/R3) = (R2/R1)$ and choosing 0.01% tolerance yields a CMRR of 74 dB and minimizes the gain error at the output.

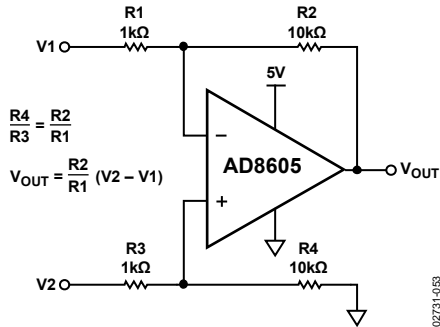

Figure 53. Difference Amplifier, $A_v = 10$

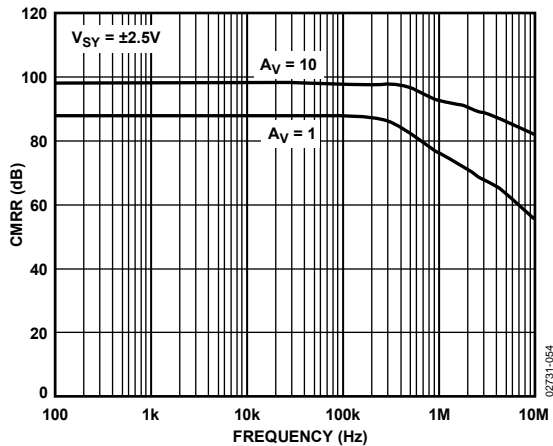

Figure 54. Difference Amplifier CMRR vs. Frequency

DAC CONVERSION

The low input bias current and offset voltage of the AD8605 make it an excellent choice for buffering the output of a current output DAC.

Figure 55 shows a typical implementation of the AD8605 at the output of a 12-bit DAC.

The DAC8143 output current is converted to a voltage by the feedback resistor. The equivalent resistance at the output of the DAC varies with the input code, as does the output capacitance.

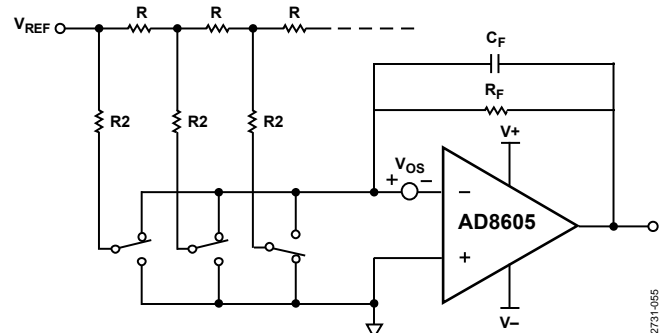

Figure 55. Simplified Circuit of the DAC8143 with AD8605 Output Buffer

To optimize the performance of the DAC, insert a capacitor in the feedback loop of the AD8605 to compensate the amplifier for the pole introduced by the output capacitance of the DAC. Typical values for C_F range from 10 pF to 30 pF; it can be adjusted for the best frequency response. The total error at the output of the op amp can be computed by

$$E_o = V_{os} \left(1 + \frac{R_F}{Req} \right)$$

where Req is the equivalent resistance seen at the output of the DAC. As previously mentioned, Req is code dependent and varies with the input. A typical value for Req is 15 kΩ. Choosing a feedback resistor of 10 kΩ yields an error of less than 200 μV.

Figure 56 shows the implementation of a dual-stage buffer at the output of a DAC. The first stage is used as a buffer. Capacitor C_1 with Req creates a low-pass filter, and thus, provides phase lead to compensate for frequency response. The second stage of the AD8606 is used to provide voltage gain at the output of the buffer.

Grounding the positive input terminals in both stages reduces errors due to the common-mode output voltage. Choosing R_1 , R_2 , and R_3 to match within 0.01% yields a CMRR of 74 dB and maintains minimum gain error in the circuit.

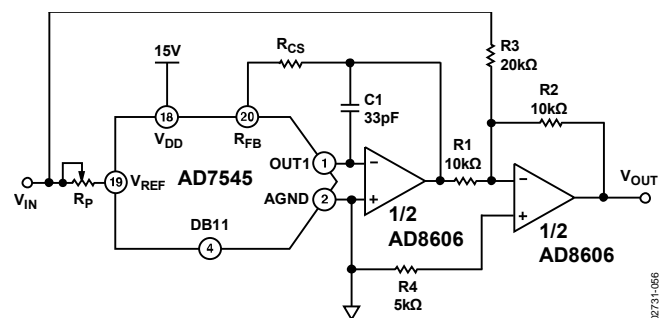

Figure 56. Bipolar Operation

OUTLINE DIMENSIONS

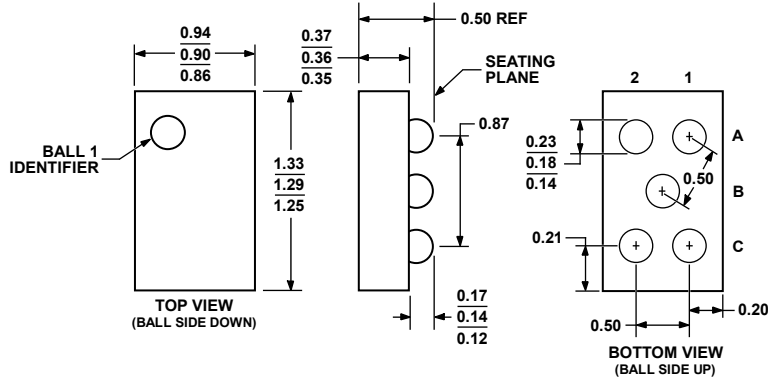
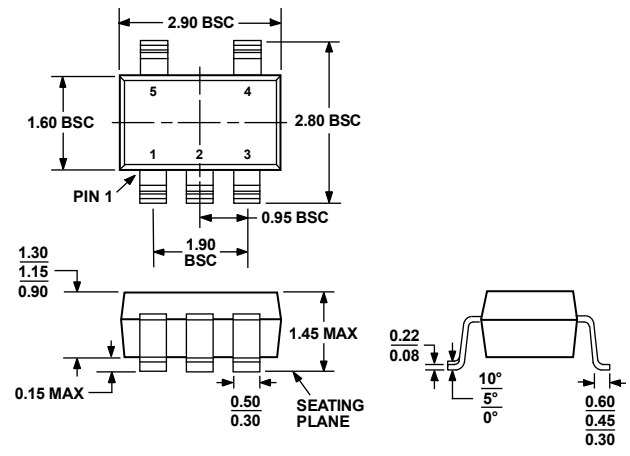
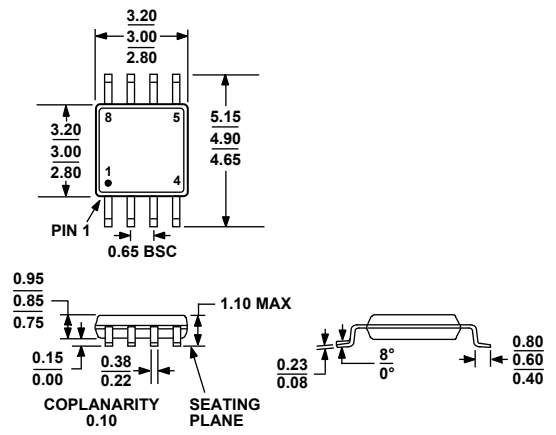

Figure 57. 5-Ball Wafer Level Chip Scale Package [WLCSP] (CB-5-1)
Dimensions shown in millimeters

101687-A



COMPLIANT TO JEDEC STANDARDS MO-178-AA
Figure 58. 5-Lead Small Outline Transistor Package [SOT-23] (RJ-5)
Dimensions shown in millimeters



COMPLIANT TO JEDEC STANDARDS MO-187-AA
Figure 59. 8-Lead Mini Small Outline Package [MSOP] (RM-8)
Dimensions shown in millimeters

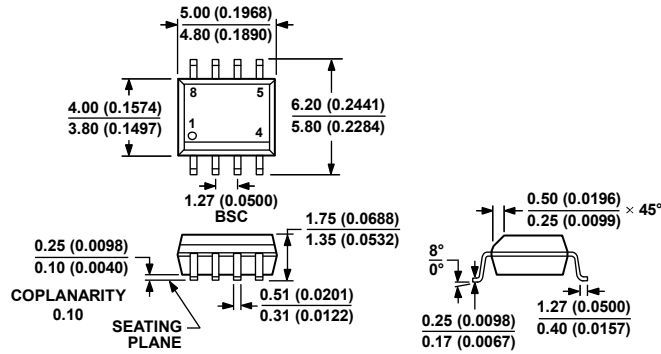

COMPLIANT TO JEDEC STANDARDS MS-012-AA
 CONTROLLING DIMENSIONS ARE IN MILLIMETERS; INCH DIMENSIONS
 (IN PARENTHESES) ARE ROUNDED-OFF MILLIMETER EQUIVALENTS FOR
 REFERENCE ONLY AND ARE NOT APPROPRIATE FOR USE IN DESIGN.

012407-A

Figure 60. 8-Lead Standard Small Outline Package [SOIC_N]
 Narrow Body (R-8)
 Dimensions shown in millimeters and (inches)

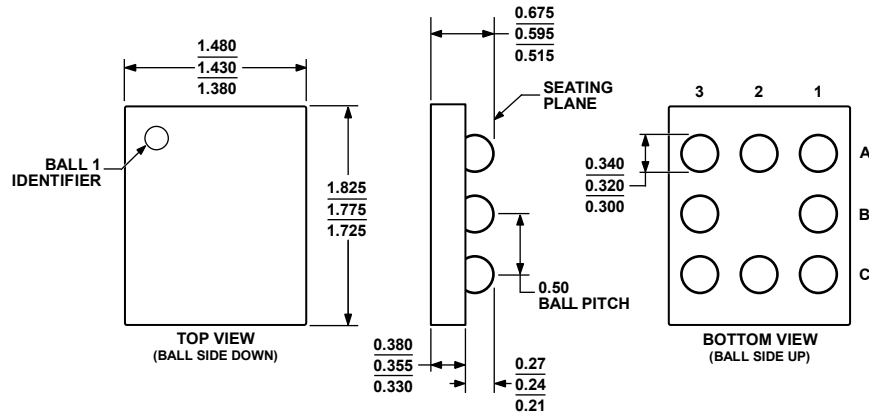

090706-B

Figure 61. 8-Ball Wafer Level Chip Scale Package [WLCSP]
 (CB-8-1)
 Dimensions shown in millimeters

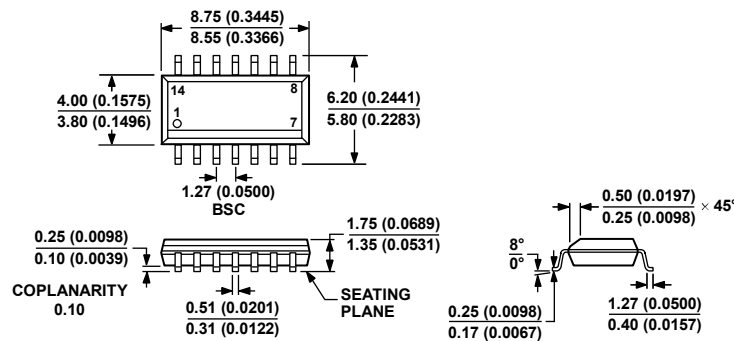

COMPLIANT TO JEDEC STANDARDS MS-012-AB
 CONTROLLING DIMENSIONS ARE IN MILLIMETERS; INCH DIMENSIONS
 (IN PARENTHESES) ARE ROUNDED-OFF MILLIMETER EQUIVALENTS FOR
 REFERENCE ONLY AND ARE NOT APPROPRIATE FOR USE IN DESIGN.

060606-A

Figure 62. 14-Lead Standard Small Outline Package [SOIC_N]
 Narrow Body (R-14)
 Dimensions shown in millimeters and (inches)

AD8605/AD8606/AD8608

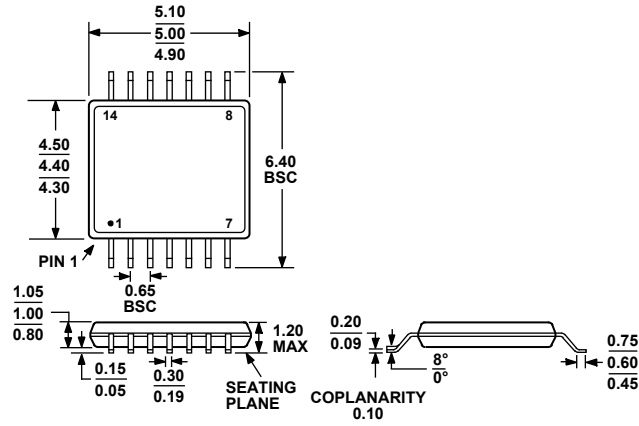

COMPLIANT TO JEDEC STANDARDS MO-153-AB-1
 Figure 63. 14-Lead Thin Shrink Small Outline Package [TSSOP]
 (RU-14)
 Dimensions shown in millimeters

ORDERING GUIDE

| Model | Temperature Range | Package Description | Package Option | Branding |
|-------------------------------|-------------------|---------------------|----------------|----------|
| AD8605ACB-REEL | -40°C to +125°C | 5-Ball WLCSP | CB-5-1 | B3A |
| AD8605ACB-REEL7 | -40°C to +125°C | 5-Ball WLCSP | CB-5-1 | B3A |
| AD8605ACBZ-REEL ¹ | -40°C to +125°C | 5-Ball WLCSP | CB-5-1 | A1J |
| AD8605ACBZ-REEL7 ¹ | -40°C to +125°C | 5-Ball WLCSP | CB-5-1 | A1J |
| AD8605ART-R2 | -40°C to +125°C | 5-Lead SOT-23 | RJ-5 | B3A |
| AD8605ART-REEL | -40°C to +125°C | 5-Lead SOT-23 | RJ-5 | B3A |
| AD8605ART-REEL7 | -40°C to +125°C | 5-Lead SOT-23 | RJ-5 | B3A |
| AD8605ARTZ-R2 ¹ | -40°C to +125°C | 5-Lead SOT-23 | RJ-5 | B3A# |
| AD8605ARTZ-REEL ¹ | -40°C to +125°C | 5-Lead SOT-23 | RJ-5 | B3A# |
| AD8605ARTZ-REEL7 ¹ | -40°C to +125°C | 5-Lead SOT-23 | RJ-5 | B3A# |
| AD8606ARM-R2 | -40°C to +125°C | 8-Lead MSOP | RM-8 | B6A |
| AD8606ARM-REEL | -40°C to +125°C | 8-Lead MSOP | RM-8 | B6A |
| AD8606ARMZ-R2 ¹ | -40°C to +125°C | 8-Lead MSOP | RM-8 | B6A# |
| AD8606ARMZ-REEL ¹ | -40°C to +125°C | 8-Lead MSOP | RM-8 | B6A# |
| AD8606AR | -40°C to +125°C | 8-Lead SOIC_N | R-8 | |
| AD8606AR-REEL | -40°C to +125°C | 8-Lead SOIC_N | R-8 | |
| AD8606AR-REEL7 | -40°C to +125°C | 8-Lead SOIC_N | R-8 | |
| AD8606ARZ ¹ | -40°C to +125°C | 8-Lead SOIC_N | R-8 | |
| AD8606ARZ-REEL ¹ | -40°C to +125°C | 8-Lead SOIC_N | R-8 | |
| AD8606ARZ-REEL7 ¹ | -40°C to +125°C | 8-Lead SOIC_N | R-8 | |
| AD8606ACBZ-REEL ¹ | -40°C to +125°C | 8-Ball WLCSP | CB-8-1 | B6A# |
| AD8606ACBZ-REEL7 ¹ | -40°C to +125°C | 8-Ball WLCSP | CB-8-1 | B6A# |
| AD8608AR | -40°C to +125°C | 14-Lead SOIC_N | R-14 | |
| AD8608AR-REEL | -40°C to +125°C | 14-Lead SOIC_N | R-14 | |
| AD8608AR-REEL7 | -40°C to +125°C | 14-Lead SOIC_N | R-14 | |
| AD8608ARZ ¹ | -40°C to +125°C | 14-Lead SOIC_N | R-14 | |
| AD8608ARZ-REEL ¹ | -40°C to +125°C | 14-Lead SOIC_N | R-14 | |
| AD8608ARZ-REEL7 ¹ | -40°C to +125°C | 14-Lead SOIC_N | R-14 | |
| AD8608ARU | -40°C to +125°C | 14-Lead TSSOP | RU-14 | |
| AD8608ARU-REEL | -40°C to +125°C | 14-Lead TSSOP | RU-14 | |
| AD8608ARUZ ¹ | -40°C to +125°C | 14-Lead TSSOP | RU-14 | |
| AD8608ARUZ-REEL ¹ | -40°C to +125°C | 14-Lead TSSOP | RU-14 | |

¹ Z = RoHS Compliant Part, # denotes RoHS compliant (except for CB-5-1). Product may be top or bottom marked.

NOTES

NOTES