

Panasonic
ideas for life

**HIGH ENVIRONMENTAL
RESISTANCE**

**TURQUOISE
SWITCHES
ABV TYPE**

FEATURES

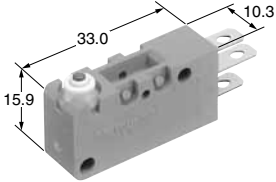

- **Miniature size (33×15.9×10.3 mm)**
- **Sealed construction for use in adverse environment**-Sealed construction by epoxy resin and rubber cap greatly reduces possible miscontact due to contaminants such as dust. Conforming to IP67* of IEC protective construction classification
- **Elastomer double molding technology, an industry first and ultrasonic swaging technology contribute to uniform sealing in high production quantities**
- **UL/CSA/VDE/SEMCO approved**

* Based on the protective construction classification of IED, items which satisfy the test requirements are denoted with an IP designation.



TYPICAL APPLICATIONS

- **Automotive**
- **Agricultural devices**
- **Industrial equipment**

ORDERING INFORMATION

Ex. **ABV1 2 1 0 6 1 3**

Type of switch	Terminal	Contact arrangement	Actuator	Operating force by pin plunger (max.)	Contact	Agency standard
ABV1: Turquoise switch V type	2: .187 quick-connect terminal 6: Wire leads	1: SPDT 2: SPST-NC 3: SPST-NO	0: Pin plunger 2: Hinge lever 4: Simulated roller lever 5: Short roller lever 6: Roller lever	4: 0.98 N 5: 1.96 N	0: AgNi alloy 1: AgNi alloy + Au clad	3: UL/CSA/VDE/ SEMCO

Remarks: 1. Standard packing: Dust protected type 50 pcs./carton, 500 pcs./case; Immersion protected type 50 pcs./case.
2. Not every combination is available. Please refer to the following table, "PRODUCT TYPES".

CONSTRUCTION

.187 quick-connect terminal

Wire leads

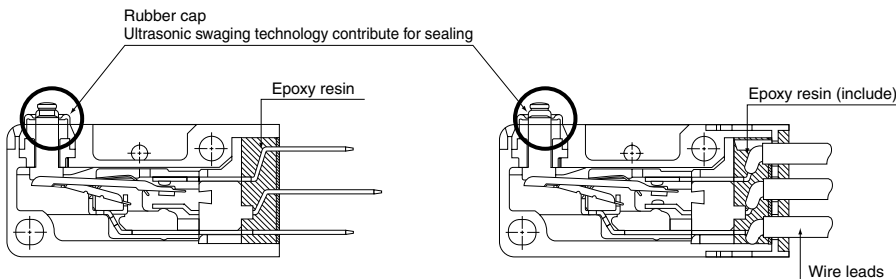

APPLICABLE CURRENT RANGE (Reference only)

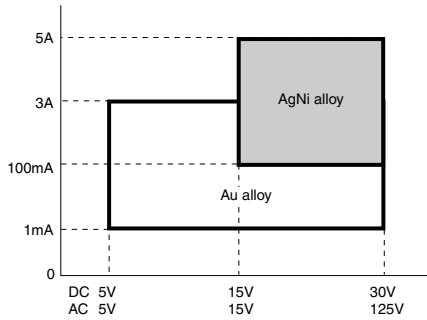

PRODUCT TYPES

AgNi alloy

Contact	Actuator	Contact Arrangement	Operating force, Max.	187 Quick-connect terminal	Wire Leads
AgNi alloy	Pin plunger	SPDT	0.98 N	ABV1210403	ABV1610403
			1.96 N	ABV1210503	ABV1610503
		SPST-NC	0.98 N	ABV1220403	ABV1620403
			1.96 N	ABV1220503	ABV1620503
		SPST-NO	0.98 N	ABV1230403	ABV1630403
			1.96 N	ABV1230503	ABV1630503
	Hinge lever	SPDT	0.59 N	ABV1212403	ABV1612403
			1.18 N	ABV1212503	ABV1612503
		SPST-NC	0.59 N	ABV1222403	ABV1622403
			1.18 N	ABV1222503	ABV1622503
		SPST-NO	0.59 N	ABV1232403	ABV1632403
			1.18 N	ABV1232503	ABV1632503
	Simulated roller lever	SPDT	0.59 N	ABV1214403	ABV1614403
			1.18 N	ABV1214503	ABV1614503
		SPST-NC	0.59 N	ABV1224403	ABV1624403
			1.18 N	ABV1224503	ABV1624503
		SPST-NO	0.59 N	ABV1234403	ABV1634403
			1.18 N	ABV1234503	ABV1634503
	Short roller lever	SPDT	1.08 N	ABV1215403	ABV1615403
			2.16 N	ABV1215503	ABV1615503
		SPST-NC	1.08 N	ABV1225403	ABV1625403
			2.16 N	ABV1225503	ABV1625503
		SPST-NO	1.08 N	ABV1235403	ABV1635403
			2.16 N	ABV1235503	ABV1635503
Roller lever	SPDT	0.59 N	ABV1216403	ABV1616403	
		1.18 N	ABV1216503	ABV1616503	
	SPST-NC	0.59 N	ABV1226403	ABV1626403	
		1.18 N	ABV1226503	ABV1626503	
	SPST-NO	0.59 N	ABV1236403	ABV1636403	
		1.18 N	ABV1236503	ABV1636503	

ABV1

AgNi alloy + Au clad

Contact	Actuator	Contact Arrangement	Operating force, Max.	187 Quick-connect terminal	Wire Leads
AgNi alloy + Au clad	Pin plunger	SPDT	0.98 N	ABV1210413	ABV1610413
			1.96 N	ABV1210513	ABV1610513
		SPST-NC	0.98 N	ABV1220413	ABV1620413
			1.96 N	ABV1220513	ABV1620513
		SPST-NO	0.98 N	ABV1230413	ABV1630413
			1.96 N	ABV1230513	ABV1630513
	Hinge lever	SPDT	0.59 N	ABV1212413	ABV1612413
			1.18 N	ABV1212513	ABV1612513
		SPST-NC	0.59 N	ABV1222413	ABV1622413
			1.18 N	ABV1222513	ABV1622513
		SPST-NO	0.59 N	ABV1232413	ABV1632413
			1.18 N	ABV1232513	ABV1632513
	Simulated roller lever	SPDT	0.59 N	ABV1214413	ABV1614413
			1.18 N	ABV1214513	ABV1614513
		SPST-NC	0.59 N	ABV1224413	ABV1624413
			1.18 N	ABV1224513	ABV1624513
		SPST-NO	0.59 N	ABV1234413	ABV1634413
			1.18 N	ABV1234513	ABV1634513
	Short roller lever	SPDT	1.08 N	ABV1215413	ABV1615413
			2.16 N	ABV1215513	ABV1615513
		SPST-NC	1.08 N	ABV1225413	ABV1625413
			2.16 N	ABV1225513	ABV1625513
		SPST-NO	1.08 N	ABV1235413	ABV1635413
			2.16 N	ABV1235513	ABV1635513
Roller lever	SPDT	0.59 N	ABV1216413	ABV1616413	
		1.18 N	ABV1216513	ABV1616513	
	SPST-NC	0.59 N	ABV1226413	ABV1626413	
		1.18 N	ABV1226513	ABV1626513	
	SPST-NO	0.59 N	ABV1236413	ABV1636413	
		1.18 N	ABV1236513	ABV1636513	

SPECIFICATIONS

1. Contact rating

Type	Standard rating	Low-level rating
AgNi alloy + Au clad contact	3 A 250 V AC (O.F. 1.96 N) 1 A 250 V AC (O.F. 0.98 N)	5 mA 6 V DC 2 mA 12 V DC 1 mA 24 V DC
AgNi alloy	5 A 250 V AC (O.F. 1.96 N) 3 A 250 V AC (O.F. 0.98 N)	—

2. Characteristics

Mechanical life (O.T.: Specified value)	Min. 5x10 ⁶ (at 60 cpm)	
Electrical life	Nominal rating (O.T.: Max.)	Min. 10 ⁵ (at 20 cpm)* ¹
	Low-level rating (O.T.: Specified value)	Min. 10 ⁶ (at 20 cpm)
Insulation resistance	Min. 100 MΩ (at 500 V DC insulation resistance meter)	
Dielectric strength		
Between non-continuous terminals	1,000 Vrms	
Between each terminal and other exposed metal parts	2,000 Vrms	
Between each terminal and ground	2,000 Vrms	
Vibration resistance	10 to 55 Hz at single amplitude of 0.75 mm (Contact opening: max. 1 msec.)	
Shock resistance	Min. 294 m/s ² (Contact opening: Max. 1 msec.)	
Contact resistance	AgNi alloy contact type	Dust protected type (IP50): Max. 50 mΩ Immersion protected type (IP67): Max. 100 mΩ (By voltage drop 1 A 6 to 8 V DC)
	AgNi alloy + Au clad contact type	Dust protected type (IP50): Max. 50 mΩ Immersion protected type (IP67): Max. 100 mΩ (By voltage drop 0.1 A 6 to 8 V DC)
Allowable operating speed (at no load)	1 to 500 mm/sec.	
Max. operating cycle rate (at no load)	120 cpm	
Ambient temperature (at no load)	-40°C to +85°C	
Unit weight	Approx. 7 g (IP50 type)	

Note: *1 O.F. 0.98N type is Min 5 × 10⁶ (at 20 com)

3. Operating characteristics

Type of actuator	Operating force, Max.		Release force, Min.		Pretravel, Max. mm	Movement differential, Max. mm	Overtravel, Min. mm	Operating position, mm
	1.96N	0.98N	0.39N	0.25N				
Pin plunger	1.96N	0.98N	0.39N	0.25N	1.6	0.4	0.8	14.7±0.6
Hinge lever	1.18N	0.59N	0.13N	0.098N	3.2	1.2	1.2	15.3±1.2
Simulated roller lever	1.18N	0.59N	0.13N	0.098N	3.2	1.2	1.2	18.5±1.2
Short roller lever	2.16N	1.08N	0.39N	0.20N	1.6	0.5	0.8	20.7±0.8
Roller lever	1.18N	0.59N	0.13N	0.098N	3.2	1.2	1.2	20.7±1.2

() : Low force type

DIMENSIONS

mm General tolerance: ±0.4

1. Dust protected type

1-(1) .187 quick-connect terminal

Pin plunger

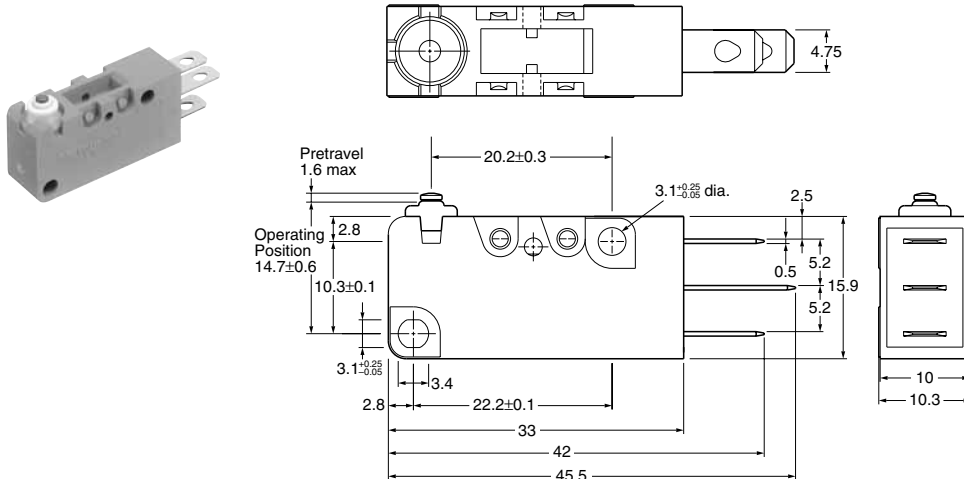

ABV1

Hinge lever

mm General tolerance: ± 0.25

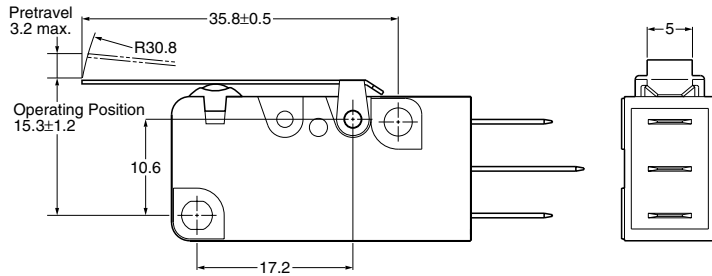

Pretravel, Max. mm	3.2
Movement differential, Max. mm	1.2
Overtravel, Min. mm	1.2
Operating position, mm	15.3±1.2

Simulated roller lever

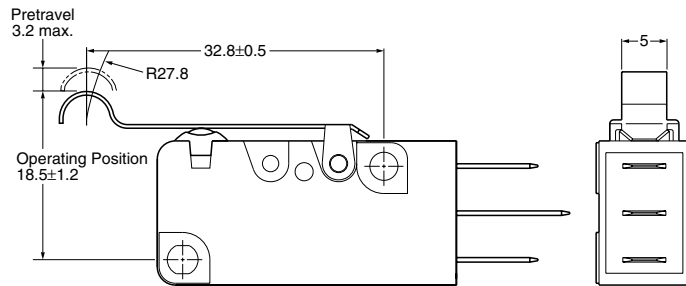

Pretravel, Max. mm	3.2
Movement differential, Max. mm	1.2
Overtravel, Min. mm	1.2
Operating position, mm	18.5±1.2

Short roller lever

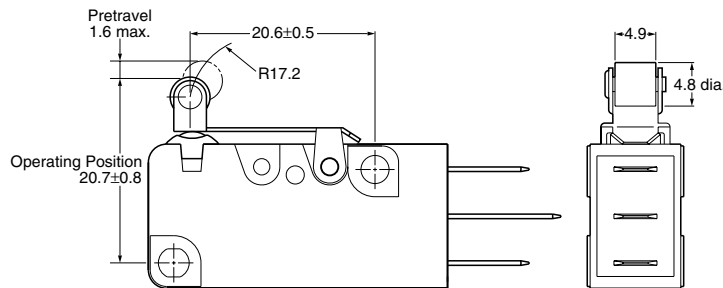
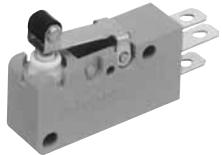

Pretravel, Max. mm	1.6
Movement differential, Max. mm	0.5
Overtravel, Min. mm	0.8
Operating position, mm	20.7±0.8

Roller lever

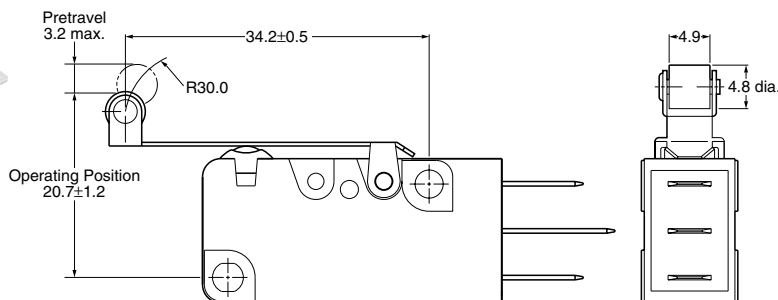

Pretravel, Max. mm	3.2
Movement differential, Max. mm	1.2
Overtravel, Min. mm	1.2
Operating position, mm	20.7±1.2

2. Immersion protected type

Wire Leads

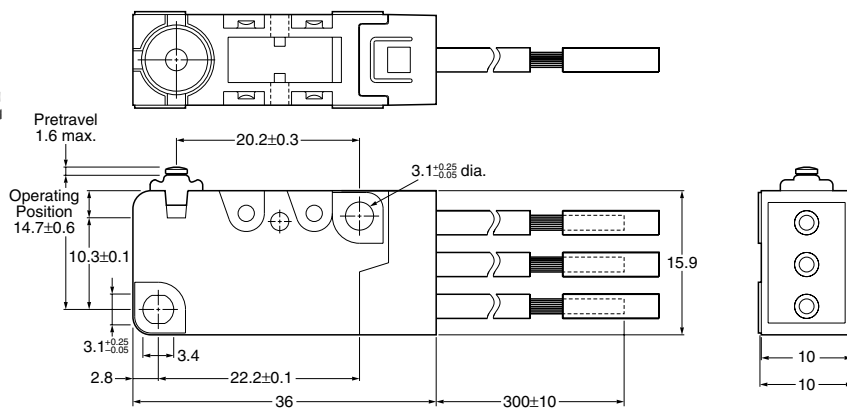

Thickness of the lead wire:
 Standard type: 0.75mm²
 UL/CSA approved type:
 AWG #18
 Color of the lead wire
 COM ...black
 N.C.red
 N.O.white