

## CryptoAuthentication Ensures Things and Code are Real, Untampered, and Confidential



### Secure Download and Boot

Authentication and Protect Code  
In-transit

### Ecosystem Control

Ensure Only OEM/Licensed  
Nodes and Accessories Work

### Anti-cloning

Prevent Building with Identical  
BOM or Stolen Code

### Message Security

Authentication, Message Integrity,  
and Confidentiality of Network  
Nodes (IoT)

## Features

- Crypto Element with Protected Hardware-based Key Storage
- Secure Symmetric Authentication Device Host and Client Operations
- Superior SHA-256 Hash Algorithm with Message Authentication Code (MAC) and Hash-Based Message Authentication Code (HMAC) Options
- Best-in-class, 256-bit Key Length; Storage for Up to 16 Keys
- Guaranteed Unique 72-bit Serial Number
- Internal, High-quality Random Number Generator (RNG)
- 4.5Kb EEPROM for Keys and Data
- 512 bit OTP (One Time Programmable) Bits for Fixed Information
- Multiple I/O Options
  - UART-compatible High-Speed, Single-Wire Interface
  - 1MHz I<sup>2</sup>C Interface
- 2.0V to 5.5V Supply Voltage Range
- 1.8V to 5.5V Communications Voltage Range
- <150nA Sleep Current
- Secure Download and Boot
  - Ecosystem Control
  - Message Security
  - Anti-Cloning
- 8-lead SOIC, 8-lead TSSOP<sup>(2)</sup>, 3-lead SOT23, 8-pad UDFN, 8-pad XDFN, and 3-lead CONTACT Packages

## Applications

- Secure Download and Boot
- Ecosystem Control
- Anti-cloning
- Message Security

**Table 1. Pin Configurations**

Pin Name	Function
NC	No Connect
GND	Ground
SDA	Serial Data
SCL	Serial Clock Input
V <sub>CC</sub>	Power Supply

**Figure 1. Pinouts<sup>(1)</sup>**

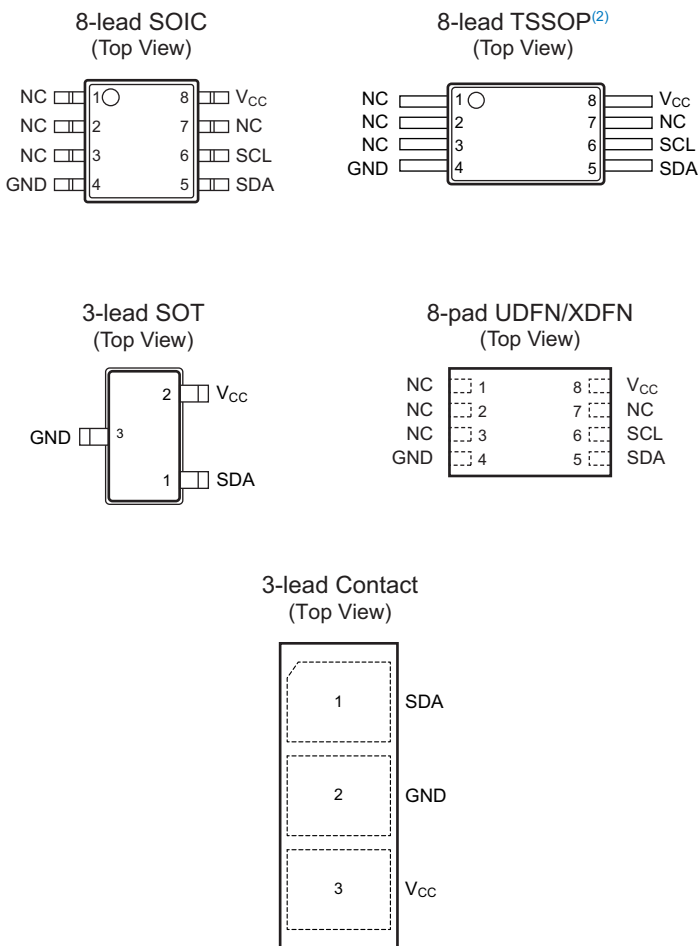

- Notes: 1. Drawings are not to scale.  
 2. Not recommended for new design.

## Table of Contents

---

<b>1. Introduction</b>	6
1.1 Applications	6
1.2 Device Features	6
1.3 Cryptographic Operation	7
<b>2. Device Organization</b>	9
2.1 EEPROM Organization	9
2.1.1 Data Zone	9
2.1.2 Configuration Zone	10
2.1.3 One Time Programmable (OTP) Zone	14
2.1.4 Device Locking	16
2.2 Static RAM (SRAM)	17
2.2.1 TempKey	17
<b>3. Security Features</b>	18
3.1 Physical Security	18
3.2 Random Number Generator (RNG)	18
<b>4. General I/O Information</b>	19
4.1 Byte and Bit Ordering	19
4.1.1 Output Example	19
4.1.2 MAC Message Example	19
<b>5. Single-Wire Interface</b>	20
5.1 I/O Tokens	21
5.2 I/O Flags	21
5.2.1 Transmit Flag	22
5.3 Synchronization	22
5.3.1 I/O Timeout	22
5.3.2 Synchronization Procedures	22
5.4 Sharing the Interface	23
5.5 Transaction Example	24
5.6 Wiring Configuration for Single-Wire Interface	25
5.6.1 2-lead Configuration	25
<b>6. I<sup>2</sup>C Interface</b>	27
6.1 I/O Conditions	27
6.1.1 Device is Asleep	27
6.1.2 Device is Awake	27
6.2 I <sup>2</sup> C Transmission to the ATSHA204A Device	29
6.2.1 Word Address Values	30
6.2.2 Command Completion Polling	30
6.3 I <sup>2</sup> C Transmission from the ATSHA204A Device	30
6.4 Address Counter	31
6.5 I <sup>2</sup> C Synchronization	31
6.6 Transaction Example	32

<b>7. Electrical Characteristics</b>	33
7.1 Absolute Maximum Ratings	33
7.2 Reliability	33
7.3 AC Parameters — All I/O Interfaces	33
7.3.1 AC Parameters — Single-Wire Interface	34
7.3.2 AC Parameters — I <sup>2</sup> C Interface	36
7.4 DC Parameters — All I/O Interfaces	37
7.4.1 V <sub>IH</sub> and V <sub>IL</sub> Specifications	37
<b>8. Security Commands</b>	39
8.1 I/O Blocks	39
8.1.1 Status/Error Codes	39
8.2 Sleep Sequence	40
8.3 Idle Sequence	40
8.4 Watchdog Failsafe	41
8.5 Command Sequence	41
8.5.1 Command Packets	41
8.5.2 Command Opcodes, Short Descriptions, and Execution Times	42
8.5.3 Zone Encoding	43
8.5.4 Address Encoding	44
<b>8.5.5 CheckMac Command</b>	45
8.5.6 DeriveKey Command	47
8.5.7 DevRev Command	49
8.5.8 GenDig Command	50
8.5.9 HMAC Command	52
8.5.10 Lock Command	54
8.5.11 MAC Command	55
8.5.12 Nonce Command	57
8.5.13 Pause Command	59
8.5.14 Random Command	60
8.5.15 Read Command	61
8.5.16 SHA Command	63
8.5.17 UpdateExtra Command	64
8.5.18 Write Command	65
<b>9. Compatibility</b>	67
<b>10. Mechanical</b>	68
10.1 Pinout	68
<b>11. Package Drawings</b>	69
11.1 8-lead SOIC	69
11.2 8-lead TSSOP	70
11.3 3-lead SOT23	71
11.4 8-pad UDFN	72
11.5 8-pad XDFN	73
11.6 3-lead CONTACT	74
<b>12. Ordering Information</b>	75

<b>13. Reference and Application Notes</b>	76
13.1 SHA-256	76
13.2 HMAC/SHA-256	76
13.3 Key Values	76
13.3.1 Diversified Keys	77
13.3.2 Rolled Keys	77
13.3.3 Created Keys	77
13.3.4 Single-use Keys	78
13.3.5 Limited-use Key	78
13.3.6 Password Checking	79
13.3.7 Transport Keys	80
<b>14. Revision History</b>	81

# 1. Introduction

The following sections introduce the features and functions of the Atmel® ATSHA204A crypto element device.

## 1.1 Applications

The ATSHA204A is a member of the Atmel CryptoAuthentication™ family of high-security hardware authentication devices. It has a flexible command set that allows use in many applications, including the following, among others:

- **Anti-counterfeiting**  
Validating that a removable, replaceable, or consumable Client is authentic. Example Clients could be printer ink tanks, electronic daughter cards, medical disposables, or spare parts. The device can also be used to validate (authenticate) a software/firmware module or memory storage element.
- **Protecting Firmware or Media**  
Validating code that is stored in flash memory at boot time to prevent unauthorized modifications (this is also known as secure boot), encrypt downloaded media files, and uniquely encrypt code images to be usable on a single system only.
- **Exchanging Session Keys**  
Securely and easily exchanging stream encryption keys for use by an encryption/decryption engine in the system microprocessor to manage a confidential communications channel, an encrypted download, and similar items.
- **Storing Data Securely**  
Storing secret keys for use by crypto accelerators in standard microprocessors. It can also be used to store small quantities of data necessary for configuration, calibration, ePurse value, consumption data, or other secrets. Programmable protection up through encrypted/authenticated reads and writes.
- **Checking User Passwords**  
Validating user-entered passwords without letting the expected value become known, mapping simple passwords to complex ones, and securely exchanging password values with remote systems.

## 1.2 Device Features

The ATSHA204A device includes an Electrically Erasable Programmable Read-Only Memory (EEPROM) array that can be used for key storage, miscellaneous read/write data, read-only, secret data, consumption logging, and security configuration. Access to the various sections of memory can be restricted in a variety of ways, and the configuration can then be locked to prevent changes. See [Section 2.1, “EEPROM Organization”](#) for details.

The ATSHA204A features a wide array of defense mechanisms specifically designed to prevent physical attacks on the device itself or logical attacks on the data transmitted between the device and the system see [Section 3., “Security Features”](#) for more details. Hardware restrictions on the way keys are used or generated provide further defense against certain styles of attack.

Access to the device is made through a standard I<sup>2</sup>C interface at speeds of up to 1Mb/s. see [Section 6., “I<sup>2</sup>C Interface”](#) for details. It is compatible with I<sup>2</sup>C interface specifications. The device also supports a Single-Wire Interface (SWI) that can reduce the number of GPIOs required on the system processor and/or reduce the number of pins on connectors. See [Section 5., “Single-Wire Interface”](#) for more details.

Using the Single-Wire Interface, multiple ATSHA204A devices can share the same bus, which saves processor GPIO usage in systems with multiple Clients such as different color ink tanks or multiple spare parts, as examples. See [Section 5.4, “Sharing the Interface”](#) and [Section 8.5.13, “Pause Command”](#) for details on how this is implemented.

Each ATSHA204A ships with a guaranteed unique 9-byte (72-bit) serial number. Using the cryptographic protocols supported by the device, a Host system or remote server can prove that the serial number is authentic and is not a copy. Serial numbers are often stored in a standard Serial EEPROM, which can be easily copied with no way for the Host to know if the serial number is authentic or if it is a clone. The entire serial number must be utilized to guarantee uniqueness.

The ATSHA204A can generate high-quality random numbers and employ them for any purpose, including as part of the crypto protocols of this device. Because each 32-byte (256-bit) random number is not dependent on past numbers generated on this or any other device, their inclusion in the protocol calculation ensures that replay attacks (i.e. re-transmitting a previously successful transaction) always fail. See [Section 3.2, “Random Number Generator \(RNG\)”](#) and [Section 8.5.14, “Random Command”](#).

System integration is made easy by a wide supply voltage range (of 2.0V through 5.5V) and an ultra-low sleep current (of <150nA). Complete DC parameters are found in [Section 7., “Electrical Characteristics”](#), which describes multiple package options, including a tiny UDFN package with a footprint of only 2.0mm x 3.0mm. See [Section 11., “Package Drawings”](#) for more details and ordering codes.

See [Section 9., “Compatibility”](#) for information regarding compatibility with the Atmel ATSHA204.

### 1.3 Cryptographic Operation

The ATSHA204A supports a standard challenge-response protocol to simplify programming. In its most basic installation, the Host system sends a challenge (i.e. a number) to the device in the Client, which combines that challenge with a secret key by using the Message Authentication Code (MAC) command from the system, as described in [Section 8.5.11, “MAC Command”](#), and sends that response back to the system. The device uses a cryptographic hash algorithm to make that combination (which is also known as a digest). The use of a hash algorithm prevents an observer on the bus from deriving the value of the secret key, while allowing the recipient to verify that the response is correct by performing the same calculation combining the challenge with the secret to create a digest using a stored copy of the secret.

This basic operation can be expanded in many ways because of the flexible command set of the ATSHA204A. By using the GenDig command ([Section 8.5.8, “GenDig Command”](#)), the values in other slots can be included in the response digest, which provides an effective way of proving that a data read really did come from the device, as opposed to being inserted by a man-in-the-middle attacker. This same command can be used to combine two keys with the challenge, which is useful when there are multiple layers of authentication to be performed.

The DeriveKey command ([Section 8.5.6, “DeriveKey Command”](#)) implements a key rolling scheme. Depending upon the command mode parameter, the resulting operation can be similar to that implemented in a remote-controlled garage door opener, for example. Each time the key is used, the current value of the key is cryptographically combined with a value specific to that system, and that result then forms the key for the next cryptographic operation. Even if an attacker obtains the value of one key, that key will disappear forever with the next use.

DeriveKey can also be used to generate new random keys that might be valid only for a particular Host ID, for a particular time period, or for some other restricted condition. Each generated key is different from any other key ever generated on any device. By “activating” a Host-Client pair in the field in this manner, a clone of a single Client will not work on any other Host.

In a Host-Client configuration where the Host (e.g. a mobile phone) needs to verify a Client (e.g. an OEM battery), there is a need to store the secret in the Host in order to validate the response from the Client. The CheckMac command ([Section 8.5.5, “CheckMac Command”](#)) allows the Host device to securely store the Client’s secret and hide the correct response value from the pins, returning only a yes/no answer to the system.

Where a user-entered password is required, the CheckMac command also provides a way to both verify the password without exposing it on the communications bus and map the password to a stored value that can have much higher entropy. See [Section 13.3.6, “Password Checking”](#) for details.

Finally, the hash combination (i.e. digest) of a challenge and secret key can be kept on the device and XORed with the contents of a slot to implement an encrypted read ([Section 8.5.15, “Read Command”](#)), or it can be XORed with encrypted input data to implement an encrypted write ([Section 8.5.18, “Write Command”](#)).

Each of these operations can be protected against replay attacks by including a random nonce ([Section 8.5.12, “Nonce Command”](#)) in the calculation.

All security functions are implemented using the industry-standard SHA-256 secure hash algorithm, which is part of the latest set of high-security cryptographic algorithms recommended by various government agencies and cryptographic experts. [Section 13.1, “SHA-256”](#) includes a reference to the algorithm details. If desired, the SHA-256 algorithm can also be included in an HMAC sequence (See [Section 8.5.9, “HMAC Command”](#)). The ATSHA204A employs full-sized, 256-bit secret keys to prevent any kind of exhaustive attack.



## 2. Device Organization

The device contains the following memory blocks:

- EEPROM
- SRAM

### 2.1 EEPROM Organization

The EEPROM contains a total of 664-bytes (5312-bits), and is divided into the following zones:

- **Data**  
A 512-byte (4Kb) zone split into 16 general-purpose, read-only, or read/write memory slots of 32 bytes (256 bits) each that can be used to store keys, calibration data, model number, or other information related to the item to which the ATSHA204A device is attached. Each slot may have different access restrictions based on the values stored in the Configuration zone. Within this document the nomenclature slot[yy] indicates the 32-byte value stored in slot yy of the Data zone.
- **Configuration**  
An 88-byte (704-bit) zone that contains serial number and other ID information as well as access permission information for each slot of the data memory. Within this document the nomenclature SN[a:b] indicates a range of bytes within a field of the configuration section. The 88-bytes are accessible from within a three-block address space.
- **OTP (One Time Programmable)**  
A 64-byte (512-bit) zone which can be used to store read-only data or one-way (fuse type) consumption logging information. Prior to locking the OTP zone, the bits may be freely written using the standard Write command. The OTP zone is accessible from within a two-block address space. Within this document the nomenclature OTP[bb] indicates a byte within the OTP zone, while OTP[aa:bb] indicates a range of bytes.

Within this document, the terms “slot” and “block” are used interchangeably to mean a single, 256-bit (32-byte) area of a particular memory zone. Industry SHA-256 documentation uses the term “block” to indicate a 512-bit section of the message input. In addition, the I/O section of this document uses the term “block” to indicate a variable-length aggregate element transferred between the system and the device.

In this specification, the nomenclature *mode:b* indicates bit b of the parameter mode.

On shipment from Atmel, the EEPROM contains factory test data that can be used for fixed-value board testing. This data must be overwritten with the desired contents prior to locking the configuration and/or data sections of the device. See the [Atmel website](#) for the document containing the specific shipment values.

#### 2.1.1 Data Zone

The Data zone is 512-bytes (4Kb), is part of the EEPROM array, and can be used for secure storage purposes. Prior to locking the configuration section by using lock(Config), the Data zone is inaccessible and can be neither read nor written. After configuration locking, the entire Data zone can be written using the Write command. If desired, the data to be written can be encrypted.

In [Table 2-1](#), “Byte Address” is the byte address within the Data zone for the first byte in the respective slot. Because all Reads and Writes with the ATSHA204A are performed on a word (4-byte or 32-byte) basis, and the word address in the table below should be used for the address parameter passed to the Read and Write commands.

**Table 2-1. Data Zone Slots**

Slot	Byte Address (Hex)	Word Address (Hex)
0	0x0000	0x0000
1	0x0020	0x0008
2	0x0040	0x0010
3	0x0060	0x0018
4	0x0080	0x0020
5	0x00A0	0x0028
6	0x00C0	0x0030
7	0x00E0	0x0038

Slot	Byte Address (Hex)	Word Address (Hex)
8	0x0100	0x0040
9	0x0120	0x0048
10	0x0140	0x0050
11	0x0160	0x0058
12	0x0180	0x0060
13	0x01A0	0x0068
14	0x01C0	0x0070
15	0x01E0	0x0078

## 2.1.2 Configuration Zone

The 88-bytes (704-bits) in the Configuration zone contain manufacturing identification data, general device, and system configuration, and access restriction control values for the slots within the Data zone. The values of these bytes can always be obtained using the Read command. The bytes of this zone are arranged as shown in [Table 2-2](#).

**Table 2-2. Configuration Zone**

Word	Byte 0	Byte 1	Byte 2	Byte 3	Default	Write Access	Read Access
0x00	Serial Number[0:3]				01 23 xx xx	Never	Always
0x01	Revision Number				xx xx xx xx	Never	Always
0x02	Serial Number[4:7]				xx xx xx xx	Never	Always
0x03	SN[8]	Reserved	I2C Enable	Reserved	EE 55 xx 00	Never	Always
0x04	I2C Address	CheckMacConfig	OTP Mode	Selector Mode	C8 00 55 00	If Config Is unlocked	Always
0x05	Slot Configuration 0		Slot Configuration 1		8F 80 80 A1	If Config Is unlocked	Always
0x06	Slot Configuration 2		Slot Configuration 3		82 E0 A3 60	If Config Is unlocked	Always
0x07	Slot Configuration 4		Slot Configuration 5		94 40 A0 85	If Config Is unlocked	Always
0x08	Slot Configuration 6		Slot Configuration 7		86 40 87 07	If Config Is unlocked	Always
0x09	Slot Configuration 8		Slot Configuration 9		0F 00 89 F2	If Config Is unlocked	Always
0x0A	Slot Configuration 10		Slot Configuration 11		8A 7A 0B 8B	If Config Is unlocked	Always
0x0B	Slot Configuration 12		Slot Configuration 13		0C 4C DD 4D	If Config Is unlocked	Always
0x0C	Slot Configuration 14		Slot Configuration 15		C2 42 AF 8F	If Config Is unlocked	Always
0x0D	Use Flag 0	Update Count 0	Use Flag 1	Update Count 1	FF 00 FF 00	If Config Is unlocked	Always
0x0E	Use Flag 2	Update Count 2	Use Flag 3	Update Count 3	FF 00 FF 00	If Config Is unlocked	Always
0x0F	Use Flag 4	Update Count 4	Use Flag 5	Update Count 5	FF 00 FF 00	If Config Is unlocked	Always
0x10	Use Flag 6	Update Count 6	Use Flag 7	Update Count 7	FF 00 FF 00	If Config Is unlocked	Always
0x11	Last Key Use 0	Last Key Use 1	Last Key Use 2	Last Key Use 3	FF FF FF FF	If Config Is unlocked	Always
0x12	Last Key Use 4	Last Key Use 5	Last Key Use 6	Last Key Use 7	FF FF FF FF	If Config Is unlocked	Always
0x13	Last Key Use 8	Last Key Use 9	Last Key Use 10	Last Key Use 11	FF FF FF FF	If Config Is unlocked	Always
0x14	Last Key Use 12	Last Key Use 13	Last Key Use 14	Last Key Use 15	FF FF FF FF	If Config Is unlocked	Always
0x15	User Extra	Selector	Lock Data	Lock Config	00 00 55 55	Via Update Extra Command Only	Always

### 2.1.2.1 I2C Enable

- Bit 0: If zero, it is a Single-Wire Interface.  
If one, it is an I<sup>2</sup>C interface.
- Bit 1–7: Ignored and set by Atmel.

### 2.1.2.2 I<sup>2</sup>C Address

#### I<sup>2</sup>C

- Bit 0: Ignored.
- Bits 1 – 7: I<sup>2</sup>C device address

#### Single-Wire

- Bits 0 – 2: Ignored.
- Bit 3: TTL Enable  
If zero, then the input level uses a fixed reference.  
If one, then the input level uses the V<sub>CC</sub> reference.
- Bits 4 – 7: Ignored.

### 2.1.2.3 CheckMacConfig

This byte applies only to the `CheckMac`, `Read`, and `Write` commands:

- **Read and Write**  
Bit 0 controls Slots 0 and 1, bit 1 controls Slots 2 and 3, and so on. Any encrypted Read/Write command will fail if the value in `TempKey.SourceFlag` does not match the corresponding bit in this byte. This byte is ignored for clear text reads and writes.
- **CheckMac**  
Bit 0 controls slot 1, bit 1 controls Slot 3 and so on. The copy function will only be enabled if the `CheckMacSource` value corresponding to the target slot matches the value of Mode bit 2 of the `CheckMac` command. The command will fail if Mode bit 2 does not match `TempKey.SourceFlag`, so this is equivalent to requiring the corresponding bit in this byte to match `TempKey.SourceFlag`.

### 2.1.2.4 OTP Mode

0xAA (Read-only mode) = When OTP zone is locked, writes are disabled and reads of all words are permitted.

0x55 (Consumption mode) = Writes to the OTP zone when the OTP zone is locked will causes the bits to transition only from a one to a zero. Reads of all words are permitted.

0x00 (Legacy mode) = When OTP zone is locked, writes are disabled, reads of Words 0 and 1, and 32-byte reads are disabled.

All other modes are reserved.

### 2.1.2.5 Selector Mode

If zero, then the Selector will be updated with `UpdateExtra`.

All other values will only allow the Selector to be updated if it's value is zero.

### 2.1.2.6 Slot Config

See [Table 2-3, SlotConfig Bits \(Per Slot\)](#).

### 2.1.2.7 Use Flag

For uses with “single-use slots”. The quantity of “1” bits represents the number of times that slots 0 thru 7 may be used before being disabled.

### 2.1.2.8 Update Count

Indicates how many times slots 0 thru 7 have been updated with DeriveKey.

### 2.1.2.9 Last Key Use

Used to control limited use for Slot 15. Each “1” bit represents a remaining use for Slot 15. Applies only if SlotConfig[.5] Single Use is set.

### 2.1.2.10 UserExtra

For general system use, can be modified via the UpdateExtra command.

### 2.1.2.11 Selector

Selects which device will remain in active mode after the execution of the Pause command.

### 2.1.2.12 Lock Data

Controls the Data and OTP zones are unlocked and can be freely written but not read.

0x55 = The Data and OTP zones are unlocked and has write access.

0x00 = The Data and OTP zones are locked. Slots in the Data zone can only be modified based on the corresponding WriteConfig fields. The OTP zone can only be modified based on the OTP mode.

### 2.1.2.13 Lock Config

Configuration zone access.

0x55 = The Configuration zone has write access (unlocked).

0x00 = The Configuration zone does not have write access (locked).

### 2.1.2.14 SlotConfig (Bytes 20 – 51)

The 16 SlotConfig elements configure the access protections for each of the 16 slots within the ATSHA204A. Each configuration element consists of 16 bits, which control the usage and access for that particular slot or key. The SlotConfig field is interpreted according to [Table 2-3](#) when the Data zone is locked. When the Data zone is unlocked, these restrictions do not apply, and all slots may be freely written and none may be read.

**Table 2-3. SlotConfig Bits (Per Slot)**

Bit	Name	Description
0 – 3	ReadKey	Slot of the key to be used for encrypted reads. If 0x0, then this slot can be used as the source slot for the CheckMac Copy Command.
4	CheckOnly	0 = This slot can be used for all crypto commands. 1 = This slot can only be used for CheckMac and GenDig followed by CheckMac Commands.
5	SingleUse	0 = No limit on the number of time the key can be used. 1 = Limit on the number of time the key can be used based on the UseFlag (or LastKeyUse) for the slot.
6	EncryptRead	0 = Clear reads are permitted. 1 = Requires the slot to be Secret and encrypted read to access.
7	IsSecret	0 = The slot is not secret and allows clear read, clear write, no MAC check, and no Derivekey Command. 1 = The slot is secret. Reads and writes if allowed, must be encrypted.
8 – 11	WriteKey	Slot of the key to be used to validate encrypted writes.
12 – 15	Write Config	See detailed function definition for use.

**Table 2-4. Write Configuration Bits — Derivekey Command**

Bit 15	Bit 14	Bit 13	Bit 12	Source Key <sup>(1)</sup>	Description
0	X	1	0	Target	DeriveKey command can be run without authorizing MAC (Roll).
1	X	1	0	Target	Authorizing MAC required for DeriveKey command (Roll).
0	X	1	1	Parent	DeriveKey command can be run without authorizing MAC (Create).
1	X	1	1	Parent	Authorizing MAC required for DeriveKey command (Create).
X	X	0	X	—	Slots with this value in the WriteConfig field may not be used as the target of the DeriveKey command.

Note: 1. The source key for the computation performed by the DeriveKey command can either be the key directly specified in Param2 (the “Target”) or the key at slotConfig[Param2].WriteKey (the “Parent”). See [Section 13.3, “Key Values”](#) for more details.

**Table 2-5. Write Configuration Bits — Write Command**

Bit 15	Bit 14	Bit 13	Mode Name	Description
0	0	0	Always	Clear text writes are always permitted on this slot. Slots set to “always” should never be used as key storage. Either 4 or 32 bytes may be written to this slot.
X	0	1	Never	Writes are never permitted on this slot using the Write command Slots set to “never” can still be used as key storage.
1	0	X	Never	Writes are never permitted on this slot using the Write command Slots set to “never” can still be used as key storage.
X	1	X	Encrypt	Writes to this slot require a properly computed MAC, and the input data must be encrypted by the system with WriteKey using the encryption algorithm documented in the Write command description ( <a href="#">Section 8.5.17, “UpdateExtra Command”</a> ). 4-byte writes to this slot are prohibited.

The 4-bit WriteConfig field is interpreted by the Write command as shown in [Table 2-5](#), where X means *don't care*.

Note: The tables overlap. For example, a code of 0110 indicates that a slot can be written in encrypted form by using the Write command, and it can also be the target of an unauthorized DeriveKey command with the target as the source.

The IsSecret bit controls internal circuitry necessary for proper security for slots in which reads and/or writes must be encrypted or are prohibited altogether. It must also be set for all slots that are to be used as keys, including those created or modified with DeriveKey. Specifically, to enable proper device operation, this bit must be set unless WriteConfig is “Always”. 4-byte accesses are prohibited to/from slots in which this bit is set.

Slots used to store key values should always have IsSecret set to one and EncryptRead set to zero (reads prohibited) for maximum security. For fixed key values, WriteConfig should be set to “Never”. When configured in this way, there is no way to read or write the key after the Data zone is locked. It may only be used for crypto operations.

Some security policies require secrets to be updated from time to time. The ATSHA204A supports this capability in the following way:

WriteConfig for the particular slot should be set to “Encrypt”, and SlotConfig.WriteKey should point back to the same slot by setting WriteKey to the slot ID. A standard Write command can be then used to write a new value to this slot provided that the authentication MAC is computed using the old (current) key value.

### 2.1.2.15 Special Memory Values in the Configuration Zone (Bytes 0 – 12)

Various fixed information is included in the ATSHA204A that can never be written under any circumstances and can always be read, regardless of the state of the lock bits.

- **SerialNum**

Nine bytes (SN[0:8]) which together form a unique value that is never repeated for any device in the CryptoAuthentication family. The serial number is divided into two groups:

1. **SN[0:1] and SN[8]**

The values of these bits are fixed at manufacturing time in most versions of the ATSHA204A. Their default value is (0x01 0x23 0xEE). These 24 bits are always included in the SHA-256 computations made by the ATSHA204A.

2. **SN[2:7]**

The values of these bits are programmed by Atmel during the manufacturing process and are different for every die. These 6-bytes (48-bits) are optionally included in some SHA-256 computations made by the ATSHA204A.

- **RevNum**

4-bytes of information that are used by Atmel to provide manufacturing revision information. These bytes can be freely read as RevNum[0:3], but should never be used by system software, because they may vary from time to time.

### 2.1.3 One Time Programmable (OTP) Zone

The OTP zone of 64 bytes (512 bits) is part of the EEPROM array, and can be used for read-only storage.

Prior to locking the configuration section (using lockConfig), the OTP zone is inaccessible and can be neither read nor written. After configuration locking, but prior to locking of the OTP zone (using lockData), the entire OTP zone can be written using the Write command. If desired, the data to be written can be encrypted. When unlocked the OTP zone cannot be read.

Once the OTP zone is locked, the OTPmode byte in the Configuration zone controls the permissions of this zone, as follows:

- **Read-only Mode**

In this mode, the data cannot be modified, and would be used to store fixed model numbers, calibration information, manufacturing history, and/or other data that should never change. The Write command will always return an error and leave the memory unmodified.

All 64-bytes within the OTP section are always available for reading using either 4-byte or 32-byte reads.

- **Consumption Mode**

In this mode, the bits function as one-way fuses, and can be used to track consumption or usage of the item to which the ATSHA204A is attached. For examples, in a battery, they might be used to track charging cycles or use time; in a printer ink cartridge, they might track the quantity of material consumed; in a medical device, they might track the number of permitted uses for a limited use item.

In this mode, the Write command can only cause bits to transition from a one to a zero. Logically, this means the data value in the input parameter list will be AND'ed with the current value in the word(s) and the result written back to memory.

**Example:** Writing a value of 0xFF results in no change to the byte and writing a value of 0x00 causes the byte in memory to go to zero, regardless of the previous value. Once a bit has transitioned to a zero, it can never transition back to a one.

- **Legacy Mode**

In the Legacy mode, the operation of the OTP zone is consistent with the fuse array on the Atmel ATSA102S. Reads of words zero and one are always prohibited, while reads of the remaining 14 words are always permitted. Only 4-byte (32-bit) reads are permitted, and any attempt to execute a 32-byte (256-bit) read will result in an error return code. All Write operations to the OTP zone are prohibited. See [Section 9., “Compatibility”](#) for more of the Atmel ATSA102S compatibility details.

All OTP zone bits have a value of one on shipment from the Atmel factory.

**Table 2-6. OTP Zone**

Word (HEX)	Address (HEX)	Default
0x00	0x00	0xFFFFFFFF
0x01	0x04	0xFFFFFFFF
0x02	0x08	0xFFFFFFFF
0x03	0x0C	0xFFFFFFFF
0x04	0x10	0xFFFFFFFF
0x05	0x14	0xFFFFFFFF
0x06	0x18	0xFFFFFFFF
0x07	0x1C	0xFFFFFFFF
0x08	0x20	0xFFFFFFFF
0x09	0x24	0xFFFFFFFF
0x0A	0x28	0xFFFFFFFF
0x0B	0x2C	0xFFFFFFFF
0x0C	0x30	0xFFFFFFFF
0x0D	0x34	0xFFFFFFFF
0x0E	0x38	0xFFFFFFFF
0x0F	0x3C	0xFFFFFFFF

## 2.1.4 Device Locking

There are two separate lock bytes for the device:

- Lock the Configuration zone (controlled by LockConfig, byte 87).
- Lock both the Data and OTP zones (controlled by LockData, byte 86).

These locks are stored within separate bytes in the Configuration zone, and can be modified only through the `Lock` command. After a memory zone is locked, there is no way to unlock it.

The device should be personalized at the system manufacturer with the desired configuration information, and the Configuration zone should be locked. When this lock is complete, all necessary writes of public and secret information into the EEPROM slots should be performed using encrypted writes if appropriate. Upon completion of writes to the data and OTP zones, the Data and OTP zones should be locked.

It is vital that the Data and OTP zones are locked prior to release of the system containing the device into the field. Failure to lock these zones may permit modification of any secret keys and may lead to other security problems.

Any attempt to read or write the Data or OTP sections prior to locking the configuration section causes the device to return an error.

Contact Atmel for optional secure personalization services.

### 2.1.4.1 Configuration Zone Locking

Certain bytes within the Configuration zone cannot be modified, regardless of the state of LockConfig. Access to the remainder of the bytes within the zone is controlled using the LockConfig byte in the Configuration zone, as shown in [Table 2-7](#). Throughout this document, if LockConfig is `0x55`, then the Configuration zone is said to be unlocked; otherwise it is locked.

**Table 2-7. Configuration Zone Locking**

	Read Access	Write Access
LockConfig == 0x55 (unlocked)	Read	Write
LockConfig != 0x55 (locked)	Read	<never>

### 2.1.4.2 Data and OTP Zone Locking

Throughout this document, if LockData is `0x55`, then both the Data and OTP zones are said to be unlocked; otherwise they are locked.

Note: There is neither read nor write access to the Data and OTP zones prior to locking of the Configuration zone.

**Table 2-8. Data and OTP Zone Access Restrictions**

	Read Access	Write Access
LockData == 0x55 (unlocked)	<never>	Write
LockData != 0x55 (locked)	Read <sup>(1)</sup>	Write <sup>(1)</sup>

Note: 1. Based on Slot Configuration for a given slot.

### 2.1.4.3 OTP Zone Locking

Reads and writes of the OTP zone depend upon the state of the LockConfig, LockData, and OTP mode bytes in the Configuration zone.



## 2.2 Static RAM (SRAM)

The device includes an SRAM Array that is used to store the input command or output result, intermediate computation values, and/or an ephemeral key. The entire contents of this memory are always invalidated whenever the device goes into sleep mode or the power is removed. The ephemeral key is named TempKey, and can be used as an input to the MAC, HMAC, CheckMac, GenDig, and DeriveKey commands. It is also used as the Data protection (Encryption or Decryption) key by the Read and Write commands. See the below, [Section 2.2.1, “TempKey”](#).

### 2.2.1 TempKey

TempKey is a storage register in the SRAM array that can be used to store an ephemeral result value from the Nonce, GenDig, CheckMac, or SHA commands. The contents of this register can never be read from the device (although the device itself can read and use the contents internally).

This register contains the elements shown in [Table 2-9](#).

**Table 2-9. TempKey Storage Register**

Name	Bit Length	Description
TempKey	256 (32-bytes)	Nonce (from Nonce command) or Digest (from GenDig command).
SlotID	4	If TempKey was generated by GenDig (see the GenData and CheckFlag bits), these bits indicate which key was used in its computation. The four bits represent one of the slots of the Data zone.
SourceFlag	1	The source of the randomness in TempKey: 0 = Internally generated random number ( <i>Rand</i> ). 1 = Input seed only, no internal random generation ( <i>Input</i> ).
GenData	1	0 = TempKey.SlotID is not meaningful, and is ignored. 1 = The contents of TempKey were generated by GenDig using one of the slots in the Data zone (and TempKey.SlotID will be meaningful).
CheckFlag	1	If one, the contents of TempKey were generated by the GenDig command and at least one of the keys used in that generation is restricted to the CheckMac command (SlotConfig.CheckOnly is one); otherwise, this bit will be zero.
Valid	1	0 = The information in TempKey is invalid. 1 = The information in TempKey is valid.

In this specification, the name “TempKey” refers to the contents of the 32-byte (256-bit) Data register. The remaining bit fields are referred to as TempKey.SourceFlag, TempKey.GenData, and so on.

The TempKey.Valid bit is cleared to zero under any of the following circumstances:

- Power-up, sleep, brown-out, watchdog expiration, or tamper detection. The contents of TempKey are however retained when the device enters idle mode.
- After the execution of any command other than Nonce or GenDig, regardless of whether or not the command execution succeeds. It may be cleared by the CheckMac command unless a successful copy takes place. It is *not* cleared if there is a communications problem, as evidenced by a Cyclic Redundancy Check (CRC) error.
- An error during the parsing or execution of a GenDig and/or Nonce command.
- Execution of GenDig replaces any previous output of the Nonce command with the output of the GenDig command. Execution of the Nonce command likewise replaces any previous output of the GenDig command.

## 3. Security Features

### 3.1 Physical Security

The ATSHA204A incorporates a number of physical security features designed to protect the EEPROM contents from unauthorized exposure. The security measures include:

- An Active Shield Over the Part
- Internal Memory Encryption
- Secure Test Modes
- Glitch Protection
- Voltage Tamper Detection

Pre-programmed transport keys stored on the ATSHA204A are encrypted in such a way as to make retrieval of their values using outside analysis very difficult.

Both the logic clock and logic supply voltage are internally generated, preventing any direct attack on these two signals using the pins of the device.

### 3.2 Random Number Generator (RNG)

The ATSHA204A includes a high-quality RNG that returns a 32-byte random number to the system. The device combines this generated number with a separate input number to form a nonce that is stored within the device in TempKey and may be used by subsequent commands.

The system may use this RNG for any purpose. One common purpose would be as the input challenge to the MAC command on a separate CryptoAuthentication device. The device provides a special random command for such purposes, which does not affect the internally stored nonce.

To simplify system testing, prior to locking the Configuration zone the RNG always returns the following value:

ff ff 00 00 ff ff 00 00 ... where ff is the first byte read from the device and is used for the SHA message.

To prevent replay attacks on encrypted data that is passed to or from the ATSHA204A, the device requires that a new, internally generated nonce be included as part of the encryption sequence used to protect the data being read or written. To implement this requirement, the data protection key generated by GenDig and used by the Read or Write command must use the internal RNG during the creation of the nonce.

Random numbers are generated from a combination of the output of a hardware RNG and an internal seed value, which is not externally accessible. The internal seed is stored in the EEPROM, and is normally updated once after every power-up or sleep/wake cycle. After the update, this seed value is retained in SRAM registers within the device that are invalidated if the device enters sleep mode or the power is removed.

## 4. General I/O Information

Communication with the ATSHA204A is achieved through one of two different protocols (I<sup>2</sup>C or Single-Wire) and is selected based on the device ordered:

- **Single-Wire Interface**

This mode uses a single GPIO connection on the system microprocessor connected to the SDA pin on the device. It permits the fewest number of connector pins to any removable/replaceable entity. The bit rate is up to 26Kb/s and is compatible with standard UART signaling.

- **I<sup>2</sup>C Interface**

This mode is compatible with the Atmel AT24C16 Serial EEPROM interface. Two pins are required, Serial Data (SDA) and Serial Clock (SCL). The I<sup>2</sup>C interface supports a bit rate of up to 1Mb/s.

The lowest levels of the I/O protocols are described in [Section 5.](#), “Single-Wire Interface” and [Section 6.](#), “I<sup>2</sup>C Interface”. On top of the I/O protocol level, both interfaces transmit exactly the same bytes to and from the device to implement the cryptographic commands and error codes documented in [Section 8.](#), “Security Commands”.

**Note:** The device implements a failsafe internal watchdog timer that forces it into a very low-power mode after a certain time interval, regardless of any current activity. System programming must take this into consideration. See [Section 8.4.](#), “Watchdog Failsafe” for details.

### 4.1 Byte and Bit Ordering

CryptoAuthentication uses a common ordering scheme for bytes and also for the way in which numbers and arrays are represented in this datasheet:

- All multi-byte aggregate elements are treated as arrays of bytes and are processed in the order received or transmitted with index #0 first.
- 2-byte (16-bit) integers, typically Param2 appear on the bus least-significant byte first.

The bit order is different depending on the I/O channel used:

- On the Single-Wire Interface, data is transferred to/from the ATSHA204A least-significant bit first on the bus.
- On the I<sup>2</sup>C Interface, data is transferred to/from the ATSHA204A most-significant bit first on the bus.

#### 4.1.1 Output Example

The following bytes will be returned in this order on the bus by a 32-byte read of the configuration section with an input address of 0x0000:

SN[0], SN[1], SN[2], SN[3], RevNum[0], RevNum[1], RevNum[2], RevNum[3], SN[4], SN[5], SN[6], SN[7], SN[8], reserved, I2C Enable, reserved, I2C\_Address, OTPmode, SelectorMode, SlotConfig[0].Read, SlotConfig[0].Write, SlotConfig[1].Read, SlotConfig[1].Write, SlotConfig[2].Read, SlotConfig[2].Write, SlotConfig[3].Read, SlotConfig[3].Write, SlotConfig[4].Read, SlotConfig[4].Write, SlotConfig[5].Read, SlotConfig[5].Write

#### 4.1.2 MAC Message Example

The following bytes will be passed to the SHA engine for a MAC command using a mode value of 0x71 and a SlotID of slot x. In the example below, K[x] indicates the SlotID of slot x in the Data zone, with K[0] being the first byte on the bus for a read from or write to that slot. OTP[0] indicates the first byte on the bus for a read of the OTP zone at address zero, and so on.

K[0], K[1], K[2], K[3] ... K[31], TempKey[0], TempKey[1], TempKey[2], TempKey[3] ... TempKey[31], Opcode (=0x08), Mode (=0x71), Param2(LSB = x), Param2(MSB = 0), OTP[0], OTP[1], OTP[2], OTP[3], OTP[4], OTP[5], OTP[6], OTP[7], OTP[8], OTP[9], OTP[10], SN[8], SN[4], SN[5], SN[6], SN[7], SN[0], SN[1], SN[2], SN[3].

For more details regarding MAC messages, see [Section 8.5.11.](#), “MAC Command”.

## 5. Single-Wire Interface

In the Single-Wire Interface mode, communications to and from the ATSHA204A take place over the SDA pin, a single, asynchronously timed wire, and the SCL pin is ignored.

Note: The sleep current specification values are guaranteed only if the SCL pin is held low or left unconnected.

The overall communications structure is a hierarchy: The figure below shows how to uses the Single-Wire Interface with a standard RS-232 port. The port should be set to 7-bit addressing and 230 baud.

### Wake Tokens

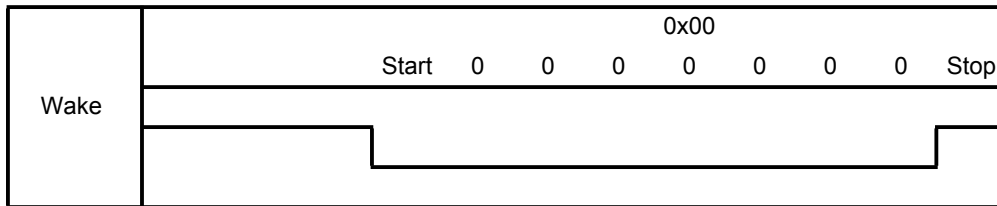

**I/O Tokens** I/O tokens implement a single data bit transmitted on the bus, or the wake-up event.

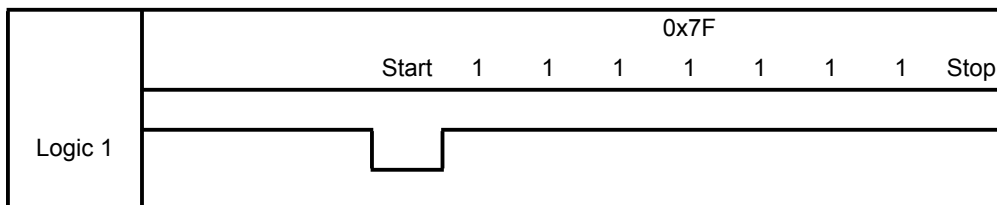
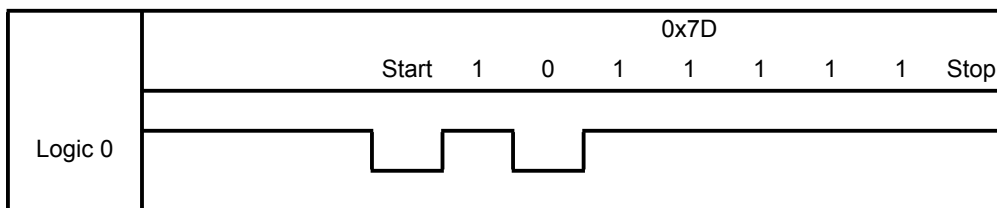

**I/O Flags** Flags consist of eight tokens (bits) that convey the direction and meaning of the next group of bits (if any) that may be transmitted. Flags are always transmitted LSB first.

**Blocks** Blocks of data follow the command and transmit flags. They incorporate both a byte count and a checksum to ensure proper data transmission.

**Packets** Packets of bytes form the core of the block (minus the byte count and CRC). They are either the input or output parameters of a CryptoAuthentication command or status information from the ATSHA204A.

## 5.1 I/O Tokens

There are a number of I/O tokens that may be transmitted over the Single-Wire Interface:

**Input:** (to the ATSHA204A)

- Wake** Wake the device up from either sleep or idle states.
- Zero** Send a single bit from the system to the device with a value of zero.
- One** Send a single bit from the system to the device with a value of one.

**Output:** (from the ATSHA204A)

- ZeroOut** Send a single bit from the device to the system with a value of zero.
- OneOut** Send a single bit from the device to the system with a value of one.

The waveforms are the same in either direction. There are some differences in timing; however, based on the expectation that the Host has a very accurate and consistent clock, while the ATSHA204A has significant part-to-part variability in its internal clock generator, due to normal manufacturing and environmental fluctuations.

The bit timing is designed to permit a standard UART running at 230.4Kbaud to transmit and receive the tokens efficiently. Each byte transmitted or received by the UART corresponds to a single bit received or transmitted by the device. The UART needs to be configured with 7-bits of data having 0x7F corresponding to a Logic 1 and 0x7D corresponding to a Logic 0.

The Wake token is special in that it requires an extra long low pulse of 8 $\mu$ s on the SDA pin (see [Table 7-3](#)), which cannot be confused with the shorter low pulses that occur during a Data token (Zero, One, ZeroOut, or OneOut). Devices that are in either the idle or sleep state ignore all data tokens until they receive a legal Wake token. Do not send a Wake token to devices that are awake, as they will lose synchronization because the waveform can be resolved to neither a legal one nor zero. See [Section 5.3.2, “Synchronization Procedures”](#) for the procedure to regain synchronization.

## 5.2 I/O Flags

The system is always the bus master; so before any I/O transaction, the system must send an 8-bit flag to the device to indicate the I/O operation to be subsequently performed, as shown in [Table 5-1](#).

**Table 5-1. I/O Flags**

Name	Value (Single-Wire)	Description
Sleep (low-power)	0xCC	The ATSHA204A goes into the low-power sleep mode and ignores all subsequent I/O transitions until the next Wake flag. The entire volatile state of the device is reset.
Idle	0xBB	The ATSHA204A goes into the idle state and ignores all subsequent I/O transitions until the next Wake flag. The contents of TempKey and RNG seed registers are retained.
Command	0x77	Write subsequent bytes to sequential addresses in the input command buffer.
Reserved	All Other Values	These flags should not be sent to the device.
Transmit	0x88	Communicates to the device to wait for a bus turnaround time and then start transmitting its response to the previously transmitted command block. When valid data is in the output buffer, the transmit flag may be repeatedly issued to the device to resend the buffer to the system.
Wake	See Interface	Wake the device from low-power mode and reset the watchdog counter.

### 5.2.1 Transmit Flag

The transmit flag is used to turn the bus around so that the ATSHA204A can send data back to the system. The bytes that the device returns to the system depend upon the current state of the device, and may include either status, error code, or command results.

When the device is busy executing a command, it ignores the SDA pin and any flags that are sent by the system. See [Section 8.5.2, “Command Opcodes, Short Descriptions, and Execution Times”](#) for execution delays in the device for each command type. The system must observe these delays before trying to communicate with the device after sending a command.

## 5.3 Synchronization

Because the communications protocol is half-duplex, there is the possibility that the system and the ATSHA204A will fall out of synchronization with each other. In order to speed recovery, the device implements a timeout that forces it to sleep under certain circumstances.

### 5.3.1 I/O Timeout

After a leading transition for any data token has been received, the ATSHA204A will expect the remaining bits of the token to be properly received by the device within the  $t_{\text{TIMEOUT}}$  interval. Failure to send enough bits or the transmission of an illegal token (a low pulse exceeding  $t_{\text{ZLO}}$ ) will cause the device to enter the sleep state after the  $t_{\text{TIMEOUT}}$  interval.

The same timeout applies during the transmission of the command block. After the transmission of a legal command flag, the I/O timeout circuitry is enabled until the last expected data bit is received.

Note: The timeout counter is reset after every legal token, and the total time to transmit the command may exceed the  $t_{\text{TIMEOUT}}$  interval while the time between bits may not.

The I/O timeout circuitry is disabled when the device is busy executing a command.

### 5.3.2 Synchronization Procedures

If the device is not busy when the system sends a transmit flag, the device should respond within  $t_{\text{TURNAROUND}}$ . If  $t_{\text{EXEC}}$  time has not already passed, the device may be busy, and the system should poll or wait until the maximum  $t_{\text{EXEC}}$  time has elapsed. If the device still does not respond to a second transmit flag within  $t_{\text{TURNAROUND}}$ , it may be out of synchronization. At this point, the system may take the following steps to reestablish communication:

1. Wait  $t_{\text{TIMEOUT}}$ .
2. Send the transmit flag.
3. If the device responds within  $t_{\text{TURNAROUND}}$ , then the system may proceed with more commands.
4. Send a Wake token.
5. Wait  $t_{\text{WHI}}$ .
6. Send the transmit flag.
7. The device should respond with a 0x11 status within  $t_{\text{TURNAROUND}}$ , at which time system may proceed with commands.

Any command results in the I/O buffer may be lost when the system and device lose synchronization.

## 5.4 Sharing the Interface

Multiple CryptoAuthentication devices may share the same interface, as follows:

1. System issues a Wake token (Section 8.4, “Watchdog Failsafe”) to wake-up all devices.
2. The system issues the `Pause` command to put all but one of the devices into idle mode. Only the remaining device then sees any commands that the system sends. When the system has completed talking to the one active device, it sends an idle flag, which the idle devices ignore, but puts the single remaining active device into the idle mode. See Section 8.5.13, “Pause Command” for more details.

Steps 1 and 2 are repeated for each device on the wire. If the system has completed communications with the final device, it should wake all the devices up and then put all the devices to sleep to reduce total power consumption.

The device uses the selector byte within the Configuration zone to determine which device stays awake. Only that device with a selector value that matches the input parameter of the `Pause` command stays awake. In order to facilitate late configuration of systems that use the multi-device sharing mode, the following three update capabilities for the selector byte are supported:

1. **Unlimited Updates**  
At any time, the `UpdateExtra` command can be executed to write the value in the selector field of the Configuration zone. To enable this mode, set the `SelectorMode` byte in the Configuration zone to zero.
2. **One-time Field Update**  
If the `SelectorMode` byte is set to a non-zero value and the selector byte is set to a zero value prior to locking the Configuration zone. Then, at any time after the Configuration zone is locked the `UpdateExtra` command can be used one time to set `Selector` to a non-zero value. The `UpdateExtra` command is not affected by the `LockData` byte.
3. **Fixed Selector Value**  
The selector byte can never be modified after the Configuration zone is locked if both `SelectorMode` and `Selector` are set to non-zero values. The `UpdateExtra` command will always return an error code.

## 5.5 Transaction Example

Figure 5-1. Wake (Single-Wire)

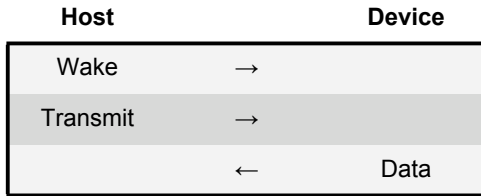

Figure 5-2. Example (Single-Wire)

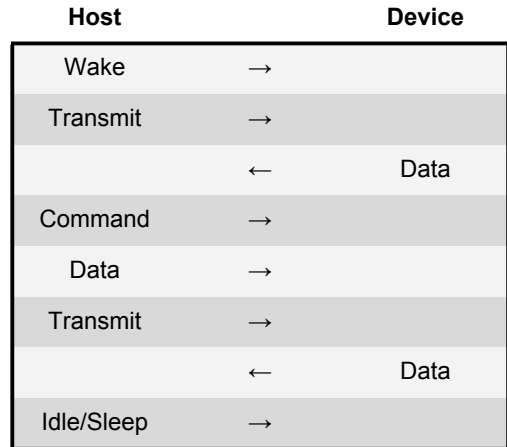
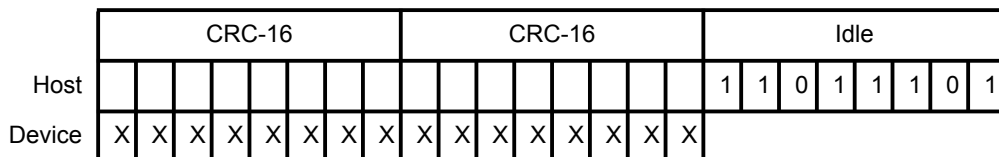
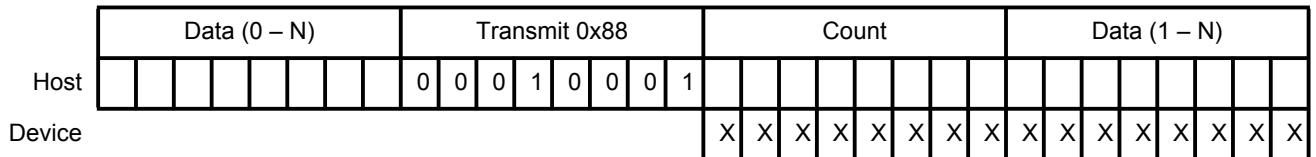
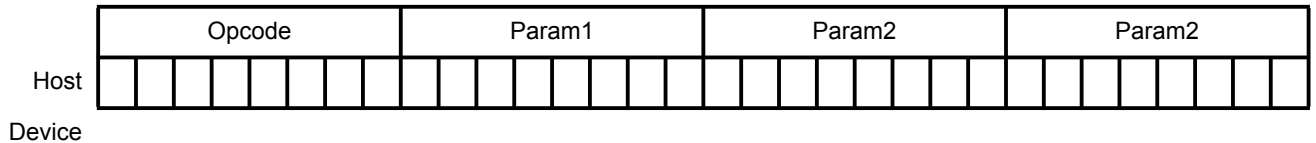
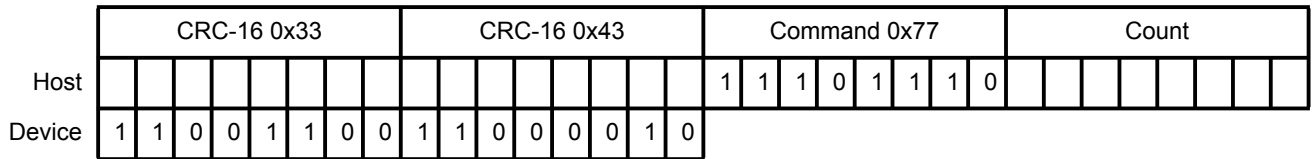
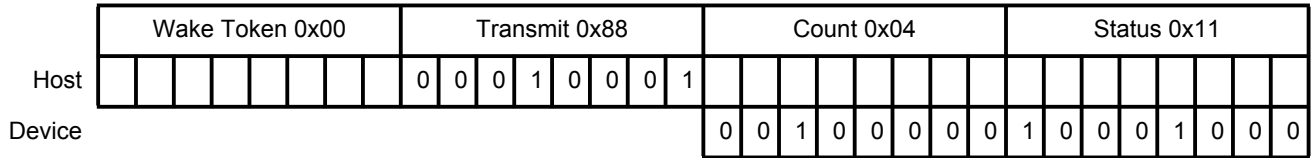

Figure 5-3. Example (Single-Wire)





## 5.6 Wiring Configuration for Single-Wire Interface

The Single-Wire Interface allows the connection of the ATSHA204A to a Host using only a single SDA pin to transfer data in both directions. This interface does not use the SCL pin. The ATSHA204A does not require a bypass capacitor when wired in this configuration if the impedance of the power and ground signals back to the power supply is low. Atmel recommends a bypass capacitor always be used for the best reliability.

To prevent forward biasing the internal diode and drawing current across power planes in the system, the resistor pull-up on the SDA pin should either be connected to the same supply that is connected to the  $V_{CC}$  pin or to a lower voltage rail.

If the signal levels for SDA are different from the  $V_{CC}$  voltage, consult the parametric specifications section of this document to ensure that the signal levels are such that excessive leakage current will be minimized when in sleep modes. This situation might occur if the ATSHA204A device is physically distant from the bus master device, or the supply voltage for the bus master is different from the supply voltage for the ATSHA204A.

Figure 5-4. 3-wire Configuration for Single-Wire Interface

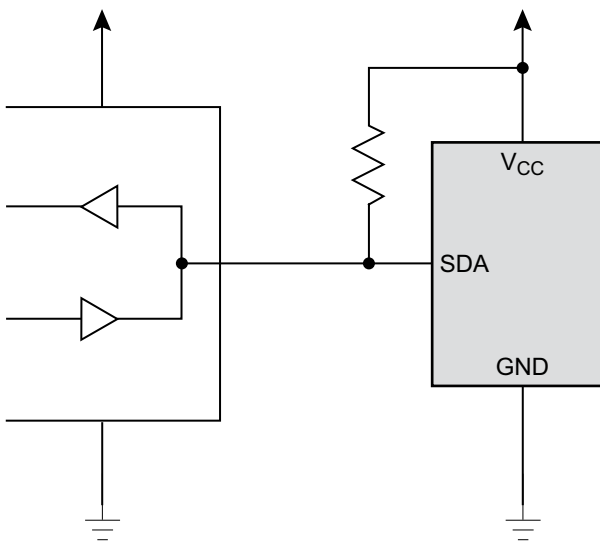

### 5.6.1 2-lead Configuration

There is a Schottky diode internal to the device that is connected between the SDA and  $V_{CC}$  pins which permits the ATSHA204A to steal power from the SDA pin and store it on the bypass capacitor. In this case, the  $V_{CC}$  pin does not need to be connected to the Host's power supply. This configuration permits the board containing the ATSHA204A and a bypass capacitor to be connected to the Host's microprocessor using just two leads (i.e. SDA and GND).

If the system supply voltage level is at least 3V, the pull-up resistor should be no greater than 1K, and the capacitor no less than 0.03 $\mu$ F. The device will operate properly keeping  $V_{CC}$  at or above the specification level of 2V. Contact Atmel for other configuration information.

In a 2-lead configuration, the SDA pin must be driven high to  $V_{CC}$  using an active driver capable of supplying  $I_{CC}$  for the entire duration of any command execution, and a totem pole driver should be used to send data to the device. The resistor should be driving the SDA line *only* during transmission of data from the ATSHA204A to the system

Figure 5-5. 2-lead Configuration for Single-Wire Interface

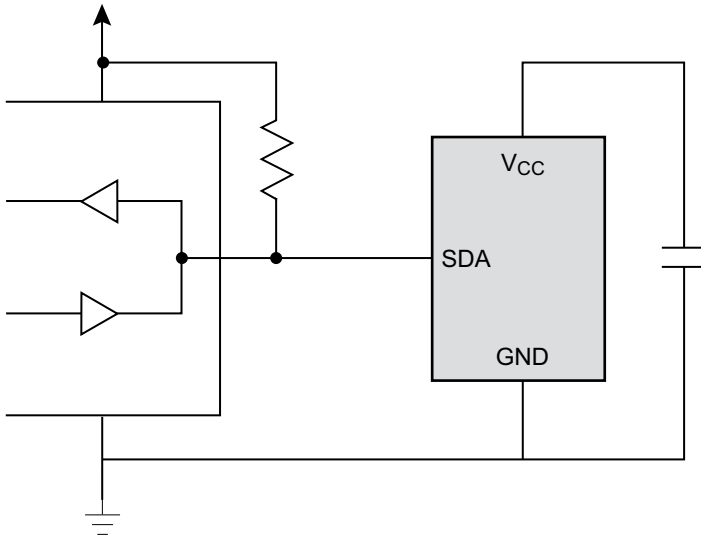

## 6. I<sup>2</sup>C Interface

The I<sup>2</sup>C interface uses the SDA and SCL pins to indicate various I/O states to the ATSHA204A. This interface is designed to be compatible at the protocol level with other I<sup>2</sup>C devices operating up to 1MHz.

The SDA pin is normally pulled high with an external pull-up resistor, as the ATSHA204A includes only an open-drain driver on its output pin. The bus master may be either open-drain or totem pole, and if the latter, then it should be tri-stated when the ATSHA204A is driving results on the bus. The SCL pin is an input, and must be driven both high and low at all times by an external device or pull-up.

### 6.1 I/O Conditions

The ATSHA204A device responds to the following I/O conditions:

#### 6.1.1 Device is Asleep

When the device is asleep, it ignores all but the wake condition

**Wake:** If SDA is held low for a period greater than  $t_{WLO}$ , the device exits low-power mode and, after a delay of  $t_{WHI}$ , is ready to receive I<sup>2</sup>C commands. The device ignores any levels or transitions on the SCL pin when the device is idle or asleep and during  $t_{WLO}$ . At some point during  $t_{WHI}$ , the SCL pin is enabled and the conditions listed in Section [Section 6.1.2, “Device is Awake”](#), are honored.

The Wake condition requires that either the system processor manually drives the SDA pin low for  $t_{WLO}$ , or that a data byte of 0x00 is transmitted at a clock rate sufficiently slow so that SDA is low for a minimum period of  $t_{WLO}$ . When the device is awake, the normal processor I<sup>2</sup>C hardware and/or software can be used for device communications up to and including the I/O sequence required to put the device back into low-power (i.e. sleep) mode.

When there are multiple ATSHA204A devices on the bus and the I<sup>2</sup>C interface is run at 133KHz or slower, the transmission of certain data patterns (such as 0x00) will cause all the ATSHA204A devices on the bus to wake-up. Because subsequent device addresses transmitted along the bus will only match the desired devices, the unused devices will remain inactive and not cause any bus conflicts.

In I<sup>2</sup>C mode, the device will ignore a wake sequence that is sent when the device is already awake.

#### 6.1.2 Device is Awake

When the device is awake, it honors the conditions listed below.

**Data Zero:** If SDA is low and stable while SCL goes from low to high to low, then a zero bit is being transferred on the bus. SDA can change while SCL is low.

**Data One:** If SDA is high and stable while SCL goes from low to high to low, then a one bit is being transferred on the bus. SDA can change while SCL is low.

**Figure 6-1. Data Bit Transfer on I<sup>2</sup>C Interface**

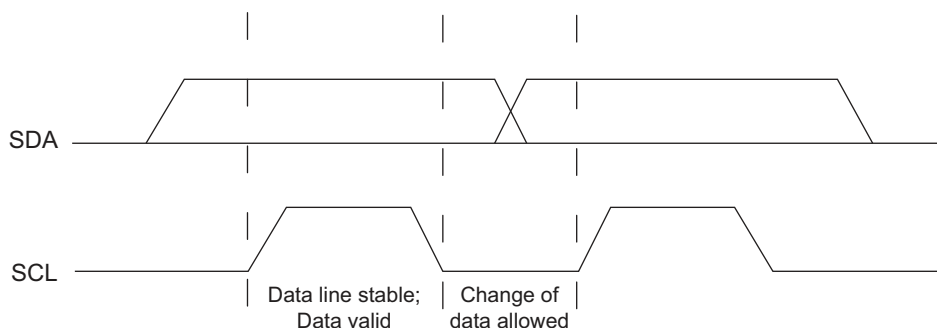

- Start:** A high-to-low transition of SDA with SCL high is a Start condition, which must precede all commands.
- Stop:** A low-to-high transition of SDA with SCL high is a Stop condition. After this condition is received by the device, the current I/O transaction ends. On input, if the device has sufficient bytes to execute a command, the device transitions to the busy state and begins execution. Atmel recommends that a Stop condition be sent after any packet is sent to the device although it may not always be required. The device will start when the correct number of bytes is received. In the case of an error on the bus, the device will reset on the watchdog timer.

**Figure 6-2. Start and Stop Conditions on I<sup>2</sup>C Interface**

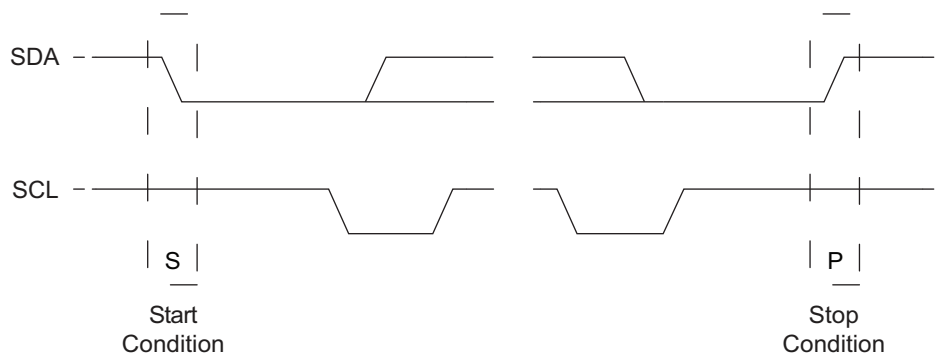

**Acknowledge (ACK):** On the ninth clock cycle after every address or data byte has been transferred, the receiver will pull the SDA pin low to acknowledge proper reception of the byte.

**Not Acknowledge (NACK):** Alternatively, on the ninth clock cycle after every address or data byte has been transferred, the receiver can leave the SDA pin high to indicate that there was a problem with the reception of the byte or that this byte completes the block transfer.

**Figure 6-3. NACK and ACK Conditions on I<sup>2</sup>C Interface**

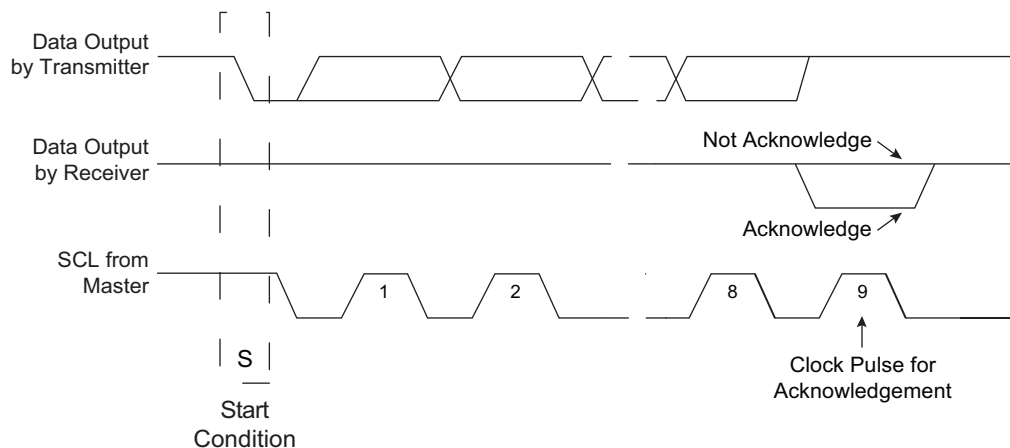

Multiple ATSHA204A devices can easily share the same I<sup>2</sup>C interface if the I<sup>2</sup>C address byte is programmed differently for each device on the bus. Because six of the bits of the device address are programmable, the ATSHA204A can also share the I<sup>2</sup>C interface with any standard I<sup>2</sup>C device, including any serial EEPROM. Bit 3 (also known as TTL Enable) must be programmed according the input thresholds desired, and it is fixed in a particular application.

## 6.2 I<sup>2</sup>C Transmission to the ATSHA204A Device

The transmission of data from the system to the AT88SA102S is summarized in Figure 6-4. The order of transmission is as follows:

1. Start Condition
2. Device Address Byte
3. Word Address Byte
4. Optional Data Bytes (1 through N)
5. Stop Condition

**Figure 6-4. Normal I<sup>2</sup>C Transmission to an ATSHA204A**

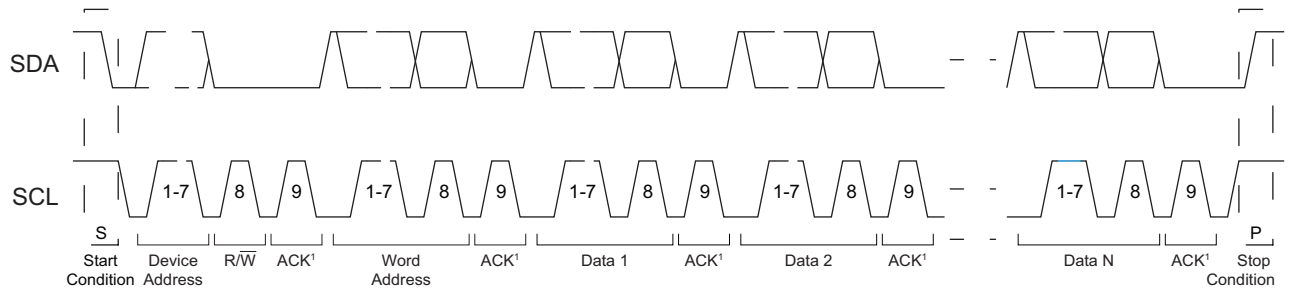

Note: SDA is driven low by the ATSHA204A during the ACK periods

The tables below label the bytes of the I/O transaction. The I<sup>2</sup>C name column provides the names of the bytes as they are described in the AT24C16 Datasheet.

**Table 6-1. I<sup>2</sup>C Transmission to the ATSHA204A**

ATSHA204A	I <sup>2</sup> C Name	Direction	Description
Device Address	Device Address	To Slave	This byte selects a particular device on the I <sup>2</sup> C interface. The ATSHA204A is selected if bits 1 thru 7 of this byte match bits 1 thru 7 of the I2C_Address byte in the Configuration zone. Bit 0 of this byte is the standard I <sup>2</sup> C R/W bit, and should be zero to indicate a Write operation (the bytes following the device address travel from the master to the slave).
Data	Data <sub>1,N</sub>	To Slave	The input block.

Because the device treats the command input buffer as a FIFO, the input block can be sent to the device in one or many I<sup>2</sup>C command blocks. The first byte sent to the device is the count, so after the device receives that number of bytes, it will ignore any subsequently received bytes until execution is finished.

The system *must* send a Stop condition after the last command byte to ensure that the ATSHA204A will start the computation of the command. Failure to send a Stop condition may eventually result in a loss of synchronization (See Section 6.5, “I<sup>2</sup>C Synchronization” for recovery procedures).

## 6.2.1 Word Address Values

During a I<sup>2</sup>C write packet, the ATSHA204A interprets the second byte sent as the word address, which indicates the packet function, as described in [Table 6-2](#).

**Table 6-2. Word Address Values**

Name	Value	Description
Reset	0x00	Reset the address counter. The next read or write transaction will start with the beginning of the I/O buffer.
Sleep (Low Power)	0x01	The ATSHA204A goes into the low-power sleep mode and ignores all subsequent I/O transitions until the next Wake flag. The entire volatile state of the device is reset.
Idle	0x02	The ATSHA204A goes into the idle state and ignores all subsequent I/O transitions until the next Wake flag. The contents of TempKey and RNG Seed registers are retained.
Command	0x03	Write subsequent bytes to sequential addresses in the input command buffer that follow previous writes. This is the normal operation.
Reserved	0x04 – 0xFF	These addresses should not be sent to the device.

## 6.2.2 Command Completion Polling

After a complete command has been sent to the ATSHA204A, the device will be busy until the command computation completes. The system has two options for this delay:

- **Polling**

The system should wait  $t_{EXEC}$  (typical) and then send a read sequence (See [Section 6.3, “I<sup>2</sup>C Transmission from the ATSHA204A Device”](#)). If the device NACKs the device address, then it is still busy. The system may delay for some time or immediately send another read sequence, again looping on NACK. After a total delay of  $t_{EXEC}$  (max), the device will have completed the computation and return the results.

- **Single Delay**

The system should wait  $t_{EXEC}$  (max), after which the device will have completed execution and the result can be read from the device using a normal read sequence.

## 6.3 I<sup>2</sup>C Transmission from the ATSHA204A Device

When the ATSHA204A is awake and not busy, the bus master can retrieve the current buffer contents from the device using an I<sup>2</sup>C read. If valid command results are available, the size of the block returned is determined by the particular command that has been run (See [Section 8., “Security Commands”](#)); otherwise, the size of the block (and the first byte returned) will always be four: count, status/error, and 2-byte CRC. The bus timing is shown in [Figure 7-3](#).

**Table 6-3. I<sup>2</sup>C transmission from ATSHA204A**

ATSHA204A	I <sup>2</sup> C Name	Direction	Description
Device Address	Device Address	To Slave	This byte selects a particular device on the I <sup>2</sup> C interface, and the ATSHA204A will be selected if bits 1 thru 7 of this byte match bits 1 thru 7 of the I2C_Address byte in the Configuration zone. Bit 0 of this byte is the standard I <sup>2</sup> C R/W pin, and should be one to indicate that the bytes following the device address travel from the slave to the master (read).
Data	Data <sub>1,N</sub>	To Master	The output block, consisting of the count and status/error byte or the output packet followed by the 2-byte CRC per <a href="#">Section 8.2</a> .

The status, error, or command outputs can be read repeatedly by the master. Each time a read command is sent to the ATSHA204A along the I<sup>2</sup>C interface, the device transmits the next sequential byte in the output buffer. See the following section for details on how the device handles the address counter.

If the ATSHA204A is busy, idle, or asleep, it will NACK the device address on a read sequence. If a partial command has been sent to the device, then it will NACK the device address, but float the bus during the data intervals.

## 6.4 Address Counter

Writes to and/or reads from the ATSHA204A I/O buffer over the I<sup>2</sup>C interface are treated as if the device were a FIFO. Either the I<sup>2</sup>C byte or block write/read protocols can be used. The number of bytes transferred with each block sequence does not affect the operation of the device.

The first byte transmitted to the device is treated as the count byte. Any attempt to send more than this number of bytes or any attempts to write beyond the end of the I/O buffer (84 bytes) will cause the ATSHA204A to NACK those bytes.

After the Host writes a single command byte to the input buffer, reads from the Host are prohibited until after the device completes command execution. Attempts to read from the device prior to the last command byte being sent will result in an ACK of the device address but all ones (0xFF) on the bus. If the master attempts to send a read byte to the device during command execution, the device will NACK the device address.

Data may be read from the device under the following three conditions:

- Upon power-up, the single byte, 0x11 (See [Section 8.5.2, “Command Opcodes, Short Descriptions, and Execution Times”](#)), can be read inside a four byte block.
- If a complete block has been received by the device, but there are any errors in parsing or executing the command, a single byte of error code will be available, also inside a four byte block.
- Upon completion of command execution, from 1 to 32 bytes of command result will be available to be read inside a block of 4 to 35 bytes.

Any attempt to read beyond the end of the valid output buffer returns 0xFF to the system, and the address counter does not wrap around to the beginning of the buffer.

There may be situations where the system may wish to re-read the output buffer, for example when the CRC check reveals an error. In this case, the master should send a two-byte sequence to the ATSHA204A consisting of the correct device address and a word address of 0x00 (Reset, per [Table 8.1](#)), followed by a Stop condition. This causes the address counter to be reset to zero, and permits the data to be re-written (re-read) to (from) the device. This address reset sequence does not prohibit subsequent read operations if data were available for reading in the I/O buffer prior to the sequence execution.

After one or more Read operations to retrieve the results of a command execution, the first Write operation resets the address counter to the beginning of the I/O buffer.

## 6.5 I<sup>2</sup>C Synchronization

It is possible for the system to lose synchronization with the I/O port on the ATSHA204A, for example due a system reset, I/O noise, or some other condition. Under this circumstance, the ATSHA204A may not respond as expected, may be asleep, or may be transmitting data during an interval when the system is expecting to send data. Any command results in the I/O buffer may be lost when the system and device lose synchronization.

To re-synchronize, the following procedure should be followed:

1. To ensure an I/O channel reset, the system should send the standard I<sup>2</sup>C software reset sequence, as follows:
  - A Start condition.
  - Nine cycles of SCL with SDA held high.
  - Another Start condition.
  - A Stop condition.

It should then be possible to send a read sequence, and if synchronization has completed properly, the ATSHA204A will ACK the device address. The device may return data or may leave the bus floating (which the system will interpret as a data value of 0xFF) during the data periods.

If the device does ACK the device address, the system should reset the internal address counter to force the ATSHA204A to ignore any partial input command that may have been sent. This can be accomplished by sending a write sequence to word address 0x00 (Reset), followed by a Stop condition.

2. If the device does *not* respond to the device address with an ACK, then it may be asleep. In this case, the system should send a complete wake token and wait  $t_{WHI}$  after the rising edge. The system may then send another read sequence, and, if synchronization has completed, the device will ACK the device address.
3. If the device still does not respond to the device address with an ACK, then it may be busy executing a command. The system should wait the longest  $t_{EXEC}$  (max) and then send the read sequence, which will be acknowledged by the device.

## 6.6 Transaction Example

Figure 6-5. Wake (I<sup>2</sup>C)

Host		Device
Start	→	
Wake	→	
Stop	→	
Start	→	
Slave Address / R	→	
	←	Data
Stop	→	

Figure 6-6. Example (I<sup>2</sup>C)

Host		Device
Start	→	
Wake	→	
Stop	→	
Start	→	
Slave Address / R	→	
	←	Data
Stop	→	
Start	→	
Slave Address / W	→	
Command	→	
Data	→	
Stop	→	
Start	→	
Slave Address / R	→	
	←	Data
Stop	→	
Start	→	
Slave Address / W	→	
Idle / Sleep	→	
Stop	→	



## 7. Electrical Characteristics

### 7.1 Absolute Maximum Ratings\*

Operating Temperature . . . . .	-40°C to +85°C
Storage Temperature . . . . .	-65°C to + 150°C
Maximum Operating Voltage . . . . .	6.0V
DC Output Current . . . . .	5.0mA
Voltage on any pin . . . . .	-0.5V to (V <sub>CC</sub> + 0.5V)

\*Notice: Stresses beyond those listed under “Absolute Maximum Ratings” may cause permanent damage to the device. This is a stress rating only, and functional operation of the device at these or any other condition beyond those indicated in the operational sections of this specification is not implied. Exposure to absolute maximum rating conditions for extended periods may affect device reliability.

### 7.2 Reliability

The ATSHA204A is fabricated with the high reliability of the Atmel CMOS EEPROM manufacturing technology.

Table 7-1. EEPROM reliability

Parameter	Min	Typical	Max	Units
Write Endurance (each byte at 25°C)	100,000			Write Cycles
Data Retention (at 55°C)	10			Years
Data Retention (at 35°C)	30	50		Years
Read Endurance	Unlimited			Read Cycles

### 7.3 AC Parameters — All I/O Interfaces

Figure 7-1. AC Timing Diagram — All I/O Interfaces

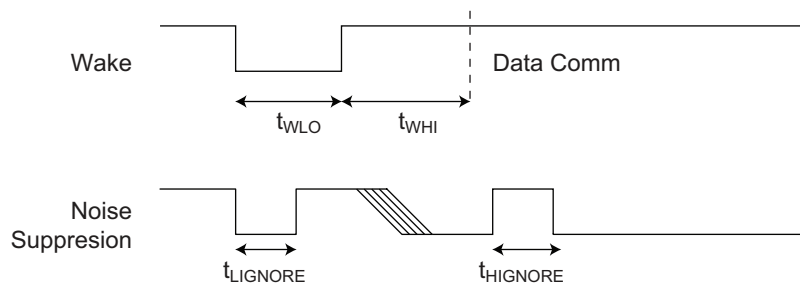

**Table 7-2. AC Parameters — All I/O Interfaces**

Parameter	Symbol	Direction	Min	Typ	Max	Unit	Notes
Wake Low Duration	$t_{WLO}$	To Crypto Authentication	60		—	$\mu\text{s}$	SDA can be stable in either high or low levels during extended sleep intervals.
Power-Up Delay	$t_{PU}$	To Crypto Authentication	100 <sup>(1)</sup>			$\mu\text{s}$	Minimum time between $V_{CC} > V_{CC}$ min prior to measurement of $t_{WLO}$ .
Wake High Delay to Data Comm.	$t_{WHI}$	To Crypto Authentication	2.5			ms	SDA should be stable high for this entire duration.
High Side Glitch Filter @ Active	$t_{HIGNORE\_A}$	To Crypto Authentication	45			ns	Pulses shorter than this in width will be ignored by the device, regardless of its state when active.
Low Side Glitch Filter @ Active	$t_{LIGNORE\_A}$	To Crypto Authentication	45			ns	Pulses shorter than this in width will be ignored by the device, regardless of its state when active.
High Side Glitch Filter @ Sleep	$t_{HIGNORE\_S}$	To Crypto Authentication	15			$\mu\text{s}$	Pulses shorter than this in width will be ignored by the device when in sleep mode.
Low Side Glitch Filter @ Sleep	$t_{LIGNORE\_S}$	To Crypto Authentication	15			$\mu\text{s}$	Pulses shorter than this in width will be ignored by the device when in sleep mode.
Watchdog Reset	$t_{WATCHDOG}$	To Crypto Authentication	0.7 <sup>(1)</sup>	1.3	1.7	s	Max. time from wake until device is forced into sleep mode (See <a href="#">Section 8.4, "Watchdog Failsafe"</a> ).

Note: 1. These parameters are guaranteed through characterization, but not tested.

### 7.3.1 AC Parameters — Single-Wire Interface

**Figure 7-2. AC Timing Diagram — Single-Wire Interface**

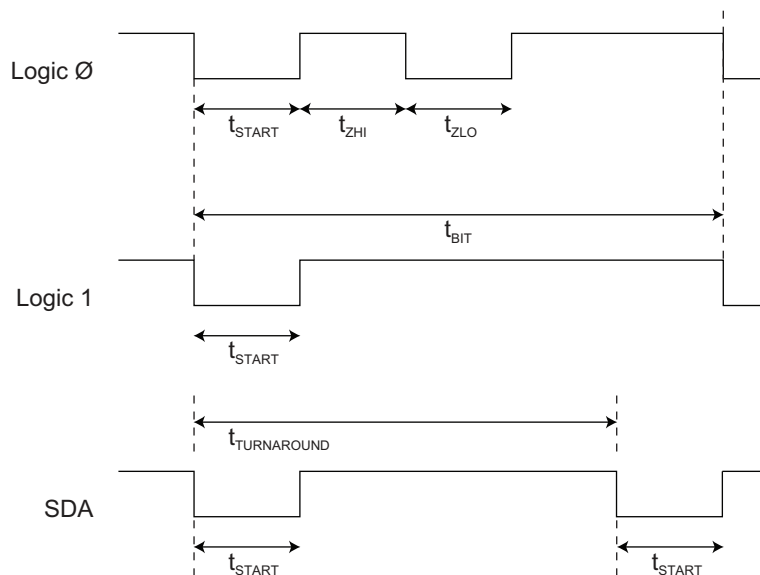

**Table 7-3. AC Parameters — Single-Wire Interface**Applicable from  $T_A = -40^{\circ}\text{C}$  to  $+85^{\circ}\text{C}$ ,  $V_{CC} = +2.0\text{V}$  to  $+5.5\text{V}$ ,  $CL = 100\text{pF}$  (unless otherwise noted).

Parameter	Symbol	Direction	Min	Typ	Max	Unit	Notes
Start Pulse Duration	$t_{\text{START}}$	To Crypto Authentication	4.10	4.34	4.56	$\mu\text{s}$	
		From Crypto Authentication	4.60	6.00	8.60	$\mu\text{s}$	
Zero Transmission High Pulse	$t_{\text{ZHI}}$	To Crypto Authentication	4.10	4.34	4.56	$\mu\text{s}$	
		From Crypto Authentication	4.60	6.00	8.60	$\mu\text{s}$	
Zero Transmission Low Pulse	$t_{\text{ZLO}}$	To Crypto Authentication	4.10	4.34	4.56	$\mu\text{s}$	
		From Crypto Authentication	4.60	6.00	8.60	$\mu\text{s}$	
Bit Time <sup>(1)</sup>	$t_{\text{BIT}}$	To Crypto Authentication	37	39	—	$\mu\text{s}$	If the bit time exceeds $t_{\text{TIMEOUT}}$ , then the ATSHA204A may enter the sleep state. See <a href="#">Section 5.3.1, “I/O Timeout”</a> for specific details.
		From Crypto Authentication	41	54	78	$\mu\text{s}$	
Turnaround Delay	$t_{\text{TURNAROUND}}$	From Crypto Authentication	64	80	131	$\mu\text{s}$	The ATSHA204A will initiate the first low-going transition after this time interval following the start of the last bit ( $t_{\text{BIT}}$ ) of the Transmit flag.
		To Crypto Authentication	93			$\mu\text{s}$	After the ATSHA204A transmits the last bit of a block, the system must wait this interval before sending the first bit of a flag.
I/O Timeout	$t_{\text{TIMEOUT}}$	To Crypto Authentication	45	65	85	ms	The ATSHA204A may transition to the sleep state if the bus is inactive longer than this duration. See <a href="#">Section 5.3.1, “I/O Timeout”</a> for specific details.

Note: 1.  $t_{\text{START}}$ ,  $t_{\text{ZLO}}$ ,  $t_{\text{ZHI}}$ , and  $t_{\text{BIT}}$  are designed to be compatible with a standard UART running at 230.4Kbaud for both transmit and receive. The UART should be set to seven data bits, no parity, and one stop bit.

### 7.3.2 AC Parameters — I<sup>2</sup>C Interface

Figure 7-3. I<sup>2</sup>C Synchronous Data Timing

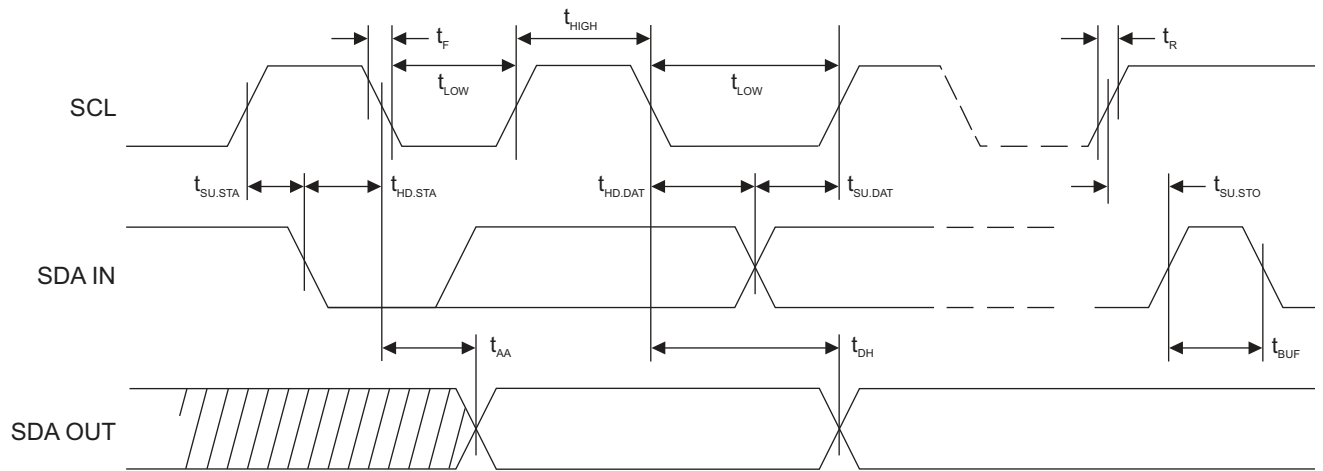

Table 7-4. AC Characteristics of the I<sup>2</sup>C Interface

Applicable over recommended operating range from  $T_A = -40^{\circ}\text{C}$  to  $+85^{\circ}\text{C}$ ,  $V_{CC} = +2.0\text{V}$  to  $+5.5\text{V}$ ,  $CL = 1$  TTL gate and  $100\text{pF}$  (unless otherwise noted).

Symbol	Parameter	Min	Max	Units
$f_{\text{SCK}}$	SCK Clock Frequency		1000	kHz
	SCK Clock Duty Cycle	30	70	percent
$t_{\text{HIGH}}$	SCK High Time	400		ns
$t_{\text{LOW}}$	SCK Low Time	400		ns
$t_{\text{SU.STA}}$	Start Setup Time	250		ns
$t_{\text{HD.STA}}$	Start Hold Time	250		ns
$t_{\text{SU.STO}}$	Stop Setup Time	250		ns
$t_{\text{SU.DAT}}$	Data in Setup Time	100		ns
$t_{\text{HD.DAT}}$	Data in Hold Time	0		ns
$t_{\text{R}}$	Input rise time <sup>(1)</sup>		300	ns
$t_{\text{F}}$	Input Fall Time <sup>(1)</sup>		100	ns
$t_{\text{AA}}$	Clock Low to Data Out Valid	50	550	ns
$t_{\text{DH}}$	Data Out Hold Time	50		ns
$t_{\text{BUF}}$	Time bus must be free before a new transmission can start. <sup>(1)</sup>	500		ns

Note: 1. Values are based on characterization, but are not tested.

AC measurement conditions:

- $R_L$  (connects between SDA and  $V_{CC}$ ):  $1.2\text{k}\Omega$  (for  $V_{CC} +2.0\text{V}$  to  $+5.0\text{V}$ )
- Input pulse voltages:  $0.3V_{CC}$  to  $0.7V_{CC}$
- Input rise and fall times:  $\leq 50\text{ns}$
- Input and output timing reference voltage:  $0.5V_{CC}$

## 7.4 DC Parameters — All I/O Interfaces

Table 7-5. DC Parameters on All I/O Interfaces

Parameter	Symbol	Min	Typ	Max	Unit	Notes
Ambient Operating Temperature	$T_A$	-40		85	°C	
Power Supply Voltage	$V_{CC}$	2.0		5.5	V	
Active Power Supply Current	$I_{CC}$		500		$\mu\text{A}$	$0^\circ\text{C} \rightarrow +70^\circ\text{C}$ , $V_{CC} = 3.3\text{V}$ .
			—	2	mA	$-40^\circ\text{C} \rightarrow +85^\circ\text{C}$ , $V_{CC} = 5.5\text{V}$ .
Idle Power Supply Current	$I_{IDLE}$		200		$\mu\text{A}$	When device is in idle mode, $V_{CC} = 3.3\text{V}$ , $V_{SDA}$ and $V_{SCL} < 0.3\text{V}$ or $>> V_{CC}-0.3$ .
Sleep Current	$I_{SLEEP}$		30	150	nA	When device is in sleep mode, $V_{CC} \leq 3.6\text{V}$ , $V_{SDA}$ and $V_{SCL} < 0.3\text{V}$ or $> V_{CC}-0.3$ , $T_A \leq 55^\circ\text{C}$
				2	$\mu\text{A}$	When device is in sleep mode; all operating conditions.
Output Low Voltage	$V_{OL}$			0.4	V	When device is in active mode, $V_{CC} = 2.5 - 5.5\text{V}$ .
Output Low Current	$I_{OL}$			4	mA	When device is in active mode, $V_{CC} = 2.5 - 5.5\text{V}$ , $V_{OL} = 0.4\text{V}$ .

### 7.4.1 $V_{IH}$ and $V_{IL}$ Specifications

The input voltage thresholds when in sleep or idle mode are dependent on the  $V_{CC}$  level as shown in the graph below. When the device is active (i.e. not in sleep or idle mode), the input voltage thresholds are different, depending on the state of TTLenable (bit 3) within the I2C\_Address byte stored in the Configuration zone of the EEPROM. When a common voltage is used for the ATSHA204A  $V_{CC}$  pin and the input pull-up resistor, then this bit should be set to a one, which permits the input thresholds to track the supply as shown in the graph below.

Figure 7-4.  $V_{IH}$  and  $V_{IL}$  When TTLenable = 1 on All I/O Interfaces

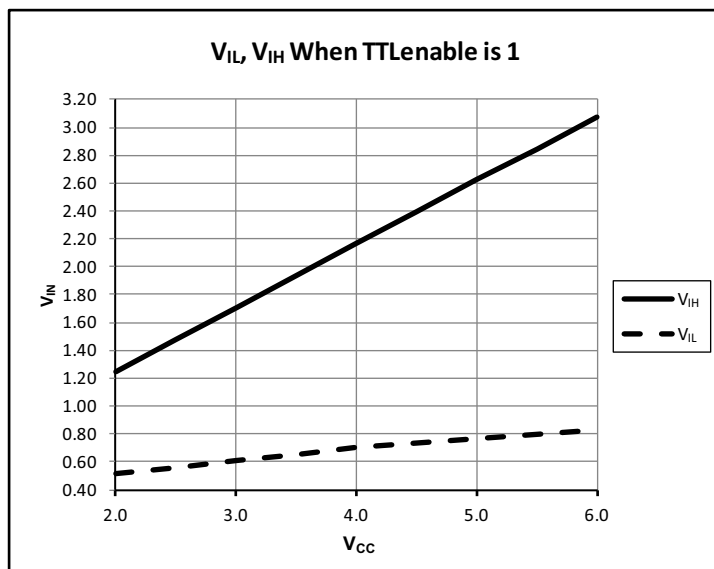

If the voltage supplied to the  $V_{CC}$  pin of the ATSHA204A is different from the system voltage to which the input pull-up resistor is connected, then the system designer may choose to set TTLenable to zero, which enables a fixed input threshold according to the following table.

**Table 7-6.  $V_{IL}$  and  $V_{IH}$  When TTLenable = 0 on All I/O Interfaces**

Parameter	Symbol	Min	Typ	Max	Unit	Notes
Input Low Voltage	$V_{IL}$	GND - 0.5		0.5	V	When device is active and TTLenable bit in configuration memory is zero; otherwise, see above.
Input High Voltage	$V_{IH}$	1.5		$V_{CC} + 0.5$	V	When device is active and TTLenable bit in configuration memory is zero; otherwise, see above.

## 8. Security Commands

### 8.1 I/O Blocks

Regardless of the I/O protocol being used (i.e. Single-Wire or I<sup>2</sup>C), commands are sent to the device, and responses received from the device, within a block that is constructed in the following way:

**Table 8-1. Blocks**

Byte	Name	Meaning
0	Count	Packet size. Includes Count, Data, and Checksum.
1 to N-2	Data	If device input; commands and parameters. If device output; response from the device based on the Command being called.
N-1 to N	Checksum	CRC-16. The CRC polynomial is 0x8005.

The ATSHA204A is designed in such a way that the count value in the input block should be consistent with the size requirements specified in the command parameters. If the count value is inconsistent with the command opcode and/or parameters within the packet, then the ATSHA204A will respond in different ways, depending upon the specific command. Either the response will include an error indication or some input bytes will be silently ignored.

#### 8.1.1 Status/Error Codes

The device does not have a dedicated status register, so the output FIFO is shared among status, error, and command results. All output from the device is returned to the system as complete blocks.

After the device receives the first byte of an input command block, the system cannot read anything from the device until the system has sent all the bytes to the device.

After wake and after execution of a command, there will be error, status, or result bytes in the device's output register that can be retrieved by the system. When the length of that block is four bytes, the codes returned will be as detailed in [Table 8-2](#). Some commands return more than four bytes when they execute successfully. The resulting packet description is listed in the command section below.

CRC errors are always returned before any other type of error. They indicate that some sort of I/O error occurred and that the command may be resent to the device. If a command includes both parse and execution errors, then there no particular precedence will be enforced, so an execution error may occur before a parse, error, and/or the reverse may occur.

**Table 8-2. Status/Error Codes in 4-byte Blocks**

State Description	Error/Status	Description
Successful Command Execution	0x00	Command executed successfully.
Checkmac Miscompare	0x01	The CheckMac command was properly sent to the device, but the input Client response did not match the expected value.
Parse Error	0x03	Command was properly received, but the length, command opcode, or parameters are illegal, regardless of the state (volatile and/or EEPROM configuration) of the ATSHA204A. Changes in the value of the command bits must be made before it is re-attempted.
Execution Error	0x0F	Command was properly received, but could not be executed by the device in its current state. Changes in the device state or the value of the command bits must be made before it is re-attempted.
After Wake, Prior to First Command	0x11	Indication that the ATSHA204A has received a proper Wake token.
CRC or other Communications Error	0xFF	Command was <i>not</i> properly received by the ATSHA204A, and should be re-transmitted by the I/O driver in the system. No attempt was made to parse or execute the command.

## 8.2 Sleep Sequence

Upon completion of system use of the ATSHA204A, the system should issue a sleep sequence to put the device into low-power mode. Using the I<sup>2</sup>C interface, this sequence consists of the proper device address followed by the sleep flag followed by a Stop condition. This transition to the low-power state causes a complete reset of the device's internal command engine and input/output buffer. It can be sent to the device at any time when it is awake and not busy.

## 8.3 Idle Sequence

If the total sequence of required commands exceeds  $t_{\text{WATCHDOG}}$ , then the device will automatically go to sleep and lose any information stored in the volatile registers. This action can be prevented by putting the device into the idle state prior to completion of the watchdog interval. When the device receives the Wake token, it will then restart the watchdog timer, and execution can be continued.

Using the I<sup>2</sup>C interface, this idle sequence consists of the proper device address followed by the value of 0x02 as the word address followed by a Stop condition. It can be sent to the device at any time when it is awake and not busy.

If TempKey was created as a result of the copy mode of the CheckMac command, it will *not* be retained when the part goes into an idle state.



## 8.4 Watchdog Failsafe

A watchdog counter starts within the device after the ATSHA204A receives a Wake token. After  $t_{\text{WATCHDOG}}$ , the device enters sleep mode regardless of whether some I/O transmission or command execution is in progress. There is no way to reset the counter other than to put the device into sleep or idle mode and then wake it up again.

The watchdog timer is implemented as a failsafe mechanism so that no matter what happens on either the system side or inside the device, including any I/O synchronization issue, power consumption will fall to the ultra-low sleep level automatically.

The device resets the values stored in the SRAM and internal status registers when it transitions to the sleep state, however if the device is explicitly put into the idle mode through the appropriate I/O sequence, the device will retain the contents of the two SRAM registers (i.e. TempKey and RNG seed).

Normally, all command sequences must complete within  $t_{\text{WATCHDOG}}$  if they require a state that is stored in the SRAM registers. The system software can use this idle mode mechanism between commands to implement a longer command sequence than can be completed during a single watchdog interval.

## 8.5 Command Sequence

### 8.5.1 Command Packets

The command packet is broken down as shown in [Table 8-3](#).

**Table 8-3. Command Packets**

Byte #	Name	Meaning
0	Command	Command Flag (see <a href="#">Table 8.1</a> ). Not included in Count or CRC field.
1	Count	Packet size. Includes Count, Opcode, Param1, Param2, Data, and CRC. Does not include Command Flag.
2	Opcode	ATSHA204A operation being called.
3	Param1	First Parameter. One byte always present.
4 – 5	Param2	Second Parameter. Two bytes always present.
	Data	Optional Data based on Command being called.
N-1to N	Checksum	CRC-16. The CRC polynomial is 0x8005. Includes Count, Opcode, Param1, Param2, and Data. Does not include Command Flag.

After the ATSHA204A receives all the bytes in a block, the device transitions to the busy state and attempts to execute the command. Neither status nor results can be read from the device when it is busy. During this time, the device's I/O interface ignores all SDA transitions regardless of the I/O interface selected. The command execution delays are listed in [Section 8.5.15.1, "Read Operations within the Data Zone"](#).

If an insufficient number of bytes are sent to the device when it is in one-wire mode, the device automatically transitions to the low-power sleep state after the  $t_{\text{TIMEOUT}}$  interval. In I<sup>2</sup>C mode, the device continues to wait for the remaining bytes until the watchdog timer limit,  $t_{\text{WATCHDOG}}$ , is reached or a Start/Stop condition is received by the device.

In the individual command descriptions in [Table 8-8](#) through [Table 8-39](#), the size column describes the number of bytes in the parameter documented in each particular row. If the input block size for a particular command is incorrect, then the device will respond differently depending upon the command. It may not return an error indication in all circumstances (see [Section 8.1.1, "Status/Error Codes"](#)).

## 8.5.2 Command Opcodes, Short Descriptions, and Execution Times

During parsing of the parameters and the subsequent execution of a properly received command, the device will be busy and not respond to transitions on the pins. The interval during which the device will be busy varies depending upon the command and its parameter values, the state of the device, the environmental conditions, and other factors according to [Table 8-4](#).

In most but not all cases, failing commands will return relatively quickly, often well before the typical execution time.

**Table 8-4. Command Opcodes, Short Descriptions, and Execution Times**

Command	Opcode	Description	Typ. Exec. Time <sup>(1)</sup> , ms	Max. Exec. Time <sup>(2)</sup> , ms
DeriveKey	0x1C	Derive a target key value from the target or parent key.	14	62
DevRev	0x30	Return device revision information.	0.4	2
GenDig	0x15	Generate a data protection digest from a random or input seed and a key.	11	43
HMAC	0x11	Calculate response from key and other internal data using HMAC/SHA-256.	27	69
CheckMac	0x28	Verify a MAC calculated on another Atmel CryptoAuthentication device.	12	38
Lock	0x17	Prevent further modifications to a zone of the device.	5	24
MAC	0x08	Calculate response from key and other internal data using SHA-256.	12	35
Nonce	0x16	Generate a 32-byte random number and an internally stored nonce.	22	60
Pause	0x01	Selectively put just one device on a shared bus into the idle state.	0.4	2
Random	0x1B	Generate a random number.	11	50
Read	0x02	Read four bytes from the device, with or without authentication and encryption.	0.4	4
SHA	0x47	Calculate a SHA256 digest for any system purpose.	11	22
UpdateExtra	0x20	Update bytes 84 or 85 within the Configuration zone after the Configuration zone is locked.	8	12
Write	0x12	Write 4 or 32 bytes to the device, with or without authentication and encryption.	4	42

- Notes:
1. Typical execution times are representative of the duration to execute the command assuming no error conditions, fastest mode setting, no optional internal actions such as limited use keys, and favorable environmental conditions. For best performance, delay for this interval and then start polling to determine actual command completion.
  2. Maximum execution times are representative of the longest duration of a successful command execution with all mode and internal actions enabled under extended statistical and environmental conditions. Execution time may extend beyond these values in extreme situations.

### 8.5.3 Zone Encoding

The value in Param1 for both the Read command and the Write command controls which zone the command will access. See [Section 2.1.4.1, “Configuration Zone Locking”](#) to obtain more information on what controls the “locked” and “unlocked” states for each zone. All other zone values are reserved, and should not be used.

**Table 8-5. Zone Encoding (Param1)**

Zone Name	Param1 Value	Size	Read	Write
Config	0	704 bits 88 bytes 3 slots	Always available.	Partially, when unlocked. Never when locked. Never encrypted.
OTP	1	512 bits 64 bytes 2 slots	Never when unlocked. Always when locked, except in legacy mode. See <a href="#">Section 2.1.3, “One Time Programmable (OTP) Zone”</a> .	Not allowed when LockConfig is unlocked. All writeable when LockConfig is locked and LockValue is unlocked. Controlled by OTPmode when LockValue is locked. See <a href="#">Section 2.1.3</a> .
Data	2	4096 bits 512 bytes 16 slots	Never when unlocked; otherwise, controlled by IsSecret and EncryptRead.	Not allowed when LockConfig is unlocked. All writeable when LockConfig is locked and LockValue is unlocked. Controlled by WriteConfig when LockValue is locked. See <a href="#">Section 2.1.4</a> .

## 8.5.4 Address Encoding

Param2 includes a single address that indicates the memory to be accessed. All Reads and Writes are in units of Words (4-byte). The most-significant byte of a legal ATSHA204A address is always zero. All unused address bits should always be set to zero. The least-significant bits in the address describe the offset to the first word to be accessed within the Block/Slot, while the upper bits specify the Slot number per the table below:

**Table 8-6. Address Encoding (Param2)**

Zone	Byte 0 (First Byte on the Bus)								Byte 1								
	7	6	5	4	3	2	1	0	7	6	5	4	3	2	1	0	
Data	0	Block				Offset				0	0	0	0	0	0	0	0
Config	0	0	0	Block		Offset				0	0	0	0	0	0	0	0
OTP	0	0	0	0	Block	Offset				0	0	0	0	0	0	0	0

Within each zone, there are various access restrictions per the table below:

**Table 8-7. Legal Block/slot Values**

Zone	Legal Block/Slot (Inclusive)	Notes
Data	0 – 15	All offsets in all slots available for both read and write. 4-byte access permitted on a particular slot only if SlotConfig.IsSecret is zero.
Config	0 – 2	Words above 16 (block 2, offset 6) can never be read. Words above 10 (block 2, offset 0) read and write must be in Word (4-byte) mode. Words below 04 (block 0, offset 4) and above 15 (block 2, offset 5) can never be written.
OTP	0 – 1	When OTPmode is read-only, all offsets in both blocks are available to use with 4-byte and 32-byte reads. If OTPmode is consumption, then writes are also permitted to all offsets. See <a href="#">Section 2.1.3, “One Time Programmable (OTP) Zone”</a> if OTPmode is Legacy.

## 8.5.5 CheckMac Command

The `CheckMac` command calculates a MAC response that had been generated on a `CryptoAuthentication` device and compares the MAC response with some input value. It returns a Boolean result to indicate the success or failure of the comparison.

Prior to running this command, the `Nonce` and/or `GenDig` commands may have been optionally run to create and load a key or nonce value in `TempKey`. The mode parameter determines the source of the “key” (the first 32-bytes of the SHA message) and “challenge/nonce” (the second-32 bytes of the SHA message).

Mode:2 controls the requirement for a random nonce if `TempKey` is part of the computed value. If the bit is one, then `TempKey` must be generated using `Nonce(Fixed)`; if it is zero, then `TempKey` must be generated using `Nonce(Random)`.

Note: Setting the bit to one may enable replay attacks in some situations.

If the comparison matches, then the target slot value may be copied into `TempKey`. If `SlotID` is even, then the target slot is `SlotD+1`, or else the target slot is `SlotID`. For the copy to take place, the following conditions must be true. If they are not all true, then the ATSHA204A will return the comparison result but not copy the key value.

1. The mode parameter to `CheckMac` must have a value of `0x01` or `0x05`.
2. `SlotConfig.ReadKey` for the target key must be zero.
3. The bit in `Config.CheckMacSource` corresponding to the key slots must have a value that matches `Mode:2`.

**Table 8-8. Input parameters**

	Name	Size	Notes
Opcode	CHECKMAC	1	0x28
Param1	Mode	1	Bit 0: Source of the second 32-bytes of the SHA message. 0: ClientChal parameter 1: TempKey  Bit 1: Source of the first 32-bytes of the SHA message. 0: Slot[SlotID] 1: TempKey  Bit 2: If TempKey is used, this bit must match the value of TempKey.SourceFlag. Bit 3-4: Must be zero.  Bit 5: 8-bytes of SHA message. 0: zeros 1: OTP zone  Bits 6-7: Must be zero.
Param2	SlotID	2	Which internal slot is to be used to generate the response. Only bits 0:3 are used.
Data1	ClientChal	32	Challenge sent to Client. ( <i>Must</i> appear in the input stream).
Data2	ClientResp	32	Response generated by the Client.
Data3	OtherData	13	Remaining constant data needed for response calculation.

**Table 8-9. Output parameter**

Name	Size	Notes
Result	1	Returns a 1-byte value of zero if <code>ClientResp</code> matches the internally computed digest, one if there is a mismatch.

The message that will be hashed with the SHA-256 algorithm consists of the following information:

32 bytes	key[SlotID] or TempKey (Depending on the mode.)
32 bytes	ClientChal or TempKey (Depending on the mode.)
4 bytes	OtherData[0:3]
8 bytes	OTP[0:7] or zeros (Depending on the mode.)
3 bytes	OtherData[4:6]
1 byte	SN[8]
4 bytes	OtherData[7:10]
2 bytes	SN[0:1]
2 bytes	OtherData[11:12]

The purpose of OtherData is to construct a SHA-256 message that will match identically to the MAC message that was used to produce ClientResp. By comparing the message used for the SHA-256 of the MAC command, OtherData is parsed as follows:

**Table 8-10. OtherData**

Size	CheckMac	MAC	Notes
1	OtherData[0]	OpCode	MAC OpCode = 08
1	OtherData[1]	Mode	Mode used for MAC command.
2	OtherData[2:3]	SlotID	SlotID used for MAC command.
3	OtherData[4:6]	OTP[8:10]	OTP[8:10] used for MAC command. (Useful for Legacy.)
4	OtherData[7:10]	SN[4:7]	SN[4:7] used for MAC command. (Unique per Client.)
2	OtherData[11:12]	SN[2:3]	SN[2:3] used for MAC command. (Unique per Client.)

**Figure 8-1. Data Flow for CheckMAC Command**

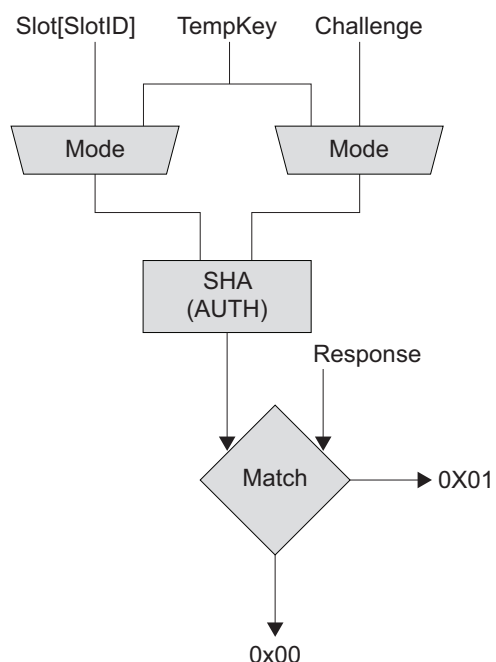

## 8.5.6 DeriveKey Command

The device combines the current value of a key with the Nonce stored in TempKey using SHA-256, and places the result into the target key slot. SlotConfig[TargetKey].Bit 13 must be set or DeriveKey will return an error.

If SlotConfig[TargetKey].Bit12 is zero, the source key that will be combined with TempKey is the target key specified in the command line (Roll-Key operation). If SlotConfig[TargetKey].Bit12 is one, the source key is the parent key of the target key, which is found in SlotConfig[TargetKey].WriteKey (Create Key operation).

Prior to execution of the DeriveKey command, the Nonce command must have been run to create a valid nonce in TempKey. Depending upon the state of bit two of the input mode, this nonce would have been created with the internal RNG, or it would have been fixed.

If SlotConfig[TargetKey].Bit15 is set, an input MAC must be present and had been computed as follows:

SHA-256(ParentKey, Opcode, Param1, Param2, SN[8], SN[0:1])  
*where the ParentKey ID is always SlotConfig[TargetKey].WriteKey.*

If SlotConfig[TargetKey].Bit12 or SlotConfig[TargetKey].Bit15 is set and SlotConfig[ParentKey].SingleUse is also set, DeriveKey returns an error if UseFlag[ParentKey] is 0x00. DeriveKey ignores SingleUse and UseFlag for the target key if SlotConfig[TargetKey].Bit12 and SlotConfig[TargetKey].Bit15 are both zero.

For slots 0 thru 7 only, if input parsing and the optional MAC check succeed, UseFlag[TargetKey] gets set to 0xFF and UpdateCount[TargetKey] is incremented. If UpdateCount currently has a value of 255, then it wraps to zero. If the command fails for any reason, these bytes will not be updated. The value of UpdateCount may be corrupted if power is interrupted during the execution of DeriveKey.

**Note:** If the source and target keys are the same, there is a risk of permanent loss of the key value if power is interrupted during the Write operation. If the configuration bits permit it, then the key slot may be recovered using an authenticated and encrypted write based upon the parent key.

**Table 8-11. Input Parameters**

	Name	Size	Notes
Opcode	DERIVEKEY	1	0x1C
Param1	Random	1	Bit 2: The value of this bit must match the value in TempKey.SourceFlag or the command will return an error. Bits 0:1, 3:7: Must be zero.
Param2	TargetKey	2	Key slot to be written.
Data	Mac	0 or 32	Optional MAC used to validate operation.

**Table 8-12. Output parameter**

Name	Size	Notes
Success	1	Upon successful completion, the ATSHA204A returns a value of zero.

The key written to the target slot is the result of a SHA-256 of the following message:

32 bytes	Target or parent key (depending on SlotConfig Bit12)
1 byte	Opcode
1 byte	Param1
2 bytes	Param2
1 byte	SN[8]
2 bytes	SN[0:1]
25 bytes	Zeros
32 bytes	TempKey.value

The data flow for this command is shown graphically in the figure below:

**Figure 8-2. Data Flow for DeriveKey Command**

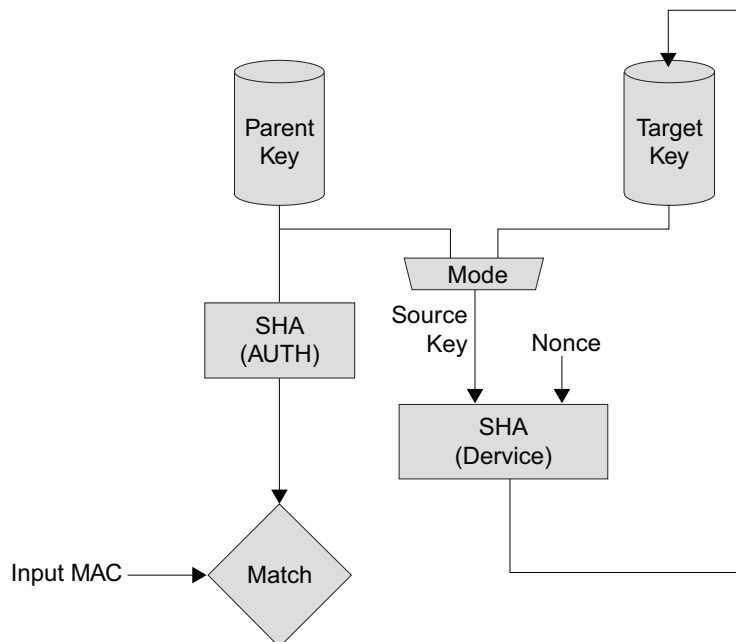



### 8.5.7 DevRev Command

DevRev command returns a single four-byte word representing the revision number of the device. Software should not depend upon this value because it may change from time to time.

**Table 8-13. Input Parameters**

	Name	Size	Notes
Opcode	DEVREV	1	0x30.
Param1	Mode	1	Must be zero.
Param2	—	2	Must be zero.
Data	—	0	—

**Table 8-14. Output Parameters**

Name	Size	Notes
Success	4	The current device revision number.

## 8.5.8 GenDig Command

The `GenDig` command uses SHA-256 to combine a stored value with the contents of `TempKey`, which must have been valid prior to the execution of this command. The stored value can come from one of the data slots, either of the OTP pages, either of the first two pages of the Configuration zone, or retrieved from the hardware transport key array. The resulting digest is retained in `TempKey`, and can be used in one of three ways as follows:

1. It can be included as part of the message used by the `MAC`, `CheckMac`, or `HMAC` commands. Because the `MAC` response output incorporates both the data used in the `GenDig` calculation and the secret key from the `MAC` command, it serves to authenticate the data stored in the Data and/or OTP zones.
2. A subsequent `Read` or `Write` command can use the digest to provide authentication and/or confidentiality for the data, in which case it is known as a data protection digest.
3. This command can be used for secure personalization by using a value from the transport key array. The resulting data protection digest would then be used by the `Write` Command.

If zone is two (Data) and `SlotID` is less than or equal to 15, the `GenDig` command sets `TempKey.GenData` to one and `TempKey.SlotID` to the input `SlotID`; otherwise, `TempKey.GenData` is set to zero.

Regardless of how the resulting digest is computed, it can never be read from the device.

If `TempKey.Valid` is invalid, this command returns an error. Upon command completion, the `TempKey.Valid` bit is set, indicating that a digest has been loaded and is ready for use. The `TempKey.Valid` bit is cleared when the next command is executed. See [Section 2.2, “Static RAM \(SRAM\)”](#) for details.

For all `SlotID` values less than `0x8000`, the device uses the least-significant four bits of `SlotID` to determine the slot number from which to retrieve the key value from the Data zone of the EEPROM. `SlotID` values above `0x8000` reference keys stored in the masks of the design. In any event, all 16 bits of `SlotID` as input to the device are used as `Param2` in the SHA-256 calculation.

If the zone parameter points to the Configuration zone, then this command returns an error if the Configuration zone is unlocked.

When the key specified on input to `GenDig` has the `CheckOnly` bit set, `GenDig` can be used to generate ephemeral keys matching those generated on Client `CryptoAuthentication` devices using the `DeriveKey` command. Keys that have the `CheckOnly` bit set represent situations in which the device is acting as a Host. In this case, the opcode and parameter bytes that would normally be included in the SHA calculation are replaced with bytes from the input stream.

**Table 8-15. Input Parameters**

	Name	Size	Notes
Opcode	GENDIG	1	0x15
Param1	Zone	1	If 0x00 (Config), then use <code>SlotID</code> to specify either the first ( <code>SlotID=0</code> ) or second ( <code>SlotID = 1</code> ) 256-bit block of the Configuration zone. If 0x01 (OTP), then use <code>SlotID</code> to specify either the first or second 256-bit block of the OTP zone. If 0x02 (Data), then <code>SlotID</code> specifies a slot in the Data zone or a transport key in the hardware array. All other values are reserved and must not be used.
Param2	SlotID	2	Identification number of the key to be used, or selection of which OTP block.
Data	OtherData	4 or 0	Four bytes of data for SHA calculation when using a <code>CheckOnly</code> key; otherwise ignored.

**Table 8-16. Output Parameter**

Name	Size	Notes
Success	1	Upon successful execution, the ATSHA204A returns a value of zero.

If zone is Data and SlotConfig[SlotID].CheckOnly is one, the SHA-256 message body used to create the resulting new TempKey consists of the following bytes:

32 bytes	Data.slot[SlotID]
4 bytes	OtherData
1 byte	SN[8]
2 bytes	SN[0:1]
25 bytes	Zeros
32 bytes	TempKey.value

In all other cases, the message use to create TempKey is as follows:

32 bytes	Config[SlotID] or OTP[SlotID] or Data.slot[SlotID] or TransportKey[SlotID]
1 byte	Opcode
1 byte	Param1
2 bytes	Param2
1 byte	SN[8]
2 bytes	SN[0:1]
25 bytes	Zeros
32 bytes	TempKey.value

## 8.5.9 HMAC Command

The HMAC command computes an HMAC/SHA-256 digest of a key stored in the device, a challenge, and other information on the device. The output of this command is the output of the HMAC algorithm computed over this key and message. If the message includes the serial number of the device, the response is said to be “diversified”.

The normal command flow to use this command is as follows:

1. Run the `Nonce` command to load input challenge and optionally combine it with a generated random number. The result of this operation is a nonce stored internally on the device.
2. Optionally run `GenDig` command to combine one or more stored EEPROM locations in the device with the nonce. The result is stored internally in the device.
3. Run this `HMAC` command to combine the output of step one (and Step 2 if desired) with an EEPROM key to generate an output response.

Step 2 addresses multiple use models. If the data in the EEPROM is a key, `GenDig` has the effect of authenticating the challenge with multiple secret keys. Alternatively, if the contents of the slot are data (which do not have to necessarily even be secret), `GenDig` has the effect of authenticating the value stored in that location.

**Table 8-17. Input parameters**

	Name	Size	Notes
Opcode	HMAC	1	0x11.
Param1	Mode	1	Controls which fields within the device are used in the message.
Param2	SlotID	2	Which key is to be used to generate the response. Bits 0:3 only are used to select a slot but all 16 bits are used in the HMAC message.
Data	—	0	—

**Table 8-18. Output parameter**

Name	Size	Notes
Response	32	HMAC digest

The HMAC digest is computed using the key at SlotID as the HMAC key over a message consisting of the following information:

32 bytes	Zeros
32 bytes	TempKey
1 byte	Opcode (always 0x11.)
1 byte	Mode
2 bytes	SlotID
8 bytes	OTP[0:7] or zeros (see <a href="#">Table 8-19.</a> )
3 bytes	OTP[8:10] or zeros (see <a href="#">Table 8-19.</a> )
1 byte	SN[8]
4 bytes	SN[4:7] or zeros (see <a href="#">Table 8-19.</a> )
2 bytes	SN[0:1]
2 bytes	SN[2:3] or zeros (see <a href="#">Table 8-19.</a> )

See [Section 13.2, “HMAC/SHA-256”](#) for the governing documents which contain a complete description of how the various digests are calculated using SHA-256, the HMAC key, and appropriate padding.

**Table 8-19. Mode Encoding**

Bits	Meaning
7	Must be zero.
6	If set, include the 48 bits SN[2:3] and SN[4:7] in the message.; otherwise, the corresponding message bits are set to zero.
5	Include the first 64 OTP bits (OTP[0] through OTP[7]) in the message.; otherwise, the corresponding message bits are set to zero. If Mode[4] is set, the value of this mode bit is ignored.
4	Include the first 88 OTP bits (OTP[0] through OTP[10]) in the message.; otherwise, the corresponding message bits are set to zero.
3	Must be zero.
2	The value of this bit must match the value in TempKey.SourceFlag or the command will return an error.
0 – 1	Must be zero.

### 8.5.10 Lock Command

Write either LockConfig or LockData to 0x00, to change the permissions in the designated zone.

This command fails if the designated zone is already locked.

Prior to locking the device, the ATSHA204A uses the CRC-16 algorithm to generate a summary digest of the designated zone(s). The calculation is made identically to the CRC computed over the input and output blocks.

- For the Configuration zone, the CRC is calculated over all 88 bytes.
- For the Data and OTP zones, their contents are concatenated in that order to create the input to the CRC algorithm.

If the input summary does not match that computed on the device, an error is returned and the personalization process should be repeated.

**Table 8-20. Input Parameters**

Name	Size	Notes	
Opcode	LOCK	1	0x17.
Param1	Zone	1	Bit 0: Zero for Configuration zone, one for Data and OTP zones. Bits 1-6: Must be zero. Bit 7: If one, the check of the zone CRC is ignored and the zone is locked, regardless of the state of the memory. Atmel does <i>not</i> recommend using this mode.
Param2	Summary	2	Summary of the designated zones, or should be 0x0000 if Zone[7] is set.
Data	—	0	—

**Table 8-21. Output Parameter**

Name	Size	Notes
Success	1	Upon successful execution, the ATSHA204A returns a value of zero.

## 8.5.11 MAC Command

The MAC command computes a SHA-256 digest of a key stored in the device, a challenge, and other information on the device. The output of this command is the digest of this message. If the message includes the serial number of the device, the response is said to be “diversified”.

The normal command flow to use this command is as follows:

1. Run the `Nonce` command to load input challenge and optionally combine it with a generated random number. The result of this operation is a nonce stored internally on the device within tempkey.
2. Optionally run the `GenDig` command to combine one or more stored EEPROM locations in the device with the nonce. The result is stored internally in the device within tempkey. This capability permits two or more keys to be used as part of the response generation.
3. Run this MAC command to combine the output of [Step 1.](#) (and [Step 2.](#) if desired) with an EEPROM key to generate an output response (or digest).

**Table 8-22. Input Parameters**

	Name	Size	Notes
Opcode	MAC	1	0x08.
Param1	Mode	1	Controls which fields within the device are used in the message.
Param2	SlotID	2	Which internal key is to be used to generate the response. Bits 0:3 only are used to select a slot but all 16 bits are used in the SHA-256 message.
Data	Challenge	0 or 32	Input portion of message to be digested, ignored if Mode:0 is one.

**Table 8-23. Output Parameter**

Name	Size	Notes
Response	32	SHA-256 digest.

The message that will be hashed with the SHA-256 algorithm consists of the following information:

32 bytes	key[SlotID] or TempKey (See <a href="#">Table 8-24.</a> )
32 bytes	Challenge or TempKey (See <a href="#">Table 8-24.</a> )
1 byte	Opcode (Always 0x08.)
1 byte	Mode
2 bytes	Param2
8 bytes	OTP[0:7] or zeros (See <a href="#">Table 8-24.</a> )
3 bytes	OTP[8:10] or zeros (See <a href="#">Table 8-24.</a> )
1 byte	SN[8]
4 bytes	SN[4:7] or zeros (See <a href="#">Table 8-24.</a> )
2 bytes	SN[0:1]
2 bytes	SN[2:3] or zeros (See <a href="#">Table 8-24.</a> )

**Table 8-24. Mode Encoding**

Bits	Meaning
7	Must be zero.
6	If set, include the 48 bits SN[2:3] and SN[4:7] in the message; otherwise, the corresponding message bits are set to zero.
5	Include the first 64 OTP bits (OTP[0] through OTP[7]) in the message; otherwise, the corresponding message bits are set to zero. If Mode[4] is set, the value of this mode bit is ignored.
4	Include the first 88 OTP bits (OTP[0] through OTP[10]) in the message; otherwise, the corresponding message bits are set to zero.
3	Must be zero.
2	If either Mode:0 or Mode:1 are set, Mode:2 must match the value in TempKey.SourceFlag or the command will return an error.
1	If zero, then the first 32 bytes of the SHA message are loaded from one of the data slots. If one, then the first 32 bytes are filled with TempKey.
0	If zero, then the second 32 bytes of the SHA message are taken from the input Challenge parameter. If one, then the second 32 bytes are filled with the value in TempKey. This mode is recommended for all use.



## 8.5.12 Nonce Command

The `Nonce` command generates a nonce for use by a subsequent `GenDig`, `MAC`, `HMAC`, `Read`, or `Write` command by combining an internally generated random number with an input value from the system. The resulting nonce is stored internally in `TempKey` and the generated random number is returned to the system.

The input value is designed to prevent replay attacks against the Host, and it must be externally generated by the system and passed into the device using this command. It may be any value that changes consistently, such as a nonvolatile counter, current real time of day, and so forth; or it can be an externally generated random number.

To provide a nonce value for subsequent crypto commands, the input number and output random number are hashed together according to the information listed below. The resulting digest (nonce) is always stored in the `TempKey` register, `TempKey.Valid` is set, and `TempKey.SourceFlag` is set to "Rand". The nonce can be used by a subsequent `GenDig`, `Read`, `Write`, `HMAC`, or `MAC` command, thus the system must externally compute this digest value and store it externally to complete the execution of those commands.

Alternatively, this command can also be run in a pass-through mode if a fixed nonce is required for subsequent commands. In this case, the input value must be 32 bytes long, and it is passed directly to `TempKey` without modification. No SHA-256 calculation is performed, and `TempKey.SourceFlag` is set to "Input." The nonce value in `TempKey` may not be used with `Read` or `Write` commands. If operated in this mode and with a repeated input number value, the device provides no protection against replay attacks.

Prior to the configuration section being locked, the RNG produces a value of `0xFF FF 00 00 FF FF 00 00` to facilitate testing. This test value is combined with the input value in the manner described above.

**Table 8-25. Input Parameters**

	Name	Size	Notes
Opcode	Nonce	1	0x16.
Param1	Mode	1	Controls the mechanism of the internal RNG and seed update.
Param2	Zero	2	Must be 0x0000.
Data	NumIn	20,32	Input value from system.

**Table 8-26. Output Parameter**

Name	Size	Notes
RandOut	1 or 32	The output of the RNG or a single byte with a value of zero if <code>Mode[0:1]</code> is three.

If `Mode[0:1]` is zero or one, the input `NumIn` parameter must be 20 bytes long, and the SHA-256 message body used to create the nonce stored internally in `TempKey` consists of the following:

32 bytes	RandOut
20 bytes	NumIn from input stream
1 byte	Opcode (Always 0x16.)
1 byte	Mode
1 byte	LSB of Param2 (Should always be 0x00.)

Upon completion of the command, `TempKey.SourceFlag` is set to "Rand."

If Mode[0:1] is three, this command operates in pass-through mode, the input parameter (NumIn) must be 32 bytes long, and TempKey is loaded with NumIn. No SHA-256 calculation is performed, no data is returned to the system, and TempKey.SourceFlag is set to “Input.”

If Mode[0:1] is one, the automatic seed update is suppressed. See [Section 3.2, “Random Number Generator \(RNG\)”](#) for more details. Atmel recommends that this bit be set to zero for highest security.

**Table 8-27. Mode Encoding**

Bits	Meaning
2 – 7	Must be zero.
0 – 1	<p>If zero, then combine the new random number with NumIn, store in TempKey. Automatically update EEPROM seed only if necessary prior to random number generation. Recommended for highest security.</p> <p>If one, then combine the new random number with NumIn, store in TempKey. Generate random number using existing EEPROM seed, do <i>not</i> update EEPROM seed.</p> <p>If two, then is it invalid.</p> <p>If three, then operate in the pass-through mode and write TempKey with NumIn.</p>

### 8.5.13 Pause Command

All devices on the bus for which the configuration Selector byte does *not* match the input selector parameter will go into the idle state. This command is used to prevent bus conflicts in a system that includes multiple ATSHA204A devices sharing the same bus.

The **Pause** command differs from the idle flag/sequence in that individual devices on the single pin bus may be selected to go into the idle state, as opposed to the idle flag which causes all the CryptoAuthentication devices on the bus into the idle state.

If the EEPROM Selector byte does *not* match the input selector parameter, the device will immediately go to the idle state and no result information will be available. If the input selector parameter does match the configuration selector byte, the device returns a success code of 0x00.

The **Pause** command cannot be used to put the devices into the sleep state.

**Table 8-28. Input Parameters**

	Name	Size	Notes
Opcode	PAUSE	1	0x01.
Param1	Selector	1	All devices that do not match this value go to idle state.
Param2	Zero	2	Must be 0x0000.
Data	—	0	—

**Table 8-29. Output Parameter**

Name	Size	Notes
Success	1	If the command indicates that some other device should idle, the ATSHA204A returns a value of 0x00. If this device goes to idle, no value is returned.

## 8.5.14 Random Command

The `Random` command generates a random number for use by the system.

Random numbers are generated through a combination of the output of a hardware RNG and an internal seed value stored in the EEPROM or SRAM. The external system may choose to update the internally stored EEPROM seed value prior to the generation of the random number as part of the execution of the nonce or random command, for highest security, Atmel recommends that the EEPROM seed always be updated.

The random command does not provide a mechanism to integrate an input number with the internal stored seed. If this functionality is desired, the system should use the Nonce command and ignore the generated nonce.

Prior to the configuration section being locked, the RNG produces a value of `0xFF, 0xFF, 0x00, 0x00, 0xFF, 0xFF, 0x00, 0x00` to facilitate testing.

**Note:** The same internally stored seeds are used for both the Nonce and Random commands. Use of `Mode=0` ensures that the EEPROM is updated, if necessary.

**Table 8-30. Input Parameters**

	Name	Size	Notes
Opcode	RANDOM	1	0x1B.
Param1	Mode	1	Controls the mechanism of the internal RNG and seed update.
Param2	Zero	2	Must be <code>0x0000</code> .
Data	—	0	—

**Table 8-31. Output Parameter**

Name	Size	Notes
RandOut	32	The output of the RNG.

**Table 8-32. Mode Encoding**

Bits	Meaning
1 – 7	Must be zero.
0	If zero, then it will automatically update EEPROM seed only if necessary prior to random number generation. Recommended for highest security. If one, then it will generate a random number using existing EEPROM seed; do <i>not</i> update EEPROM seed.

## 8.5.15 Read Command

The `Read` command reads words (one 4-byte word or an 8-word block of 32 bytes) from one of the memory zones of the device. The data may optionally be encrypted before being returned to the system. See [Section 2.1.1, “Data Zone”](#) for Data zone byte and word addressing information.

If reading from a slot in which `SlotConfig.EncryptRead` is set, the `GenDig` command must have been run prior to the execution of this command to generate the key that will be used for encryption. If the slot number is even, or if the `CheckMacSource` bit corresponding to this slot is zero, then the input nonce to `GenDig` must have been a random number. Finally, the key specified in `SlotConfig.ReadKey` must have been used in the `GenDig` calculation.

The device encrypts data to be read by XORing each byte read from the EEPROM with the corresponding byte from `TempKey`. Encrypted reads of the Configuration and/or OTP zones are not permitted.

The byte addresses to be read should be divided by four (drop the least-significant two bits) before being passed to the device. If 32 bytes are being read, the least-significant three bits of the input address are ignored. Addresses beyond the end of the specified zone result in an error.

The following restrictions apply to the following three zones:

- **Data**  
If the Data zone is unlocked, this command returns an error; otherwise, the values within the corresponding `SlotConfig` word act to control access to the data slot. If `SlotConfig.IsSecret` is set and a four byte read is attempted, the device returns an error. If `EncryptRead` is set, this command encrypts the data as specified above. If `IsSecret` is set and `EncryptRead` is clear, then this command returns an error. If `IsSecret` is clear and `EncryptRead` is clear, then this command returns the desired slot in the clear.
- **Configuration**  
The words within this zone are always readable using this command, regardless of the value of `LockConfig`.
- **OTP**  
If the OTP zone is unlocked, then this command returns an error. Once locked, if OTP mode is not set to legacy, then all words can be read. If OTP mode is legacy, then only four byte reads are permitted, and addresses of a zero or one will return an error.

**Table 8-33. Input Parameters**

	Name	Size	Notes
Opcode	READ	1	0x02
Param1	Zone	1	Bits 0 and 1: Select among config, OTP, or data. See <a href="#">Section 8.5.3, “Zone Encoding”</a> . Bits 2-6: Must be zero. Bit 7: If one, 32 bytes are read; otherwise four bytes are read. Must be zero if reading from OTP zone.
Param2	Address	2	Address of first word to be read within the zone. See <a href="#">Section 8.5.4, “Address Encoding”</a> .
Data	—	0	—

**Table 8-34. Output Parameter**

Name	Size	Notes
Contents	4 or 32	The contents of the specified memory location.

### 8.5.15.1 Read Operations within the Data Zone

Read operations within the Data zone depend upon the state of IsSecret and EncryptRead according to the following table:

**Table 8-35. Read Operation Permission**

IsSecret	EncryptRead	Description
0	0	Clear text reads are always permitted from this slot. Slots set to this state should never be used as key storage. Either 4 or 32 bytes may be read at a time.
0	1	Prohibited. No security is guaranteed for slots using this code.
1	0	Reads are never permitted from this slot. Slots set to this state can still be used for key storage.
1	1	Reads from this slot are encrypted using the encryption algorithm documented in the Read command description (See <a href="#">Section 8.5.15, "Read Command"</a> ). The encryption key is in the slot specified by ReadKey. 4-byte reads and writes are prohibited.

If reading the Data zone and the EncryptRead bit is set in the corresponding SlotConfig word, then the following actions are taken to encrypt the data:

- All of the TempKey register bits must be properly set as follows, or this command returns an error:  
TempKey.Valid == 1  
TempKey.GenData == 1  
TempKey.SlotID == SlotConfig.ReadKey
- If the slot number being read is even, then TempKey.SourceFlag must be "RAND".
- If the slot number is odd, then TempKey.SourceFlag must match the value in Config.CheckMacSource corresponding to the slot.
- XOR the data from the memory zone with TempKey. Return as "Contents."

## 8.5.16 SHA Command

The `SHA` command computes a SHA-256 digest for general purpose use by the system. Any message length can be accommodated. The system is responsible for sending the pad and length bytes with the last block.

Calculation of a digest occurs via the following two steps:

1. Initialization  
Setup the SHA-256 calculation engine by overwriting the current value of `TempKey` with the initialization constant. Force the `TempKey` flags to match the state they would have after a `Nonce(Fixed)` command. This mode does not accept any message bytes.
2. Compute  
The command can be called a variable number of times with this mode to add bytes to the message. Each iteration of this mode must include a message of 64 bytes. The output buffer always contains the digest, which can be ignored if desired. The digest is also loaded into `TempKey`.

The `SHA(Init)` command must be run before any `SHA(Compute)` commands will be accepted. The system may run as many `SHA(Compute)` commands as required to compute the desired digest. An error is returned if any command other than `SHA` is run between the “Init” iteration and the last “Compute” iteration. The command also returns a Parse error if the Mode byte has a value other than zero or one.

The intermediate digest stored in `TempKey` will be invalidated if the device is put to sleep or the watchdog timer expires. The system software must ensure that either the entire message is sent to the device during a single wake/watchdog interval or that the appropriate Idle sequences are inserted between the `SHA` commands.

**Table 8-36. Input Parameters**

	Name	Size	Notes
Opcode	SHA	1	0x47
Param1	Mode	1	Bit 0 = 0 (Init): Load <code>TempKey</code> with the initialization value for SHA-256. No message bytes are accepted (Length must be zero). Bit 0 = 1 (Compute): Add 64 bytes in the message parameter to the SHA context and return the digest Bits 1-7: Must be zero.
Param2	Param2	2	Must be zero.
Data	Message	0 or 64	64 bytes of data to be included into the hash operation. Ignored if Mode is zero.

**Table 8-37. Output Parameter**

Name	Size	Notes
Response	1 or 32	The SHA-256 digest if Mode = 1; otherwise, zero for success or an error code.

### 8.5.17 UpdateExtra Command

The UpdateExtra command is used to update the values of the two extra bytes within the Configuration zone (location 84 and 85) after the Configuration zone has been locked. It can also be used to quickly decrement the usage counters attached to a key when appropriate.

If Mode:1 is set, then the command implements a fast decrement of the limited use counters that may be associated with a particular key. If the slot indicated by the “NewValue” parameter does not contain a key for which limited use is implemented or enabled, then the command returns silently without taking any action. If the indicated slot contains a limited use key which does not have any uses remaining, then the command returns an error; otherwise, one of the remaining usage bits is cleared. The command does not modify Config.UpdateCount for the slot in question.

If the mode parameter indicates UserExtra at address 84:

- If the current value in UserExtra (byte 84 of Configuration zone) is zero, then UpdateExtra writes this byte with the LS byte of NewValue and returns success.
- If the current value in UserExtra is non-zero, then the command returns an execution error.

If the mode parameter indicates selector at address 85:

- If SelectorMode (byte 19 of the Configuration zone) is non-zero and Selector (byte 85 of the Configuration zone) is zero, then this command will write Selector with the LS byte of NewValue and return success. Once written to a non-zero value, it is then locked against further updating.
- If SelectorMode has a value of zero, indicating that no check of the current Selector should be made, then this command always updates Selector and always succeeds.

**Table 8-38. Input Parameters**

	Name	Size	Notes
Opcode	UPDTEEXTRA	1	0x20.
Param1	Mode	1	Bit 0: If zero, update Config byte 84. If one, update Config byte 85. Bit 1: If one, ignore bit 0 and decrement the limited use counter associated with the key in slot “NewValue”. If zero, update Config byte 84 or 85. Bits 2 – 7: Must be zero.
Param2	NewValue	2	LSB: Value to optionally be written to location 84 or 85 in Configuration zone. MSB: Must be 0x00.
Data	—	0	—

**Table 8-39. Output Parameter**

Name	Size	Notes
Success	1	If the memory byte was updated, this command returns a value of 0x00; otherwise, it returns an Execution error.



## 8.5.18 Write Command

The `Write` command writes either a one 4-byte word or an 8-word block of 32 bytes to one of the EEPROM zones upon the device. Depending on the value of the `WriteConfig` byte for this slot the data may be required to be encrypted by the system prior to being sent to the device.

The following restrictions apply to writes within zones using this command:

- **Data**  
If the Configuration zone is locked and the Data zone is unlocked, then all bytes in all zones can be written with either plain text or encrypted data using 32 byte writes. After the Data zone is locked, the values within the `WriteConfig` bytes control access to the data slots. If the `WriteConfig` bits for this slot are set to “always”, then the input data should be passed to the device in the clear. If Bit:14 of `SlotConfig` is set to one, the input data should be encrypted and an input MAC calculated.
- **Configuration**  
If the Configuration zone is locked or `Zone:6` is set, then this command returns an error; otherwise the bytes are written as requested. Any attempt to write any byte for which Writes are permanently prohibited (per [Section 2.1.1, “Data Zone”](#)) results in a command error with no modifications to the EEPROM.
- **OTP**  
If the OTP zone is unlocked, then all bytes can be written with this command. If the OTP zone is locked and the `OTPmode` byte is read-only or legacy, then this command returns an error; otherwise, OTP mode should be consumption and this command sets to zero those bits in the OTP zone that correspond to the zero bits in the input parameter value. When the OTP zone is locked, encrypted writes to it are never permitted regardless of `OTPmode`.

Four byte writes are only permitted in the Data and OTP zones if all four of the following conditions are met:

- `SlotConfig.IsSecret` must be zero.
- `SlotConfig.WriteConfig` must be “always.”
- The input data must not be encrypted.
- The Data/OTP zones must be locked.

Four byte writes will return an error under all other circumstances.

The least significant three bits of `Param2`, `Address[0:2]`, indicate the word within the block, or are ignored if an entire 32 byte block is being written. `Address[3:6]` contains the slot number for writes to the Data zone, or the block number for the Configuration and OTP zones. Address values beyond the size of the specified zone result in the command returning an error.

Any attempt to write the OTP and/or Data zones prior to the configuration section being locked results in the device returning an error code.

### 8.5.18.1 Input Data Encryption

The input data may be encrypted to prevent snooping on the bus during personalization or system operation. The system should encrypt the data by XORing the plain text with the current value in `TempKey`. Upon receipt, the device will XOR the input data with `TempKey` to restore the plain text prior to writing to the EEPROM.

Whenever the input data is encrypted an authorizing input MAC is always required when writing the Data zone. This MAC is computed as follows:

SHA-256(`TempKey`, `Opcode`, `Param1`, `Param2`, `SN[8]`, `SN[0:1]`, <25 bytes of 0's>, `PlainTextData`)

Prior to locking of the OTP/Data zones, `Zone:6` is used to indicate to the device whether or not the input data is encrypted. After locking of the OTP/Data zones, `Zone:6` is ignored and only bit 14 of the `slotConfig` corresponding to the slot being written is used to determine whether or not the input data is encrypted.

If data encryption is indicated, then TempKey must be valid prior to this command being called, and it must be the result of GenDig. Specifically, this means that TempKey.Valid and TempKey.GenDig must both be set to one. Prior to data locking, any key can be used to generate TempKey. After locking, the last slot used by GenDig for TempKey creation and stored in TempKey.SlotID must match that in SlotConfig.WriteKey. If the slot number being written is even, then TempKey.SourceFlag must be RAND. If the slot number is odd, then TempKey.SourceFlag must match the value in Config.CheckMacSource corresponding to the slot.

**Table 8-40. Input Parameters**

	Name	Size	Notes
Opcode	Write	1	0x12
Param1	Zone	1	Bits 0 and 1: Select among config, OTP or data. See <a href="#">Section 8.5.3, “Zone Encoding”</a> . Bits 2-5: Must be zero. Bit 6: If one, the input data must be encrypted. Must be zero if Data/OTP zones are locked. Bit 7: If one, 32 bytes will be written; otherwise, four bytes are written.
Param2	Address	2	Address of first word to be written within the zone. See <a href="#">Section 8.5.4, “Address Encoding”</a> .
Data_1	Value	4 or 32	Information to be written to the zone; may be encrypted.
Data_2	Mac	0 or 32	Message authentication code to validate address and data. Ignored if zone is unlocked.

**Table 8-41. Output Parameter**

Name	Size	Notes
Success	1	Upon successful completion, the ATSHA204A returns a value of zero.

## 9. Compatibility

The ATSHA204A is designed to be fully compatible with the ATSHA204 for all Host, Client, and personalization operations. Please note the following important refinements that have been made to the ATSHA204A:

- Active power consumption is lower.
- Two-wire connection mode is supported without the requirement for an external diode.
- The new `SHA` command permits general computation of a SHA digest without the need for crypto software in the Host.
- Write operations during personalization always require a MAC to be passed to the device to prevent man-in-the middle attacks. (Some versions of the ATSHA204 ignored the MAC on Write when the Data zone was unlocked.)
- The `UpdateExtra` command can now be used to quickly decrement the limited-use counters when a multi-step count is required.
- The Copy mode of the `CheckMac` command can now be run with a fixed nonce which simplifies the implementation of protected secure boot validation and other related tasks.
- The new Consumption mode on the OTP zone provides additional capability for usage tracking.
- Write operations to the OTP or Data zone require 32 bytes when the Configuration zone is locked and the OTP and Data zones are unlocked. The ATSHA204 allowed 4 byte Write commands for this lock state.

## 10. Mechanical

### 10.1 Pinout

The device is offered in multiple packages:

- 8-pad UDFN
- 3-lead SOT23
- 8-lead SOIC
- 8-pad XDFN
- 8-lead TSSOP<sup>(1)</sup>
- 3-lead CONTACT intended for mechanical, not soldered, connection.

The pinouts are as follows:

**Table 10-1. Package Pinouts**

Name	3-lead SOT23	8-lead SOIC, 8-lead TSSOP <sup>(1)</sup> , 8-pad UDFN, and 8-pad XDFN	3-lead CONTACT
SDA	1	5	1
SCL	—	6	—
V <sub>CC</sub>	2	8	3
GND	3	4	2
NC	—	1, 2, 3, 7	—

Note: 1. Not recommended for new designs.

# 11. Package Drawings

## 11.1 8-lead SOIC

**TOP VIEW**

**END VIEW**

**SIDE VIEW**

**COMMON DIMENSIONS**  
(Unit of Measure = mm)

SYMBOL	MIN	NOM	MAX	NOTE
A	–	–	1.75	
A1	0.10	–	0.25	
b	0.31	–	0.51	
C	0.17	–	0.25	
D	4.90 BSC			
E	6.00 BSC			
E1	3.90 BSC			
e	1.27 BSC			
L	0.40	–	1.27	
∅	0°	–	8°	

Notes: This drawing is for general information only.  
Refer to JEDEC Drawing MS-012, Variation AA  
for proper dimensions, tolerances, datums, etc.

3/6/2015

 Package Drawing Contact: packagedrawings@atmel.com	<b>TITLE</b> 8S1, 8-lead (0.150" Wide Body), Plastic Gull Wing Small Outline (JEDEC SOIC)	<b>GPC</b> SWB	<b>DRAWING NO.</b> 8S1	<b>REV.</b> H
---	---	-------------------	---------------------------	------------------

## 11.2 8-lead TSSOP

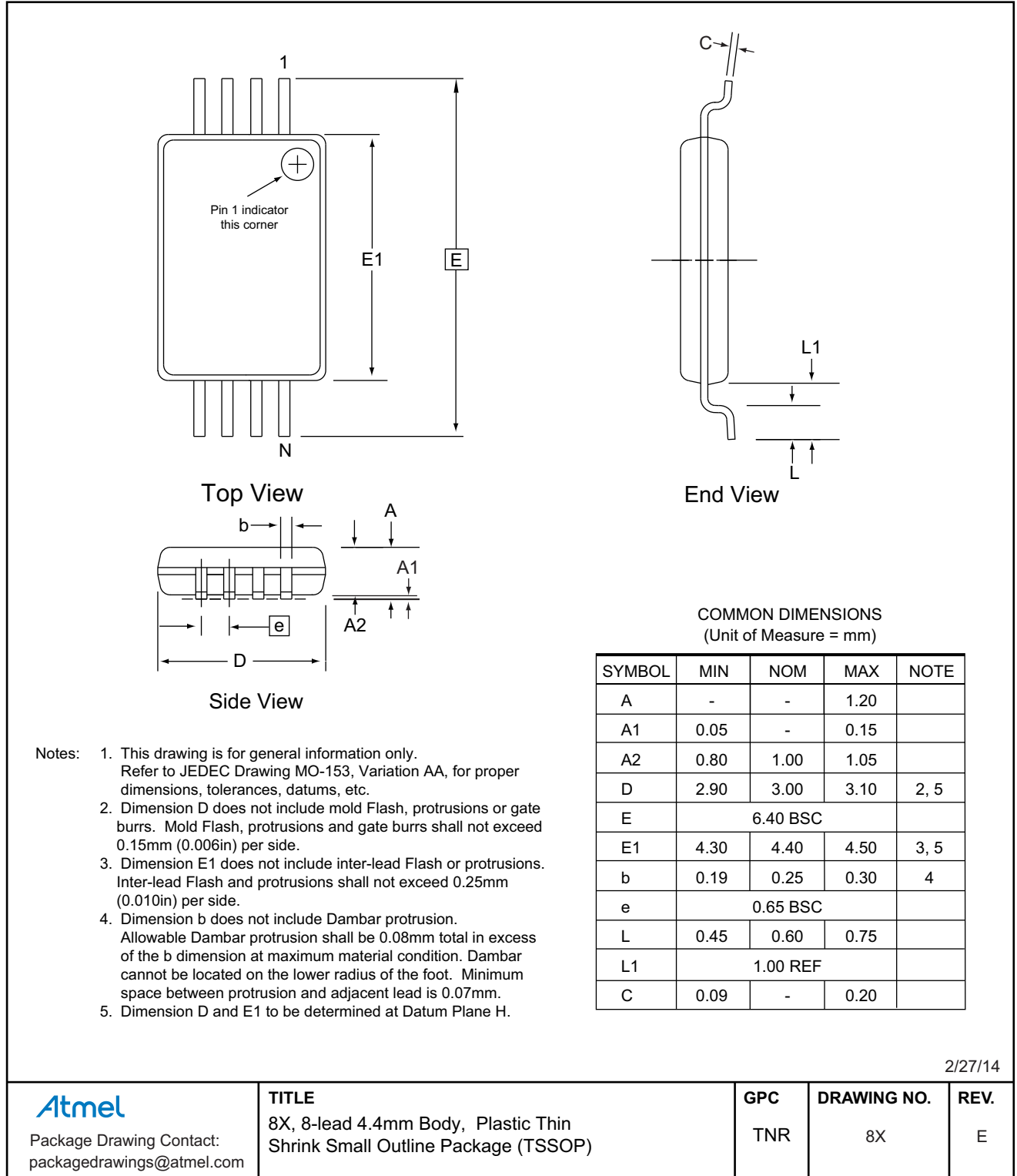

### 11.3 3-lead SOT23

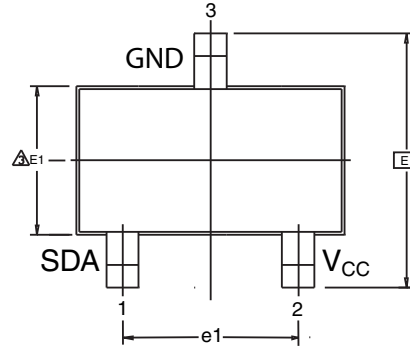

Top View

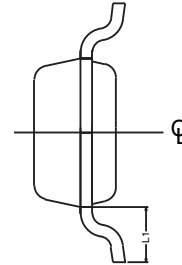

End View

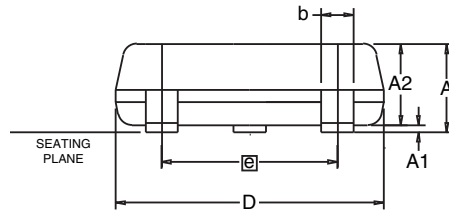

Side View

- Notes:
1. Dimension D does not include mold flash, protrusions or gate burrs. Mold flash, protrusions or gate burrs shall not exceed 0.25mm per end. Dimension E1 does not include interlead flash or protrusion. Interlead flash or protrusion shall not exceed 0.25mm per side.
  2. The package top may be smaller than the package bottom. Dimensions D and E1 are determined at the outermost extremes of the plastic body exclusive of mold flash, tie bar burrs, gate burrs and interlead flash, but including any mismatch between the top and bottom of the plastic body.
  3. These dimensions apply to the flat section of the lead between 0.08 mm and 0.15mm from the lead tip.

This drawing is for general information only. Refer to JEDEC Drawing TO-236, Variation AB for additional information.

**COMMON DIMENSIONS**  
(Unit of Measure = mm)

SYMBOL	MIN	NOM	MAX	NOTE
A	0.89	-	1.12	
A1	0.01	-	0.10	
A2	0.88	-	1.02	
D	2.80	2.90	3.04	1,2
E	2.10	-	2.64	
E1	1.20	1.30	1.40	1,2
L1	0.54 REF			
e1	1.90 BSC			
b	0.30	-	0.50	3

12/11/09

**Atmel**

Package Drawing Contact:  
packagedrawings@atmel.com

**TITLE**  
**3TS1, 3-lead, 1.30mm Body, Plastic Thin**  
Shrink Small Outline Package (Shrink SOT)

**GPC**  
TBG

**DRAWING NO.**  
3TS1

**REV.**  
B

## 11.4 8-pad UDFN

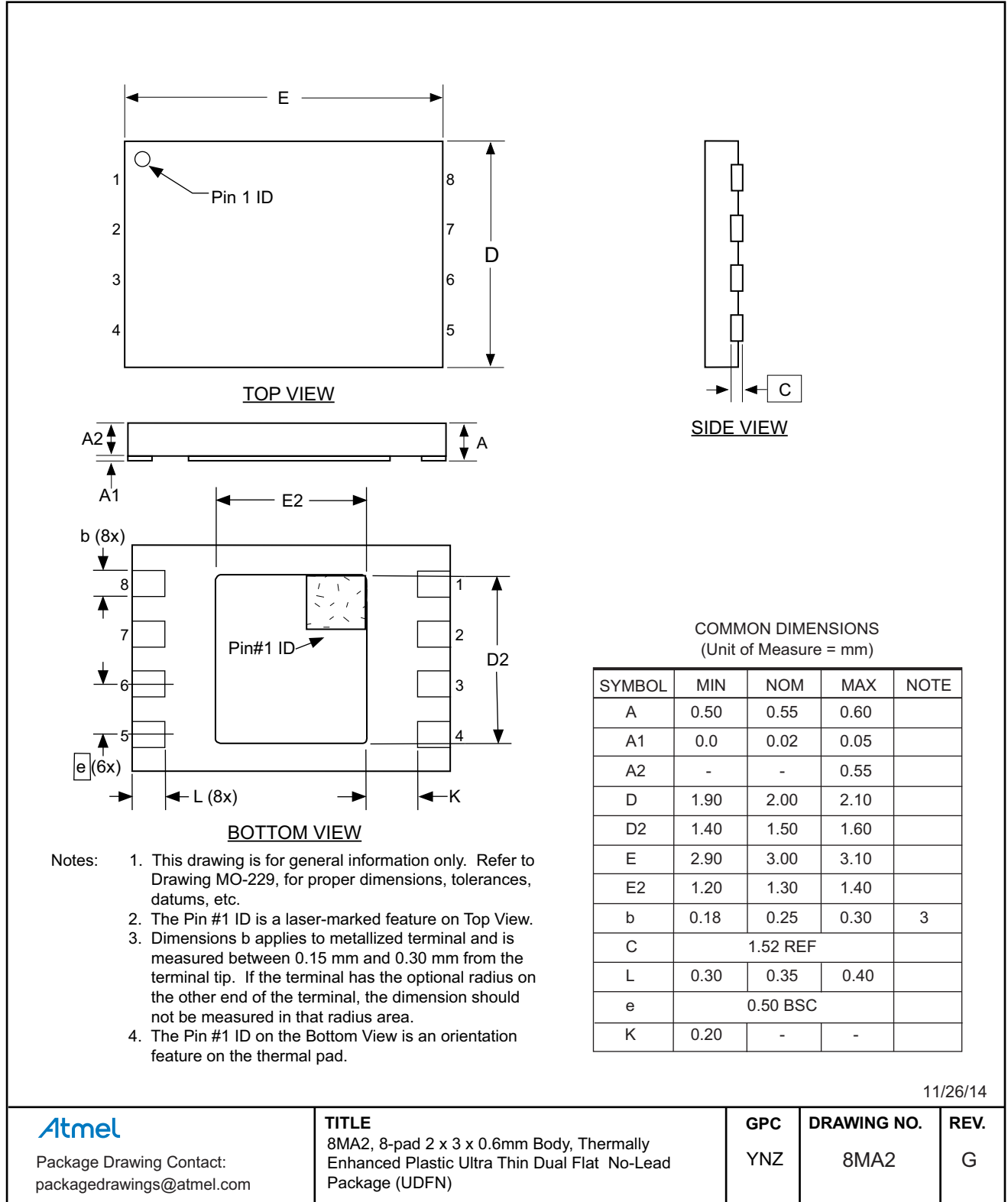

11/26/14

**Atmel**

Package Drawing Contact:  
packagedrawings@atmel.com

**TITLE**

8MA2, 8-pad 2 x 3 x 0.6mm Body, Thermally Enhanced Plastic Ultra Thin Dual Flat No-Lead Package (UDFN)

**GPC**

YNZ

**DRAWING NO.**

8MA2

**REV.**

G



## 11.5 8-pad XDFN

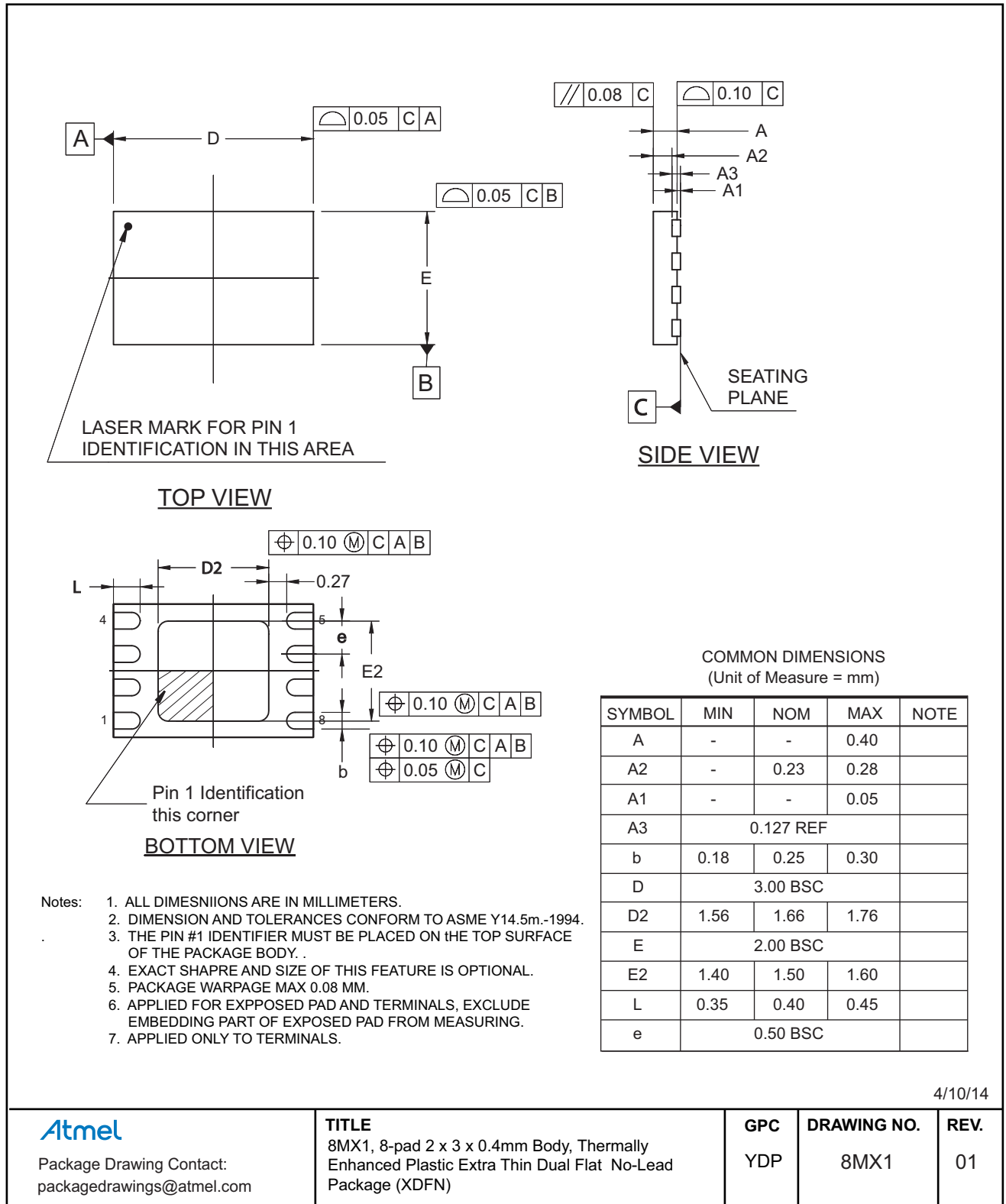

4/10/14

**Atmel**

Package Drawing Contact:  
packagedrawings@atmel.com

**TITLE**

8MX1, 8-pad 2 x 3 x 0.4mm Body, Thermally Enhanced Plastic Extra Thin Dual Flat No-Lead Package (XDFN)

**GPC**

YDP

**DRAWING NO.**

8MX1

**REV.**

01

## 11.6 3-lead CONTACT

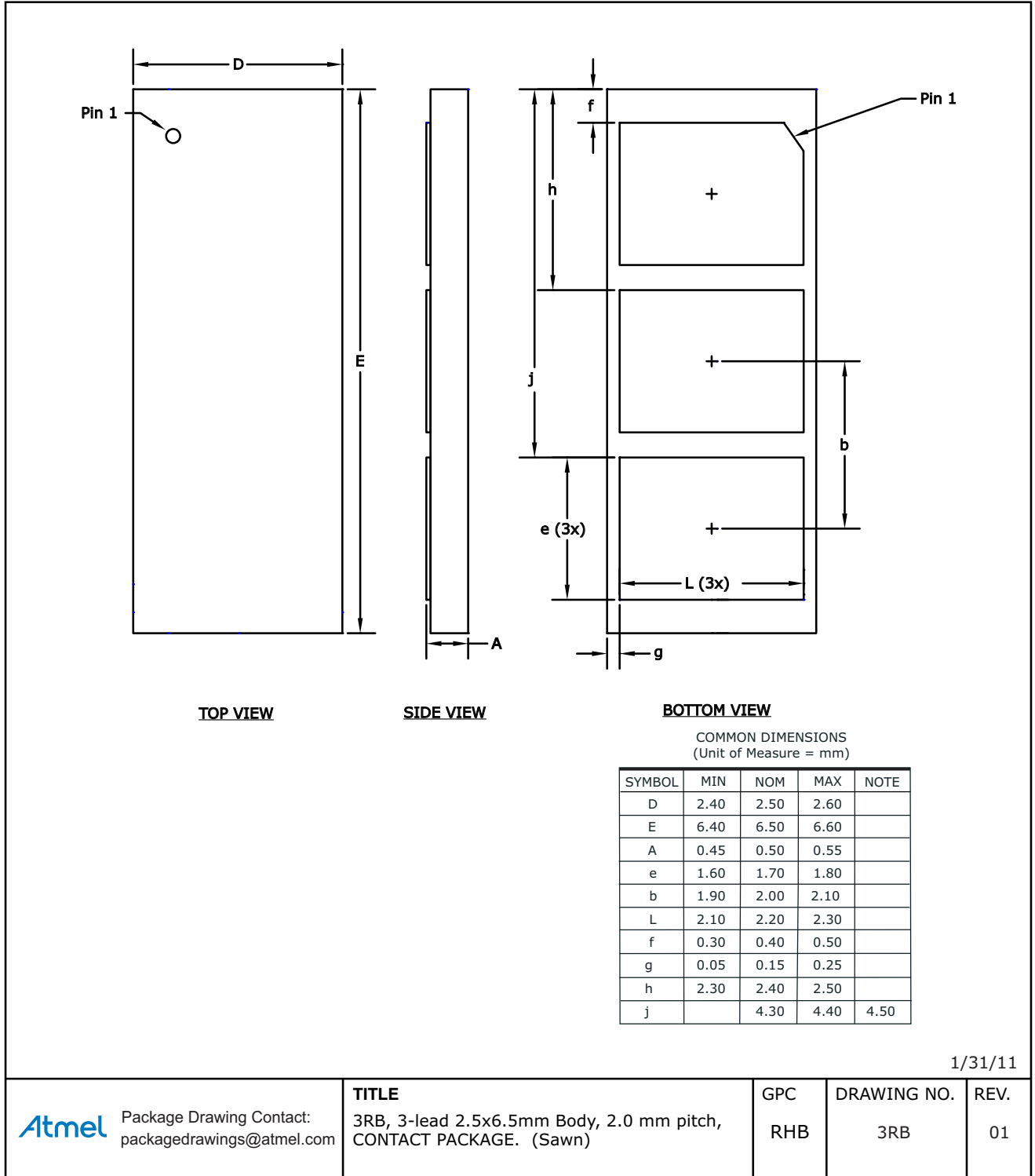

## 12. Ordering Information

Atmel Ordering Code <sup>(1)</sup>	Package Type	Interface Configuration
ATSHA204A-MAHCZ-T	8-pad UDFN, Tape and Reel	Single-Wire
ATSHA204A-MAHDA-T	8-pad UDFN, Tape and Reel	I <sup>2</sup> C
ATSHA204A-SSHCZ-T	8-lead SOIC, Tape and Reel	Single-Wire
ATSHA204A-SSHDA-T	8-lead SOIC, Tape and Reel	I <sup>2</sup> C
ATSHA204A-SSHDA-B	8-lead SOIC, Bulk in Tubes	I <sup>2</sup> C
ATSHA204A-MXHCZ-T	8-pad XDFN, Tape and Reel	Single-Wire
ATSHA204A-MXHDA-T	8-pad XDFN, Tape and Reel	I <sup>2</sup> C
ATSHA204A-XHCZ-T <sup>(2)</sup>	8-lead TSSOP, Tape and Reel	Single-Wire
ATSHA204A-XHDA-T <sup>(2)</sup>	8-lead TSSOP, Tape and Reel	I <sup>2</sup> C
ATSHA204A-STUCZ-T	3-lead SOT23, Tape and Reel	Single-Wire
ATSHA204A-RBHCZ-T	3-lead Contact, Tape and Reel	Single-Wire

- Notes:
1. The part number (Atmel ordering code) does *NOT* appear on the package. These packages are marked only with a manufacturing lot number which will likely change from shipment to shipment. So, do not use the package marking for any incoming inspection procedures.
  2. Not recommended for new design.

## 13. Reference and Application Notes

The ATSHA204A implements a challenge-response protocol using either SHA-256 or HMAC/SHA-256, details are noted below. The response is always a 256-bit digest.

The `Nonce` command (see [Section 8.5.12, “Nonce Command”](#)) accepts an input challenge from the system and optionally combines it with an internally generated random number to generate a nonce (i.e. number used once) for the calculation. The combination is the seed, and it is then combined with a secret key as part of the authentication calculation for any of the crypto commands (i.e. `MAC`, `HMAC`, `Read`, `Write`, or `GenDig`). The input challenge can also be passed directly to the `MAC` command.

The device can guarantee the uniqueness of the nonce only if the device has included the output of its RNG in the calculation; that is because the system input may or may not be unique. Every random nonce is in fact guaranteed to be unique when compared to all previous nonces, ensuring that each transaction is unique over all time.

### 13.1 SHA-256

The ATSHA204A `MAC` command calculates the digest of a secret key concatenated with the challenge or nonce. It optionally includes various other pieces of information stored on the device within the digested message.

The ATSHA204A computes the SHA-256 digest based on the algorithm documented at the following site:

<http://csrc.nist.gov/publications/fips/fips180-2/fips180-2.pdf>

The complete SHA-256 message processed by the ATSHA204A is listed in the command description for each command that use the algorithm. Most standard software implementations of the algorithm automatically add the appropriate number of pad and length bits to this message to match that the operation the device performs internally.

The ATSHA204A can also calculate a SHA-256 digest using the `SHA` command. The caller is responsible for providing the pad and length bytes to the message.

The SHA-256 algorithm is used for encryption by taking the output digest of the hash algorithm and XORing it with the plain text data to produce the ciphertext. Decryption is the reverse operation, namely the ciphertext is XORed with the digest with the result being the plain text.

### 13.2 HMAC/SHA-256

The response to the challenge can also be computed using the HMAC algorithm based on SHA-256 documented at the following site:

<http://csrc.nist.gov/publications/fips/fips198/fips-198a.pdf>

Because of the increased computation complexity, the HMAC command is not as flexible as the `MAC` command, and the computation time for HMAC is extended. While the HMAC sequence is not necessary to ensure the security of the digest, it is included for compatibility with various software packages.

### 13.3 Key Values

All keys within the `CryptoAuthentication` family are 256 bits long. The ATSHA204A uses these keys as part of the messages that are hashed with the `MAC`, `CheckMac`, `HMAC`, and `GenDig` commands. Any slot in the Data zone of the EEPROM can be used to store a key, however, the value will be secret only if the read and write permissions are properly set within `SlotConfig` (including the `IsSecret` bit).

Except for the `GenDig` command, all but the least-significant four bits of the `SlotID` parameter are ignored in determining the source of key data. Only the least-significant four bits are used to select one of the slots of the Data zone. See [Section 13.3.7, “Transport Keys”](#), for information on how `GenDig` uses other `SlotID` values.

In all cases for which a SHA-256 calculation is performed using `Param2`, the entire 16-bit `SlotID` as input is included in the message.

### 13.3.1 Diversified Keys

If the host or validating entity has a place to securely store secrets, the key values stored in the EEPROM slot(s) can be diversified with the serial number embedded in the device (SN[0:8]). In this manner, every Client device can have a unique key, which can provide extra protection against known plaintext attacks, and permit compromised serial numbers to be identified and blacklisted.

To implement this, a root secret is externally combined with the device's serial number during personalization using some cryptographic algorithm and the result written to the ATSHA204A key slot.

The ATSHA204A `CheckMac` command provides a mechanism of securely generating and comparing diversified keys, eliminating this requirement from the Host system.

Consult the following application note for more details:

[http://www.atmel.com/dyn/resources/prod\\_documents/doc8666.pdf](http://www.atmel.com/dyn/resources/prod_documents/doc8666.pdf)

### 13.3.2 Rolled Keys

In order to prevent repeated use of the same key value, the ATSHA204A supports key rolling. Normally, after a certain number of uses (perhaps as few as one), the current key value is replaced with the SHA-256 digest of its current value combined with some offset, which may either be a constant, something related to the current system (for example, a serial number or model number), or a random number.

This capability is implemented using the `DeriveKey` command. Prior to execution of the `DeriveKey` command, the `Nonce` command must be run to load the offset into `TempKey`. Each time the roll operation is performed on slots 0 thru 7, the `UpdateCount` field for that slot is incremented.

One use of this capability is to permanently remove the original key from the device, and replace it with a key that is only useful in a particular environment. After the key is rolled, there is no possible way to retrieve the old value, which improves the security of the system.

**Note:** Any power interruption during the execution of the `DeriveKey` command in Roll mode may cause either the key or the `UpdateCount` to have an unknown value. If writing to a slot is enabled using bit number 14 of `SlotConfig`, such keys can be written in encrypted and authenticated form using the `Write` command. Alternatively, multiple copies of the key can be stored in multiple slots so that failure of a single slot does not incapacitate the system.

### 13.3.3 Created Keys

In order to support unique ephemeral keys for every Client, the ATSHA204A also supports key creation. In this mechanism, a "parent" key (specified by `slotConfig.writeKey`) is combined with a fixed or random nonce to create a unique key, which is then used for any cryptographic purpose.

The ability to create unique keys is especially useful if the parent key has usage restrictions (see [Section 13.3.4, "Single-use Keys"](#) and [Section 13.3.5, "Limited-use Key"](#) in the following sections). In this mode, the limited use parent key can be employed to create an unlimited use child key. Because the child key is useful only for this particular Host-Client pair, attacks on its value are less valuable.

This capability is also implemented using the `DeriveKey` command. Prior to execution of the `DeriveKey` command, the `Nonce` command must be run to load the `Nonce` value into `TempKey`. Each time the create operation is performed on slots 0 thru 7; the `UpdateCount` field for that slot is incremented.

### 13.3.4 Single-use Keys

For the SlotID values corresponding to slots 0 thru 7 in the data section of the EEPROM, repeated usage of the key stored in the slot can be strictly limited. This feature is enabled if the SingleUse bit is set in the SlotConfig field. The SingleUse bit is ignored for slots 8 thru 14. The number of remaining uses is stored as a bit map in the UseFlag byte corresponding to the slot in question.

Prior to execution of any cryptographic command that uses this slot as a key, the following takes place:

- If SlotConfig[SlotID].SingleUse is set and UseFlag[SlotID] is 0x00, the device returns an error.
- Starting at bit 7 of UseFlag[SlotID], clear to zero the first bit that is currently a one.

In practice, this procedure permits SingleUse keys to be used eight times between “refreshes” using the DeriveKey command. If power is lost during the execution of any command referencing a key that has this feature enabled, one of the use bits in UseFlag may still be cleared even though the command did not complete. For this reason, Atmel recommends that the key be used a single time only, with the other bits providing a safety margin for errors.

Under normal circumstances, all eight UseFlag bytes should be initialized to 0xFF. If it is the intention to permit fewer than eight uses of a particular key, these bytes should be initialized to 0x7F (seven uses), 0x3F (six uses), 0x1F (five uses), 0x0F (four uses), 0x07 (three uses), 0x03 (two uses), or 0x01 (one use). Initialization to any other value besides these values or 0xFF is prohibited.

The Read, Write, and DeriveKey commands operate slightly differently as noted below:

- **Read and Write**

These commands ignore the state of the SingleUse bit and the UseFlag byte does not change as a result of their execution. SingleUse slots in which the UseFlag is exhausted (value of 0x00) can still be read or written (subject to the appropriate SlotConfig limitations) although the value in the slot cannot ever be used as a key for cryptographic commands.

If SlotConfig.WriteKey for slot X points back to X, but UseFlag[X] is exhausted, then encrypted writes to the slot will never succeed because the prior GenDig command will have returned an error due to the usage limitation. A similar situation occurs with reads and ReadKey. Slots used as keys should never have IsSecret set to zero or WriteConfig set to always.

- **DeriveKey**

If the parent key is used for either authentication or as the source, then if SingleUse (for the parent) is set and UseFlag (also for the parent) is 0x00, the DeriveKey command returns an error. The SingleUse and UseFlag bits are ignored for the target key. When successfully executed, DeriveKey always resets the UseFlag to 0xFF for the target key. This is the only mechanism to reset the UseFlag bits.

Use of the DeriveKey command is optional. It is legal to be run only if WriteConfig: 13 is set for this slot. In some situations, it may be advantageous to simply have a key that can be used eight times, in which case the other crypto commands will clear the bits in UseFlag one at a time until all are cleared, and at which time the key is disabled.

### 13.3.5 Limited-use Key

If Slot[15].SingleUse is set, usage of key number 15 is limited through a different mechanism than the single-use limitation described above, which applies only to slots 0 thru 7.

Prior to any use of key 15 by a cryptographic command, the following takes place:

- If all bytes in LastKeyUse are 0x00, return error.
- Starting at bit 7 of the first byte of LastKeyUse (byte 68 in the Configuration zone), clear to zero the first bit that is currently an one. If byte 68 is 0x00, check bit seven of byte 69, and so on up through byte 83. Only a single bit is cleared each time prior to using key 15.

There is no reset mechanism for this limitation; after 128 uses (or the number of one bits set in LastKeyUse on personalization), key 15 is permanently disabled. This capability is not susceptible to power interruptions. Even if the power is interrupted during execution of the command, only a single bit in LastKeyUse will be unknown; all other bits in LastKeyUse will be unchanged and the key will remain unchanged.

If fewer than 128 uses are desired for key 15, then some of the bytes within this array should not be initialized to 0xFF. As with UseFlag, the only legal values for bytes within this field (besides 0xFF) are 0x7F, 0x3F, 0x1F, 0x0F, 0x07, 0x03, 0x01, or 0x00. The total number of bits set to one indicates the number of uses.

**Example:** How to set 16 uses is as follows:

```
0xFF, 0xFF, 0x00, 0x00, 0x00, 0x00, 0x00, 0x00,  
0x00, 0x00, 0x00, 0x00, 0x00, 0x00, 0x00, 0x00.
```

The SingleUse bit is ignored by the Read and Write commands, and lastKeyUse does not change as a result of their execution. The SingleUse bit is ignored by the copy function of the CheckMac command. The SingleUse bit is honored for the parent key in the DeriveKey command, but is ignored for the target key.

### 13.3.6 Password Checking

Many applications require a user to enter a password to enable features, decrypt stored data, or to pursue some other purpose. Typically, the expected password has to be stored somewhere in memory and therefore can become, subject to discovery. The ATSHA204A can securely store the expected password and perform a number of useful operations on it. The password is never passed in the clear to the device, and it cannot be read from the device. It is hashed with a random number in the system software before being passed to the device. The nonce in TempKey must always have been generated using the internal RNG when a Transport Key is utilized.

The copy capability of the CheckMac command enables the following types of password checking options:

1. CheckMac does an internal comparison with the expected password and returns a Boolean to the system to indicate whether the password was correctly entered or not.
2. If the device determines that the correct password has been entered, then the value of the password can optionally be combined with a stored or ephemeral value to create a key that can be used by the system for data protection purposes.
3. If the device determines that the correct password has been entered, then the device can use this fact to optionally release a secondary high entropy secret, which can be used for data protection without the risk of an exhaustive dictionary attack.
4. If the password has been lost, an entity with knowledge of a parent key value can optionally write a new password into the slot. Optionally, the current value can be encrypted with a parent key and read from the device.

Passwords should be stored in even-numbered slots. If the password is to be mapped to a secondary value (use Step 3. above), then the target slot containing this value is located in the next higher slot number (the password slot number plus one); otherwise, the target slot is the same as the password slot.

ReadKey for the target slot must be set to zero to enable this capability. In order to prevent fraudulent or unintended usage of this capability, do not set ReadKey for any slot to zero unless this CheckMac/copy capability is specifically required. In particular, do not assume that other bits in the configuration word for a particular slot override the enablement of this capability specified by ReadKey = 0.

This capability is enabled only if the mode parameter to `CheckMac` has a value of `0x01` or `0x05` and `TempKey.SourceFlag` matches `Mode:Bit 2`.

**Note:** Care should be taken when using `Mode 0x05` as the system will be subject to a replay attack; however, there may be some system configurations in which this arrangement is advantageous.

- The first 32 bytes of the SHA-256 message are stored in a data slot in the EEPROM (the password).
- The second 32 bytes of the SHA-256 message must be a randomly generated nonce in the `TempKey` register.

If the above conditions are met and the input response matches the internally generated digest, then the contents of the target key are copied to `TempKey`. The other `TempKey` register bits are set as follows:

- `SourceFlag` is set to one (not random).
- `GenData` is set to zero (not generated by the `GenData` command).
- `CheckFlag` is set to zero (`TempKey` is not restricted to the `CheckMac` command).
- `Valid` is set to one.

### 13.3.7 Transport Keys

The ATSHA204A device includes an internal hardware array of keys (transport keys) that are intended for secure personalization prior to locking of the data section. The values of the hardware keys are kept secret, and are made available to qualified customers upon request to Atmel. These keys can be used with the `GenDig` command only, and are indicated by a `SlotID` value greater than or equal to `0x8000`.

For `GenDig` and all other commands, `SlotID` values less than `0x8000` always reference keys that are stored in the Data zone of the EEPROM. In these cases, only the four least-significant bits of `SlotID` are used to determine the slot number, while the entire 16-bit `SlotID` as input is used in any SHA-256 message calculation.



## 14. Revision History

Doc. Rev.	Date	Comments
8885G	06/2015	Update SOIC package drawing, remove first page note, and add images on cover and disclaimer page.
8885F	01/2015	Correct opcode name from GenDig to SHA in the SHA command input parameters table. Update the 8MA2 package outline drawing.
8885E	12/2014	The TSSOP option is not recommended for new design. Add additional compatibility bullet. Correct 3-lead SOT pinout diagram.
8885D	07/2014	Update Section, "Control Flags" to "Security Commands". Combine and update the Flag Value table into the I/O Flags table. Remove Section, "Wake Sequence" in the "Control Flags" section.
8885C	06/2014	Update Section, " $V_{IH}$ and $V_{IL}$ Specifications" and the 8MA2 package drawing. Add the 8MX1 package option.
8885B	05/2014	Clarify Section, "Reference and Application Notes". Update the 8S1 and 8MA2 package drawings. Update the Configuration Zone table, Word 0x03 and 0x04, under Byte 1. Combined $V_{IL}$ and $V_{IH}$ graphs. Update document status from Preliminary to Complete Release.
8885A	01/2014	Initial document release.



**Atmel** | Enabling Unlimited Possibilities®



**Atmel Corporation** 1600 Technology Drive, San Jose, CA 95110 USA T: (+1)(408) 441.0311 F: (+1)(408) 436.4200 | [www.atmel.com](http://www.atmel.com)

© 2015 Atmel Corporation. / Rev.: Atmel-8885G-CryptoAuth-ATSHA204A-Datasheet\_062015.

Atmel®, Atmel logo and combinations thereof, Enabling Unlimited Possibilities®, CryptoAuthentication™, and others are registered trademarks or trademarks of Atmel Corporation in U.S. and other countries. Other terms and product names may be trademarks of others.

**DISCLAIMER:** The information in this document is provided in connection with Atmel products. No license, express or implied, by estoppel or otherwise, to any intellectual property right is granted by this document or in connection with the sale of Atmel products. EXCEPT AS SET FORTH IN THE ATMEL TERMS AND CONDITIONS OF SALES LOCATED ON THE ATMEL WEBSITE, ATMEL ASSUMES NO LIABILITY WHATSOEVER AND DISCLAIMS ANY EXPRESS, IMPLIED OR STATUTORY WARRANTY RELATING TO ITS PRODUCTS INCLUDING, BUT NOT LIMITED TO, THE IMPLIED WARRANTY OF MERCHANTABILITY, FITNESS FOR A PARTICULAR PURPOSE, OR NON-INFRINGEMENT. IN NO EVENT SHALL ATMEL BE LIABLE FOR ANY DIRECT, INDIRECT, CONSEQUENTIAL, PUNITIVE, SPECIAL OR INCIDENTAL DAMAGES (INCLUDING, WITHOUT LIMITATION, DAMAGES FOR LOSS AND PROFITS, BUSINESS INTERRUPTION, OR LOSS OF INFORMATION) ARISING OUT OF THE USE OR INABILITY TO USE THIS DOCUMENT, EVEN IF ATMEL HAS BEEN ADVISED OF THE POSSIBILITY OF SUCH DAMAGES. Atmel makes no representations or warranties with respect to the accuracy or completeness of the contents of this document and reserves the right to make changes to specifications and products descriptions at any time without notice. Atmel does not make any commitment to update the information contained herein. Unless specifically provided otherwise, Atmel products are not suitable for, and shall not be used in, automotive applications. Atmel products are not intended, authorized, or warranted for use as components in applications intended to support or sustain life.

**SAFETY-CRITICAL, MILITARY, AND AUTOMOTIVE APPLICATIONS DISCLAIMER:** Atmel products are not designed for and will not be used in connection with any applications where the failure of such products would reasonably be expected to result in significant personal injury or death ("Safety-Critical Applications") without an Atmel officer's specific written consent. Safety-Critical Applications include, without limitation, life support devices and systems, equipment or systems for the operation of nuclear facilities and weapons systems. Atmel products are not designed nor intended for use in military or aerospace applications or environments unless specifically designated by Atmel as military-grade. Atmel products are not designed nor intended for use in automotive applications unless specifically designated by Atmel as automotive-grade.